



CATALOGO LISTINO 34



PER NOI IL BAGNO
È LA STANZA DEL BENESSERE
E IL BENESSERE NON CAPITA,
SI CREA.

PRODOTTO ITALIANO



AZIENDA, PRODUTTORI.

Produciamo accessori da bagno e soluzioni d'arredo dal 1978.

Sono prodotti artigianali che nascono dai progetti di designers affermati, dalle nostre idee e dall'esperienza dei nostri collaboratori. Ci piace chiamarli "necessari per il bagno" perché, con le loro funzioni essenziali e insostituibili, garantiscono la qualità del benessere nella stanza da bagno.

Con una gamma di oltre 2000 prodotti, proponiamo soluzioni funzionali e collaborazione progettuale per valorizzare e soddisfare le esigenze del cliente. Manteniamo il prestigio del Made in Italy, grazie alla creatività e alle capacità individuali connesse ad un indotto di aziende italiane affidabili e consolidate.

COMPANY, PRODUCERS

We are bathroom accessories and furnishing solutions producers since 1978.

Our artisanal products arise from designers, our ideas and the experience of our collaborators. We like to call them "bathroom essentials" because, they guarantee the quality of well-being in the bathroom. With a range of over 2000 products, we offer functional solutions to and satisfy all customer needs. We maintain the prestige of Made in Italy, thanks to the creativity and individual skills connected to a consolidated Italian companies network.

NECESSARI PER IL BAGNO

I motivi per collaborare con noi:

- Siamo produttori e realizziamo nel nostro stabilimento le proposte standard e personalizzate
- Siamo attenti alle nuove finiture per abbinarci alle rubinetterie
- Siamo una squadra di professionisti della produzione artigianale, del marketing e dell'amministrazione
- Siamo rapidi nella realizzazione e nelle consegne
- Siamo a disposizione per consulenze tecniche e soluzioni razionali
- Siamo in grado di garantire i nostri prodotti per 5 anni
- Siamo disponibili ad ogni chiarimento sulla consultazione del nostro catalogo e del configuratore on line

In nostro catalogo vuole essere uno strumento di vendita concreto ed efficace.

NECESSARY FOR THE BATHROOM

The reasons to collaborate with us:

- We are producers and brass manufacturers. IN our factory we can customize on the single customer needs.
- We are attentive to the new finishes to coordinate with the faucets.
- We are a team of professional artisans, marketing and administration managers.
- We are quick to manufacture and deliver.
- We are available for technical customer service.
- We are able to guarantee our products for 5 years
- We are available to any clarification on consulting our catalog and online configurator

Our catalog is a useful sales tool, expressing business concreteness and efficiency.



QUALITÀ, PASSIONE PER L'OTTONE

I nostri prodotti sono realizzati con materiali di prima qualità e produzione italiana e sono sottoposti a trattamenti che ne garantiscono la resistenza alla corrosione e la durata nel tempo. Un accurato controllo e verifica dell'assemblaggio, forte della nostra lunga esperienza, permettono di dare a questi prodotti una garanzia di 5 anni dalla data di acquisto, comprovata da un documento fiscale rilasciato dal negoziante. Sono esclusi tutti i difetti derivanti da uso ed installazione impropri, errati o successivi interventi sul prodotto non autorizzati.



QUALITY, PASSION FOR BRASS

Our products are made with top quality materials with Italian production. The articles are subjected to treatments that guarantee their resistance to corrosion and durability over time. An accurate control and verification after the assembly chain, allows us to give these products a 5-year guarantee from the date of purchase with a correct installation and cleaning method.



08
Cromo
Chrome



17
Oro Rosa
Pink gold



27
Bronzo Opaco
Matt bronze



09
Ottone naturale
Natural Brass



18
Oro Opaco
Matt gold



28
Bronzo Scuro opaco
Dark matt bronze



10
Ottone naturale verniciato lucido
Natural painted brass



19
Oro Inglese
English gold



36
Nickel satinato lucido
Shiny satin nickel



12
Nickel lucido verniciato lucido
Polish nickel



23
Nero Opaco
Matt black



37
Nickel satinato opaco
Shiny satin nickel



14
Oro chiaro champagne opaco
Champagne matt gold



24
Bianco Opaco
Matt white



56
Nickel nero lucido
Matt satin nickel



15
Oro Satinato
Satin gold



25
Bronzo
Bronze



57
Nickel nero satinato lucido
Black shiny satin nickel



16
Oro Lucido
Gold



26
Rame satinato
Satin copper



61
Nickel nero satinato opaco
Black matt satin nickel

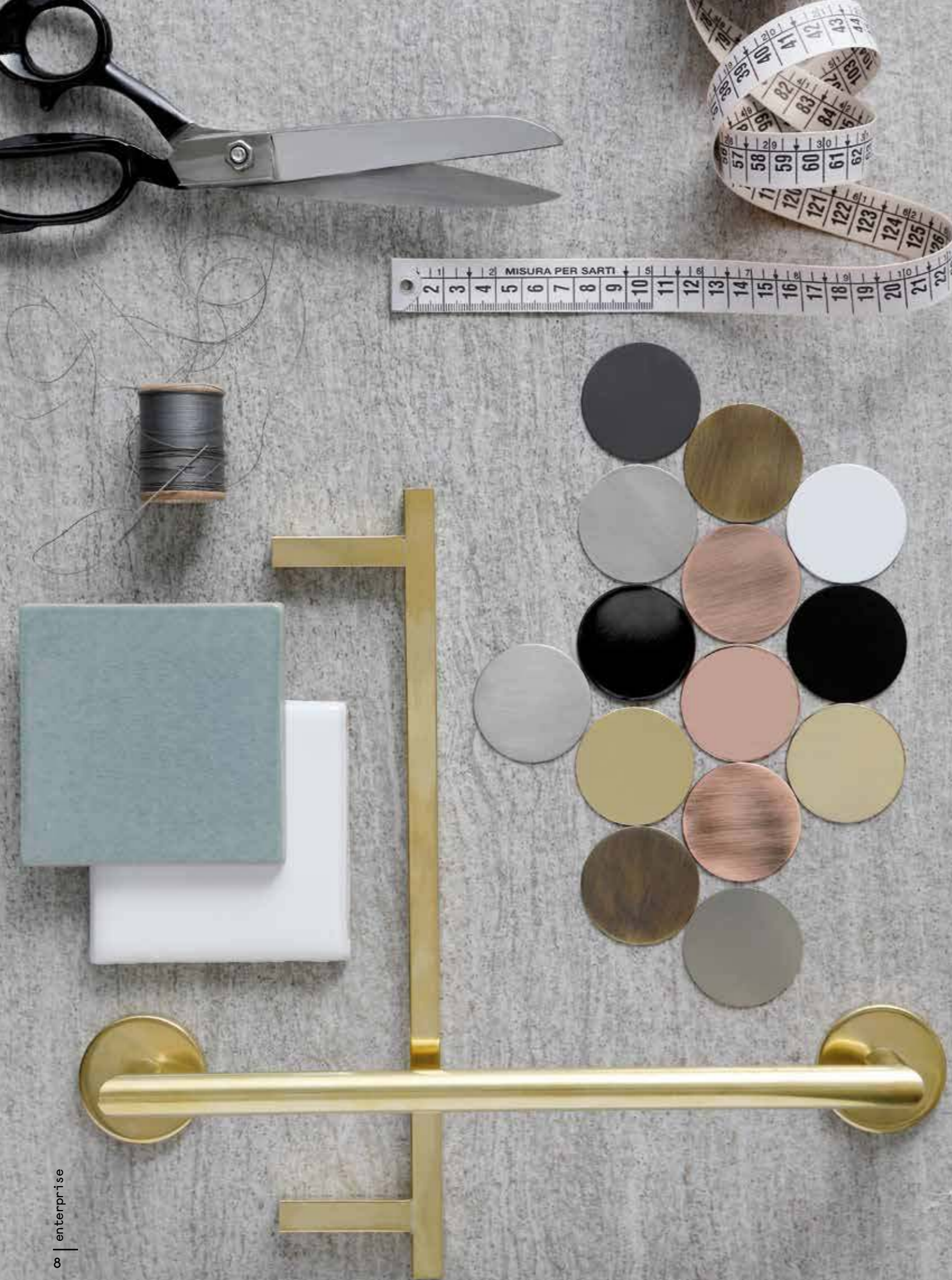

PROGETTO SARTORIA

Il progetto sartoria è la possibilità di scegliere e personalizzare i nostri prodotti secondo le esigenze specifiche del cliente. I simboli posti accanto alle nostre collezioni o ai nostri specchi indicano tutte le possibilità di scelta:



SU MISURA al centimetro
Per personalizzare ACCESSORI e SPECCHI



FINITURE abbinabili
Per coordinare gli ACCESSORI alle rubinetterie

TAILORING PROJECT

The tailoring project is the possibility to choose and customize our products according to the specific needs of the customer. The symbols placed next to our collections or our mirrors indicate all the possibilities of choice:



CUSTOMIZED on size
ACCESSORIES and MIRRORS customization



Matching FINISHES
To match ACCESSORIES with taps colors

Progetto sartoria ACCESSORI IN FINITURA

Proponiamo 6 collezioni, Hashi, Medea, Rail, Urania, Equilibrium, Elite, per le quali è prevista la realizzazione di una finitura in abbinamento alle rubinetterie.

Con il simbolo  indichiamo la possibilità di scegliere il colore che realizziamo con trattamento galvanico o PVD in 20 o 40 giorni.



ELITE

CUSTOMIZED FINISHES

We offer 6 collections where you can have a big range of matchable finishes with taps.

With the symbol  we indicate the possibility to choose the color that we can produce with galvanic or PVD treatment in 20 or 40 days



HASHI



MEDEA



RAIL



URANIA

Progetto sartoria ACCESSORI SU MISURA

Proponiamo 17 collezioni per le quali è prevista la realizzazione di accessori su misura al centimetro

Con il simbolo  indichiamo la possibilità di richiedere le misure specifiche e alla fine di ogni collezione, il costo e i tempi di evasione.



CUSTOMIZED ACCESSORIES

We offer 17 collections where you have customization on size.

With the symbol  we indicate the possibility of requesting specific measurements and at the end of each collection pages you have the cost and processing times.

Progetto sartoria SPECCHI

Proponiamo la personalizzazione dalle minime fino alle grandi dimensioni, a filo lucido o molati, rettangolari o tondi, sagomati o a disegno.

Su ognuno è possibile scegliere l'optional secondo le esigenze del cliente: retroilluminazione, posizionamento del led, gradazione e intensità; interruttori a misura, bluetooth o antiappannamento; specchi ingranditori integrati.

Con il CONFIGURATORE dal sito web, si può comporre il proprio specchio, conoscere il costo e ottenere un render.

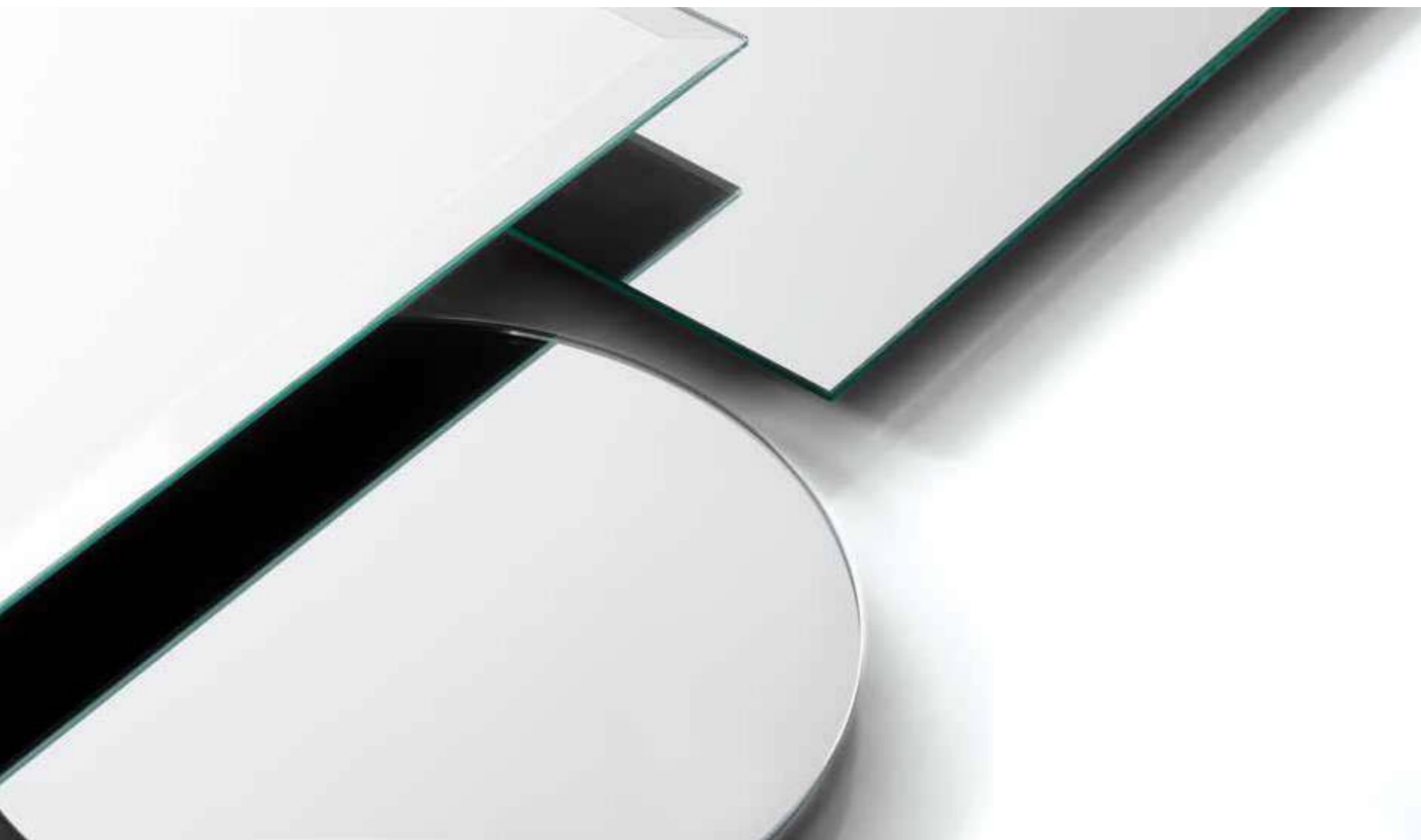

CUSTOMIZED ACCESSORIES

We offer customization for different sizes of mirrors with polished or ground edges. Regular, round or shaped to your design. On each one it is possible to choose the optional according to the customer's needs: backlighting, LED positioning, gradation and intensity; customized switches, Bluetooth or anti-fog; integrated magnifying mirrors. With the CONFIGURATOR in our website, you can compose your own mirror to know the cost and have a immediate 3D example image.



CORPORATE AZIENDALE

I nostri ambiti operativi si strutturano in management, commerciale, amministrativo, produzione, customer, studio e progettazione. Strategie di consolidamento e sviluppo del mercato nazionale ed estero.

Our company team is composed into management, commercial, administrative, production, customer, study and design. Consolidation and development strategies for the national and foreign market.

Comunicazioni
stilhaus@stilhaus.it

Ufficio commerciale Italia
ordini@stilhaus.it

Ufficio commerciale Estero
export@stilhaus.it



Amministrazione
amministrazione@stilhaus.it

Spedizioni
fatturazione@stilhaus.it

DESIGNERS



STILHAUS
easy, diana, gea, medea,
mizar, saturno, urania, elite,
giunone, marte,
nemi, prisma, regal, smart,
smart light



CLAUDIO PAPA
zefiro, quid



MARKUS BINZ
rack



MASSIMILIANO SETTIMELLI
aria, diva, lui & lei,
totem, liz



GIANLUCA PALUDI
hashi, eco, dorian,
step-box, equilibrium



PAOLO GALLETTI E DANIELE MALTINTI
krea



GIOVANNA TALOCCI E MARCO PALLOCCA
rail, fold, bucket



BGR INDUSTRIAL DESIGN
living



ERVAS BASILICO GIRARDI
milano

LETTURA CATALOGO

ACCESSORI

tipo erogatore/ pump type

A 

foto prodotto/ product photo

codice / code

reversibile su richiesta/ reversible on request

LV 69 D

descrizione / description

Asta con dosatore sapone
Towel rail with liquid soap dispenser
Porte serviettes avec dosator de savon
Handtuchring mit Seifenspender
Полотенцедержатель + керамический дозатор
cm 35 L x 7 P x 21 H - INT. 30

dimensioni / dimensions

finiture / finishes

prezzo / price

• 08 - 03 - 05	€ 160,00
• 08 A - 03 A - 05 A	€ 145,00

ILLUMINAZIONE

1134 SP

Applique per specchio a led
Led mirror lamp
Lampe a Led pour miroir
LED Leuchte für Spiegel
Светодиодный настенный светильник для зеркала
cm 30 L X 11 P X 4,5 H
CE : V 220 IP 44 4,8W 4000K

caratteristiche LED / LED details

• 08	€ 89,00
• 23	€ 94,00
• 3000K	maggiorazione / supplement supplément / Zuschlag дополнительно € 30,00

tipologia fissaggio / type of connection

D 1 2 3 4 5

23

finitura / finish





SIMBOLOGIA

ACCESSORI

-  Possibilità di fissaggio ad incollo / Possibility of installation by glue
-  FINITURE / FINISHES
-  REVERSIBILE SU RICHIESTA / REVERSIBLE ON REQUEST
-  PERSONALIZZAZIONE MISURE / SIZES CUSTOMIZATIONS
-  OPZIONI / OPTIONALS
-  FINITURE ABBINABILI / MATCHABLE PRODUCTS
-  CORRELATI / RELATED ITEMS

SPECCHI E ILLUMINAZIONE

- +** **P V Q R S U** OPTIONALS
 -  SU MISURA / SIZE CUSTOMIZATION
 - A** INTERRUTTORE / SWITCH
 - D** TIPOLOGIA DI ATTACCO ILLUMINAZIONE / TYPE OF LIGHTING CONNECTION
- 
1

2



3

4



5
- LAMPADA ABBINABILE AD INTERRUTTORI (V) - (V2) - (P)
- HQC** HQC PRODOTTO ESTERNO CON CONTROLLO DI QUALITÀ
high quality control for external production

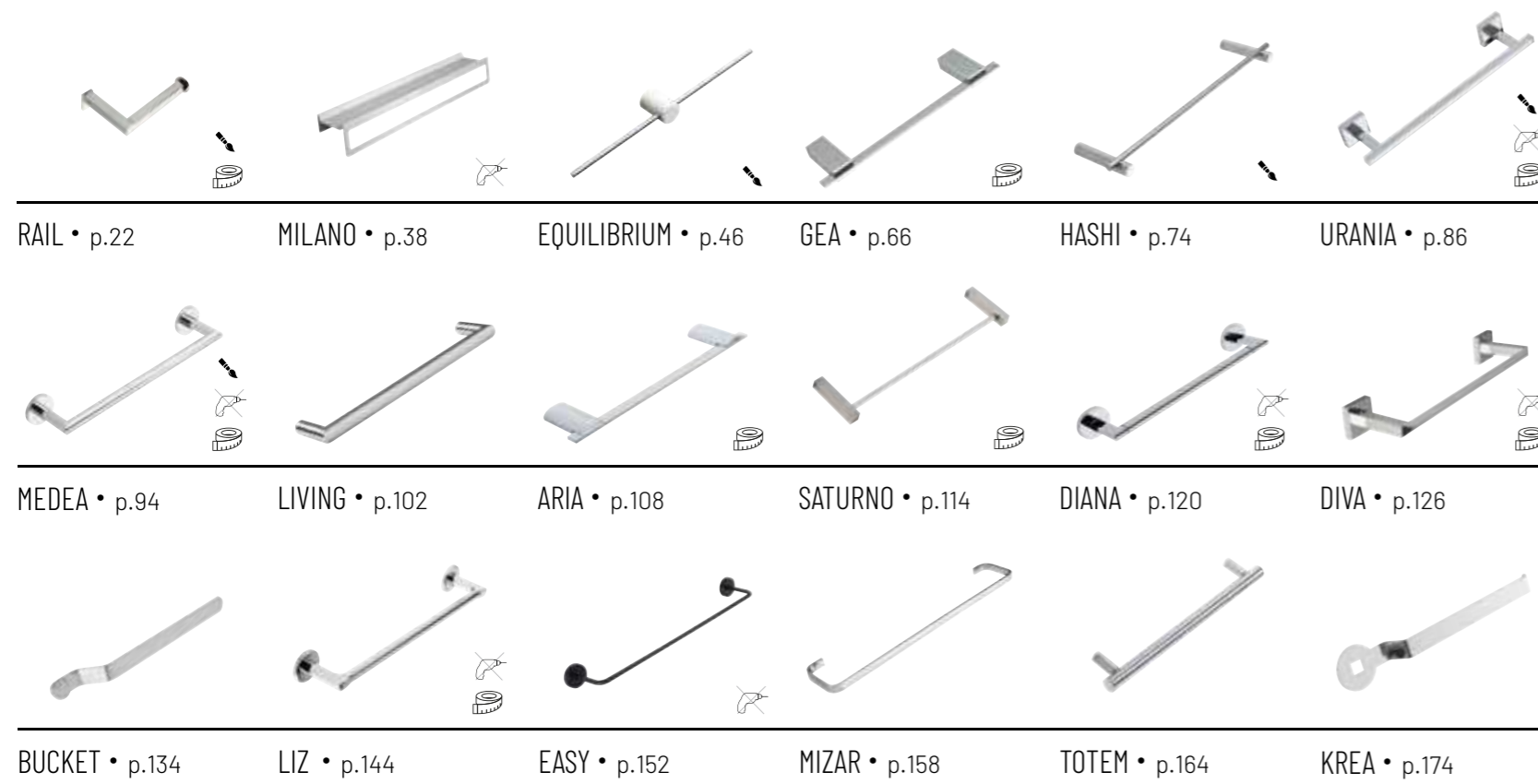

DESIGN COLLECTIONS

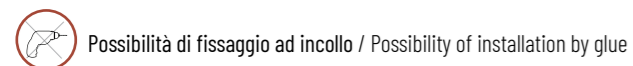

CLASSIC COLLECTIONS



SPECCHI • MIRRORS



COMPLEMENTI • FINISHING ACCESSORIES

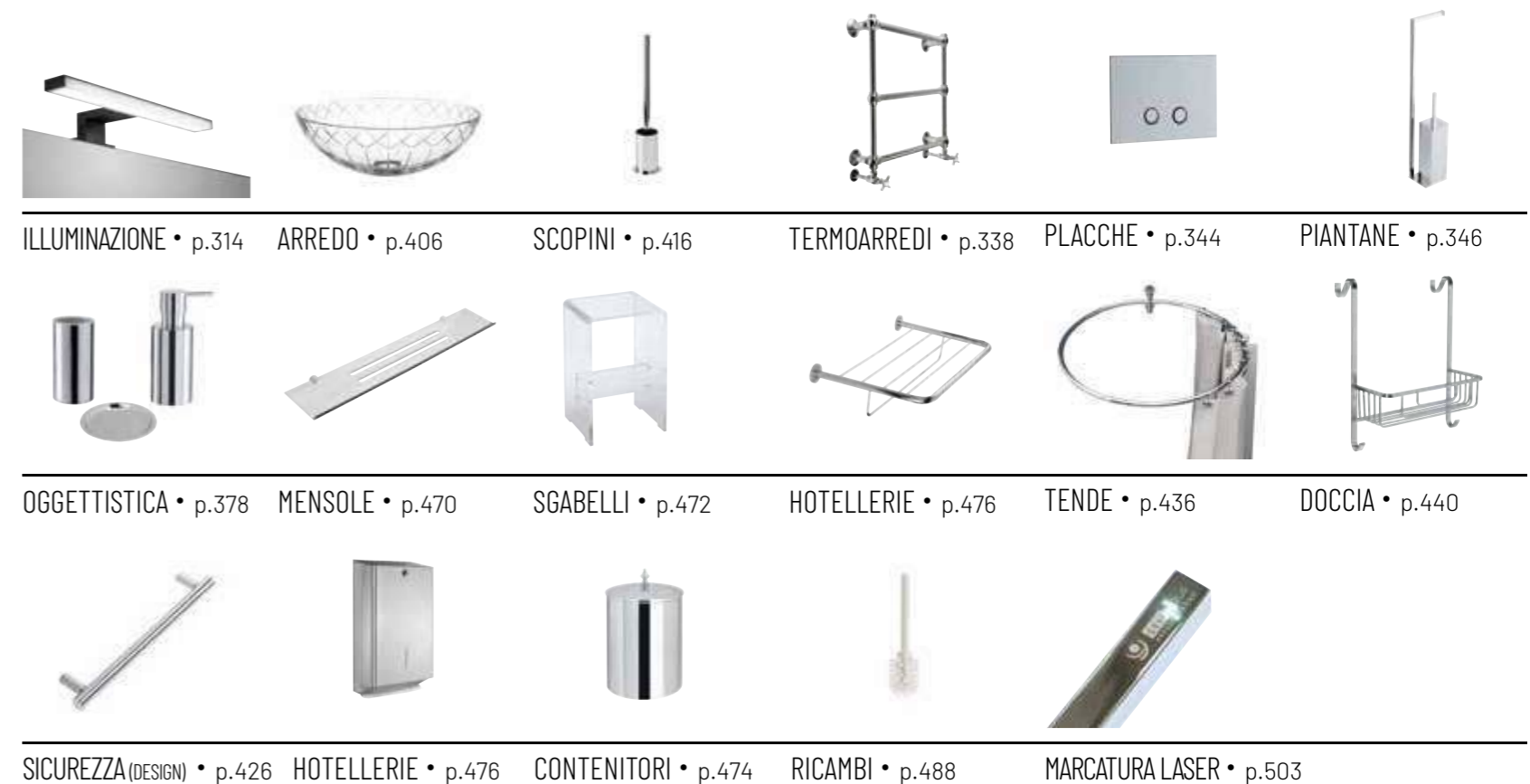

p.494 ESPOSITORI
Exhibitors / Exposants / Ausstellungsstände / Экспозиторы

p.496 CONDIZIONI DI VENDITA
Terms of sale / Conditions de vente / Verkaufsbedingungen / условия продажи

RAIL

Designer: GIOVANNA TALOCCI, MARCO PALLOCCA

Materiale: Ottone
Accessori: Ocritech, Multistrato marino, Marmo bianco, Vetro
Finiture: 08, 10, 23, 36
Personalizzazione: Sì

Material: Solid Brass
Accessories: Ocritech, Wood, White marble, Glass
Finishes: 08, 10, 23, 36
Customized: Yes

Matériel: Laiton massif
Accessoires: Ocritech, Bois, Marbre blanc, Verre
Finitions: 08, 10, 23, 36
Personnalisé: Oui

Material: Messing bar
Zubehör: Ocritech, Holz, Weißer Marmor, Glas
Ausführungen: 08, 10, 23, 36
Kundenwunsch: Ja

Материал: латунь
Аксессуары: Окритек, морская фанера, белый мрамор, стекло.
Покрытие: 08, 10, 23, 36
Негабаритный: да

RAIL



RL 75 08

RAIL



RL 11 T 08



RL 72 08



RL 06 36

EUROPEAN
PRODUCT
DESIGN
AWARD





SOL3



SOL 4



SOL 1



SOL2



SOL 1 cm 46 L x 80 H

- 08 - 10 - 23 + Legno - Ocritech - Marmo* € 303,00
- 36 + Legno - Ocritech - Marmo* € 395,00



SOL 2 cm 76 L x 80 H

- 08 - 10 - 23 + Legno - Ocritech - Marmo* € 389,00
- 36 + Legno - Ocritech - Marmo* € 495,00
- * Legno - Ocritech € 40,00
- * Marmo bianco € 120,00



SOL 3 cm 84 L

- 08 - 10 - 23 + Legno - Ocritech - Marmo* € 350,00
- 36 + Legno - Ocritech - Marmo* € 434,00
- * Legno - Ocritech € 125,00
- * Marmo bianco € 285,00



SOL 4 cm 126 L x 16 H

- 08 - 10 - 23 + Legno - Ocritech - Marmo* € 329,00
- 36 + Legno - Ocritech - Marmo* € 422,00
- * Legno - Ocritech € 50,00
- * Marmo bianco € 120,00

08-10-23-36 prezzi compresi di accessori / 08-10-23-36 prices including accessories / 08-10-23-36 prix incluant les accessoires / 08-10-23-36 Preise inklusive Zubehör / 08-10-23-36 цены, включая аксессуары

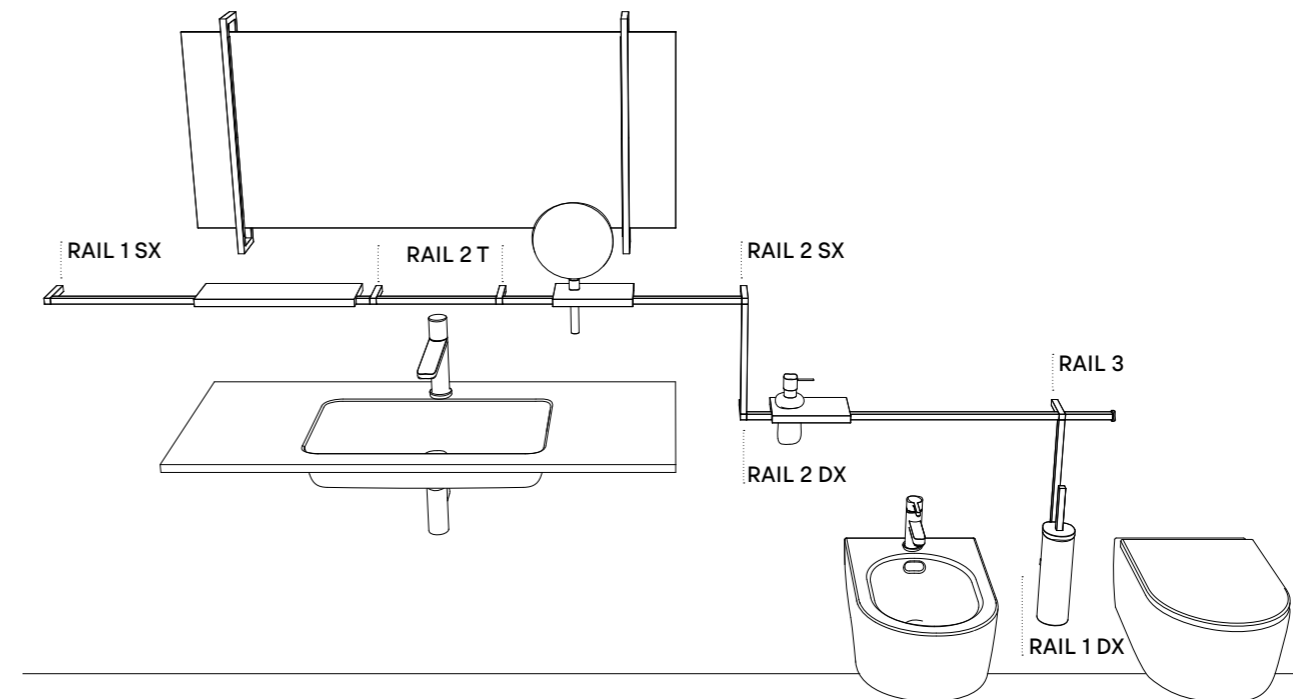

ESEMPIO
EXAMPLE
EXEMPLE
BEISPIEL
Пример



- RAIL 1 DX € 29,00
- RAIL 1 SX € 29,00
- RAIL 05 € 54,00
- RAIL 20.1 OCRITECH € 50,00
- RAIL 037 08 € 74,00
- TOT € 236,00



RL 08 C

Asta cm 80
80 cm rod
tige de 80 cm
80 cm Stange
стержень 80 см
cm 83,2 L x 9,5 P x 1,5 H

• 08 - 23	€ 125,00
• 10 - 36	€ 165,00
• FN	€ 185,00



RL 05 C

Asta cm 60
60 cm rod
tige de 60 cm
60 cm Stange
стержень 60 см
cm 63,2 L x 9,5 P x 1,5 H

• 08 - 23	€ 115,00
• 10 - 36	€ 155,00
• FN	€ 170,00



RL 45 C

Asta cm 45
45 cm rod
tige de 45 cm
45 cm Stange
стержень 45 см
cm 48,2 L x 9,5 P x 1,5 H

• 08 - 23	€ 99,00
• 10 - 36	€ 135,00
• FN	€ 150,00



RL 06 C

Asta cm 30
30 cm rod
tige de 30 cm
30 cm Stange
стержень 30 см
cm 33,2 L x 9,5 P x 1,5 H

• 08 - 23	€ 95,00
• 10 - 36	€ 125,00
• FN	€ 145,00



RL 09 R

Porta sapone a parete in neolite
Wall-mounted soap holder in neolite
Porte-savon mural en néolite
Wandseifenhalter aus Neolite
Настенный держатель для мыла из неолита
cm x L 10,5 x 12P x 7 H

• 08 - 23	€ 125,00
• 10 - 36	€ 160,00
• FN	€ 185,00



RL 10 R

Porta bicchiere a parete in neolite
Wall-mounted cup holder in neolite
Porte-verre mural en néolite
Wandbecherhalter aus Neolite
Настенный держатель для стакана из неолита
cm x L 7,5 x 9P x 14 H

• 08 - 23	€ 135,00
• 10 - 36	€ 175,00
• FN	€ 198,00



RL 30 R

Dosatore sapone a parete in neolite
Wall-mounted soap dispenser in neolite
Distributeur de savon mural en néolite
Seifenspender an der Wand aus Neolite
Настенный диспенсер для мыла из неолита
cm x L 7,5 x 9P x 14 H

• 08 - 23	€ 200,00
• 10 - 36	€ 260,00
• FN	€ 300,00



RL 72

Asta cm 60 con dosatore e rotolo
60 cm rod with dispenser and roll
tige de 60 cm avec distributeur et rouleau
60 cm langer Stab mit Spender und Rolle
Штанга 60 см с дозатором и валиком
cm 75,7 L x 12 P x 13 H

• 08 - 23 + Legno - Ocritech - Marmo*	€ 190,00 +
• 10 - 36 + Legno - Ocritech - Marmo*	€ 250,00 +
• FN	€ 260,00 +
+ Legno - Ocritech	€ 50,00
+ Marmo bianco	€ 120,00



RL 69

Asta cm 60 con dosatore
60 cm rod with dispenser
tige de 60 cm avec distributeur
60 cm langer Stab mit Spender und Glas
Штанга 60 см с дозатором
cm 63,2 L x 12 P x 13 H

• 08 - 23 + Legno - Ocritech - Marmo*	€ 185,00 +
• 10 - 36 + Legno - Ocritech - Marmo*	€ 240,00 +
• FN	€ 278,00 +
+ Legno - Ocritech	€ 50,00
+ Marmo bianco	€ 120,00



RL 70

Asta cm 60 con bicchiere
Rod cm 60 with glass
Tige cm 60 avec verre
60 cm langer Stab mit Spender und Glas
Стержень см 60 со стеклом
cm 63,2 L x 12 P x 11 H

• 08 - 23 + Legno - Ocritech - Marmo*	€ 145,00 +
• 10 - 36 + Legno - Ocritech - Marmo*	€ 185,00 +
• FN	€ 220,00 +
+ Legno - Ocritech	€ 50,00
+ Marmo bianco	€ 120,00



RL 71

Asta cm 60 con dosatore e bicchiere
60 cm rod with dispenser and glass
tige de 60 cm avec distributeur et verre
60 cm langer Stab mit Spender und Glas
Штанга 60 см с дозатором и стаканом
cm 63,2 L x 12 P x 13 H

• 08 - 23 + Legno - Ocritech - Marmo*	€ 210,00 +
• 10 - 36 + Legno - Ocritech - Marmo*	€ 255,00 +
• FN	€ 315,00 +
+ Legno - Ocritech	€ 55,00
+ Marmo bianco	€ 135,00



RL 04

Asta cm 60 con mensola
60 cm shaft with handle
manche de 60 cm avec poignée
22 cm Stiel mit Griff
Вал 60 см с ручкой
cm 63,2 L x 12 P x 2 H

• 08 - 23 + Legno - Ocritech - Marmo*	€ 115,00 +
• 10 - 36 + Legno - Ocritech - Marmo*	€ 148,00 +
• FN	€ 170,00 +
+ Legno - Ocritech	€ 65,00
+ Marmo bianco	€ 130,00



RL 73

Asta cm 30 con rotolo
30 cm shaft with rotolo
Arbre de 30 cm avec rotolo
30 cm langer Schaft mit Rotolo
30 cm langer Schaft mit Rotolo
cm 48,2 L x 9,5 P x 1,5 H

• 08 - 23	€ 147,00
• 10 - 36	€ 195,00
• FN	€ 220,00



RL 13

Porta accappatoio
Robe hook
Porte peignoir
Bademantelhaken
Крючок
cm 2,8 L x 4,5 P x 2,8 H

• 08 - 23	€ 38,00
• 10 - 36	€ 47,00
• FN	€ 57,00



RL 11.T

Porta rotolo singolo
Single roll holder
Porte-rouleau unique
Einzelner Rollenhalter
Одноместный держатель рулона
cm 14,3 L x 9,5 P x 5 H

• 08 - 23	€ 78,00
• 10 - 36	€ 99,00
• FN	€ 118,00



RL 11V

Porta rotolo singolo
Single roll holder
Porte-rouleau unique
Einzelner Rollenhalter
Одноместный держатель рулона
cm 2 L x 11 P x 2 H

• 08 - 23	€ 42,00
• 10 - 36	€ 55,00
• FN	€ 63,00



RL 10

Asta cm 22 con bicchiere
Rod cm 22 with glass
Tige cm 22 avec verre
Stab cm 22 mit Glas
Стержень см 22 со стеклом
cm 25,2 L x 12 P x 11 H

• 08 - 23 + Legno - Ocritech - Marmo*	€ 105,00 +
• 10 - 36 + Legno - Ocritech - Marmo*	€ 130,00 +
• FN	€ 155,00 +
+ Legno - Ocritech	€ 50,00
+ Marmo bianco	€ 120,00



RL 14

Asta cm 22 con dosatore e bicchiere
22 cm rod with dispenser and glass
tige de 22 cm avec distributeur et verre
22 cm langer Stab mit Spender und Glas
Штанга 22 см с дозатором и стаканом
cm 25,2 L x 12 P x 13 H

• 08 - 23 + Legno - Ocritech - Marmo*	€ 160,00 +
• 10 - 36 + Legno - Ocritech - Marmo*	€ 200,00 +
• FN	€ 240,00 +
+ Legno - Ocritech	€ 55,00
+ Marmo bianco	€ 130,00



RL 30

Asta cm 22 con dosatore
22 cm rod with dispenser
tige de 22 cm avec distributeur
22 cm langer Stab mit Spender
Штанга 2 см с дозатором
cm 25,2 L x 12 P x 13 H

• 08 - 23 + Legno - Ocritech - Marmo*	€ 130,00 +
• 10 - 36 + Legno - Ocritech - Marmo*	€ 170,00 +
• FN	€ 195,00 +
+ Legno - Ocritech	€ 50,00
+ Marmo bianco	€ 120,00



RL 74

Asta cm 22 con mensola
22 cm shaft with handle
manche de 22 cm avec poignée
22 cm Stiel mit Griff
Вал 22 см с ручкой
cm 25,2 L x 12 P x 2 H

• 08 - 23 + Legno - Ocritech - Marmo*	€ 80,00 +
• 10 - 36 + Legno - Ocritech - Marmo*	€ 110,00 +
• FN	€ 120,00 +
+ Legno - Ocritech	€ 45,00
+ Marmo bianco	€ 75,00



RL 75

Porta scopino con rotolo
Toilet brush holder with roll
Porte-brosse de toilette avec rouleau
Klobbürstenhalter mit Rolle
Держатель туалетной щетки с валиком
cm 15 L x 17,5 P x 80 H

• 08 - 23	€ 230,00
• 10 - 36	€ 300,00
• FN	€ 345,00



RL 039

Porta scopino da appoggio
Toilet-brush with base
Porte balayent d'appui
Bürstengarnitur freistehend
Напольный металлический ёрш
cm 8 L x 8 P x 40 H

• 08 - 23	€ 89,00
• 10 - 36	€ 113,00
• FN	€ 134,00

**RL 08**

Asta cm 80
Rod cm 80
Canne cm 80
Stange cm 80
Вал см 80
cm 80 L

• 08 - 23	€ 65,00
• 10 - 36	€ 82,00

**RL 05**

Asta cm 60
Rod cm 60
Canne cm 60
Stange cm 60
Вал см 60
cm 60 L

• 08 - 23	€ 56,00
• 10 - 36	€ 72,00

**RL 45**

Asta cm 45
Rod cm 45
Canne cm 45
Stange cm 45
Вал см 45
cm 45 L

• 08 - 23	€ 44,00
• 10 - 36	€ 56,00

**RL 06**

Asta cm 30
Rod cm 30
Canne cm 30
Stange cm 30
Вал см 30
cm 30 L

• 08 - 23	€ 44,00
• 10 - 36	€ 56,00

**RL 20**

Mensola cm 20
Shelf
Étagère
Ablage
Полка см 20
cm 20 L x 12 P

• Legno - Ocritech	€ 45,00
• Marmo bianco	€ 75,00

**RL 20.1**

Mensola cm 20 con 1 foro
Shelf with 1 hole
Étagère avec 1 trou
Ablage mit 1 loch
Полка 20 см с 1 отверстием
cm 20 L x 12 P

• Legno - Ocritech	€ 50,00
• Marmo bianco	€ 120,00

**RL 20.2**

Mensola cm 20 con 2 fori
Shelf with 2 hole
Étagère avec 2 trou
Ablage mit 2 loch
Полка 20 см с 2 отверстиями
cm 20 L x 12 P

• Legno - Ocritech	€ 55,00
• Marmo bianco	€ 130,00

**RL 20.3**

Mensola cm 20 con 1 foro specchio
Shelf with 1 hole for mirror
Étagère avec 1 trou pour miroir
Ablage mit 1 loch für spiegel
Полка 20 см с 1 зеркальным отверстием
cm 20 L x 12 P

• Legno - Ocritech	€ 50,00
• Marmo bianco	€ 120,00

**RL 11**

Asta cm 12, anche per rotolo in linea
Rod cm 12, also for in-line roll
Canne cm 12, également pour les rouleaux en ligne
Stange cm 12, auch für Inline-Rolle
Вал см 12, также для линейного рулона
cm 12 L

• 08 - 23	€ 27,00
• 10 - 36	€ 34,00

**RL 039 M**

Porta scopino a parete
Wall mounted toilet-brush
Porte balayent à mur
Bürstengarnitur wandhängend
Настенный металлический ёрш
cm 8 L x 8 P x 60 H

• 08 - 23	€ 145,00
• 10 - 36	€ 185,00

**RAIL 1**

Supporto 1 via destro o sinistro
Support 1 way right or left
Support 1 voie droite ou gauche
Unterstützung 1 Weg rechts oder links
Поддержка 1 путь направо или налево
cm 1,6

• 08 - 23	€ 29,00
• 10 - 36	€ 40,00

**RAIL 2**

Supporto 2 vie
2-way support
Soutien à double sens
2-Wege-Unterstützung
двусторонняя поддержка
cm 1,6

• 08 - 23	€ 29,00
• 10 - 36	€ 40,00

**RL 40**

Mensola cm 40
Shelf
Étagère
Ablage
Полка см 40
cm 40 L x 12 P

• Legno - Ocritech	€ 65,00
• Marmo bianco	€ 130,00

**RL 40.1**

Mensola cm 40 con 1 foro
Shelf with 1 hole
Étagère avec 1 trou
Ablage mit 1 loch
Полка 40 см с 1 отверстием
cm 40 L x 12 P

• Legno - Ocritech	€ 70,00
• Marmo bianco	€ 165,00

**RL 40.2**

Mensola cm 40 con 2 fori
Shelf with 2 hole
Étagère avec 2 trou
Ablage mit 2 loch
Полка 40 см с 2 на 1
cm 40 L x 12 P

• Legno - Ocritech	€ 72,00
• Marmo bianco	€ 165,00

**RL 40.3**

Mensola cm 40 con 1 foro specchio
Shelf with 1 hole for mirror
Étagère avec 1 trou pour miroir
Ablage mit 1 loch für spiegel
Полка 40 см с 1 зеркальным отверстием
cm 40 L x 12 P

• Legno - Ocritech	€ 70,00
• Marmo bianco	€ 155,00

**RAIL 2.T**

Supporto 2 vie a T
T-shaped 2-way support
Support bidirectionnel en forme de T
T-förmige 2-Wege-Stütze
T-образная 2-х сторонняя опора
cm 1,6

• 08 - 23	€ 29,00
• 10 - 36	€ 40,00

**RAIL 3**

Supporto 3 vie
3-way support
Soutien à trois voies
3-Wege-Unterstützung
3-сторонняя поддержка
cm 1,6

• 08 - 23	€ 29,00
• 10 - 36	€ 40,00

**RAIL 4**

Supporto 2 vie ad angolo
2-way corner support
Support d'angle à 2 voies
2-Wege-Eckstütze
Двусторонняя угловая опора
cm 1,6

• 08 - 23	€ 29,00
• 10 - 36	€ 40,00

**RL 60**

Mensola cm 12 porta smartphone
Phone holder shelf
Étagère avec support de téléphone
Ablage telefonhalter
Полка 12 см держатель для смартфона
cm 15 L x 12 P

• Legno - Ocritech	€ 43,00
• Marmo bianco	€ 63,00

**RL 040.08**

Bicchieri in vetro
Glass holder
Porte verre
Zahnbürstenhalter aus Glas
Стеклянный держатель
cm 6 L x 6 P x 11 H

•	€ 28,00
---	---------

**RL 037.08**

Dosatore sapone liquido in vetro con
pompetta metallo
Glass liquid soap dispenser with chrome pump
Doseur de savon liquid en verre avec pompe
Seifenspender aus Glas
Стеклянный дозатор
cm 8 L x 8 P x 13 H

• 08 - 23	€ 74,00
• 10 - 36	€ 84,00



RL 01.70
Specchio rettangolare filo lucido reversibile
Reversible rectangular mirror with shine edge
Miroir rectangulaire avec bord brillant réversible
Rechteckiger Spiegel mit glänzendem Rand
Прямоугольное зеркало с реверсивной полированной проволокой
cm 55 x 70

• € 155,00



RL 01.90
Specchio rettangolare filo lucido reversibile
Reversible rectangular mirror with shine edge
Miroir rectangulaire avec bord brillant réversible
Rechteckiger Spiegel mit glänzendem Rand
Прямоугольное зеркало с реверсивной полированной проволокой
cm 55 x 90

• € 170,00

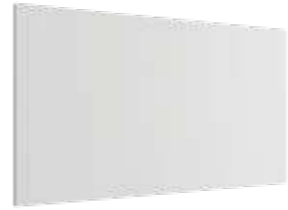

RL 01.120
Specchio rettangolare filo lucido reversibile
Reversible rectangular mirror with shine edge
Miroir rectangulaire avec bord brillant réversible
Rechteckiger Spiegel mit glänzendem Rand
Прямоугольное зеркало с реверсивной полированной проволокой
cm 55 x 120

• € 190,00

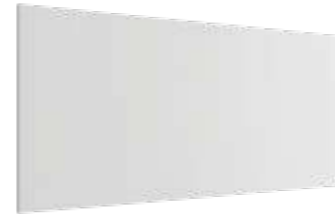

RL 01.140
Specchio rettangolare filo lucido reversibile
Reversible rectangular mirror with shine edge
Miroir rectangulaire avec bord brillant réversible
Rechteckiger Spiegel mit glänzendem Rand
Прямоугольное зеркало с реверсивной полированной проволокой
cm 55 x 140

• € 250,00



RL 03
Applique per specchio a led
Led mirror lamp
Lampe a led pour miroir
LED Leuchte für Spiegel
Настенный светильник для светодиодного зеркала
cm 60 L x 10 P x 4 H
CE : V 220 IP23 LED 7,5W a 12 Vdc 4000K

• 08 - 23 € 248,00
• 10 - 36 € 298,00



RL 488
Specchio ingranditore 3x portatile
Portable 3x magnifying mirror
Miroir grossissant portable 3x
Tragbarer Spiegel mit 3-facher Vergrößerung
Портативное 3-кратное увеличительное зеркало
Cm Ø 20

• 08 - 23 € 125,00
• 10 - 36 € 160,00



RL 28.70
Piano con lavabo integrato in ocritech
Ocritech top with washbasin
Plan en ocritech avec lavabo
Platte mit integriertem Ocritech-Waschbecken
Топ со встроенным умывальником Ocritech
cm 70 L x 50 P

• 01 € 450,00



RL 28.90
Piano con lavabo integrato in ocritech
Ocritech top with washbasin
Plan en ocritech avec lavabo
Platte mit integriertem Ocritech-Waschbecken
Топ со встроенным умывальником Ocritech
cm 90 L x 50 P

• 01 € 550,00



RL 28.120
Piano con lavabo integrato in ocritech
Ocritech top with washbasin
Plan en ocritech avec lavabo
Platte mit integriertem Ocritech-Waschbecken
Топ со встроенным умывальником Ocritech
cm 120 L x 50 P

• 01 € 610,00



RL 29.70
Struttura porta lavabo in ottone
Top brass support
Support en lation for plan
Waschtischhalterung aus Messing
Латунная конструкция держателя умывальника
cm 70 L x 50 P x 83 H

• 08 - 23 € 480,00
• 10 - 36 € 590,00



RL 29.90
Struttura porta lavabo in ottone
Top brass support
Support en lation for plan
Waschtischhalterung aus Messing
Латунная конструкция держателя умывальника
cm 90 L x 50 P x 83 H

• 08 - 23 € 490,00
• 10 - 36 € 620,00



RL 29.120
Struttura porta lavabo in ottone
Top brass support
Support en lation for plan
Waschtischhalterung aus Messing
Латунная конструкция держателя умывальника
cm 120 L x 50 P x 83 H

• 08 - 23 € 560,00
• 10 - 36 € 690,00



OPZIONI E COMPLEMENTI / OPTIONS AND COMPLEMENTS / OPTIONS ET COMPLÉMENTS / OPTIONEN UND ERGÄNZUNGEN / варианты и дополнения

* FINITURA DISPONIBILE IN 20 GG. / Finish available in 20 days / Finition disponible en 20 jours / Oberfläche lieferbar in 20 Tagen / Отделка доступна в течение 20 дней



08



CROMO
Chrome
Chrome
Chrom
хром

10



OTTONE LUCIDO
Polished brass
Laiton poli
Messing poliert
Полированная латунь

23



NERO OPACO
Matt black
Noir opaque
Mattschwarz
черный матовый

36*



NICHEL SATINATO
Satin nickel
Nickel satiné
Nickel satiniert
Никель сатин



FN*

PROGETTO SARTORIA
Tailoring project
Finishes on request
finitions sur demande
Ausführungen auf Anfrage
отделка по запросу

FN*PVD**

PROGETTO SARTORIA PVD+80% DAL 08
Tailoring project PVD
increase +80% on 08
augmentation +80% sur 08
Steigerung +80% auf 08
рный матовый

* FINITURA DISPONIBILE IN 20 GG.
Finish available in 20 days Finition Disponible en 20 jours
Oberfläche lieferbar in 20 Tagen / Отделка доступна в течение 20 дней

** FINITURA DISPONIBILE IN 40 GG.
Finish available in 40 days Finition Disponible en 40 jours
Oberfläche lieferbar in 40 Tagen / Отделка доступна в течение 40 дней

MULTISTRATO MARINO



Marine plywood
Contreplaqué marine
Marinesperrholz
многослойный морской

OCRITECH



Ocritech
Ocritech
Ocritech

MARMO BIANCO



Marble
Marbre
Marmor
Белый мрамор

GUIDA AL CONFIGURATORE RAIL

GUIDE TO RAIL CONFIGURATOR / GUIDE DU CONFIGURATEUR DE RAIL / ANLEITUNG ZU RAIL CONFIGURATOR / РУКОВОДСТВО ПО RAIL CONFIGURATOR

EUROPEAN
PRODUCT
DESIGN
AWARD

stilhaus

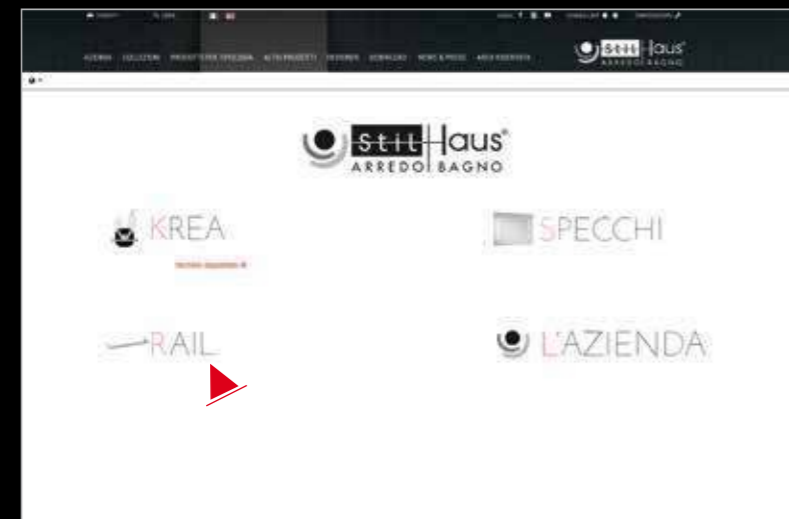

Entra nel configuratore, scegli la proposta e clicca su Rail e segui le richieste.

Enter the configurator, click on rail and you can start creating your own 3d composition starting from an empty wall.

Entrez dans le configurateur, choisissez votre proposition, cliquez sur Rail et suivez les instructions.

Einstieg in den Konfigurator, Wählen Sie Ihren Vorschlag, Klicken Sie auf Rail und folgen Sie den Anweisungen.

Войдите в конфигуратор, Выберите свое предложение, Нажмите на Rail и следуйте требованиям.

Seleziona i componenti.

Select the components on the left side of the screen.

Sélectionnez les composants.

Komponenten auswählen.

Выберите компоненты.

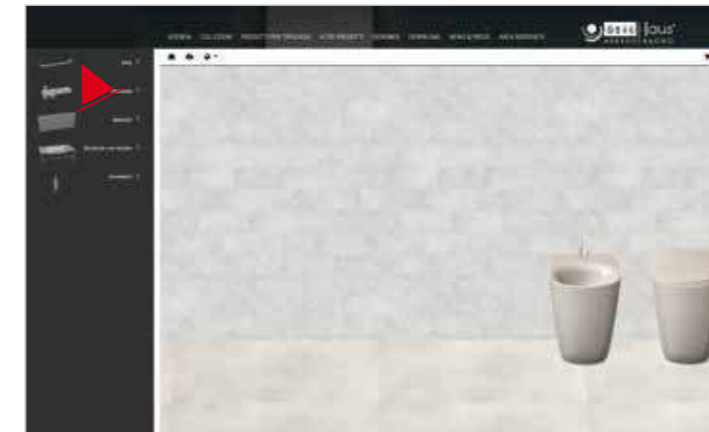

Crea composizioni ruotando le aste.

To design your composition you can rotate every components by the selected button.

Créez des compositions en faisant tourner les tiges.

Erstellen Sie Kompositionen, indem Sie die Stäbe drehen.

Создавайте композиции, вращая стержни.

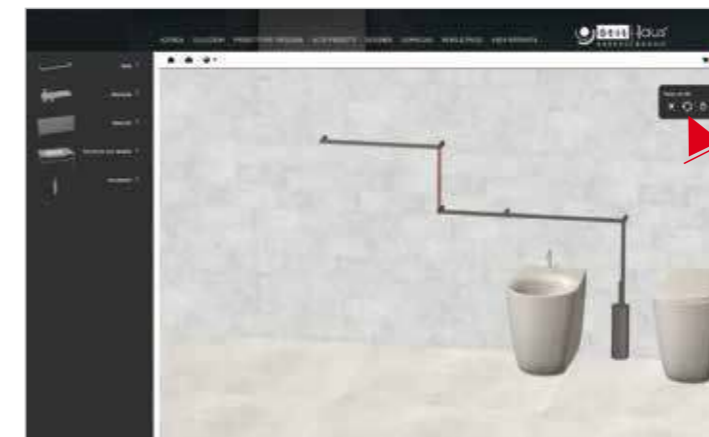

Scegli le finiture.

Choose the best finish you want for your composition.

Choisissez vos finitions.

Wählen Sie Ihre Oberflächen aus.

Выберите отделку.

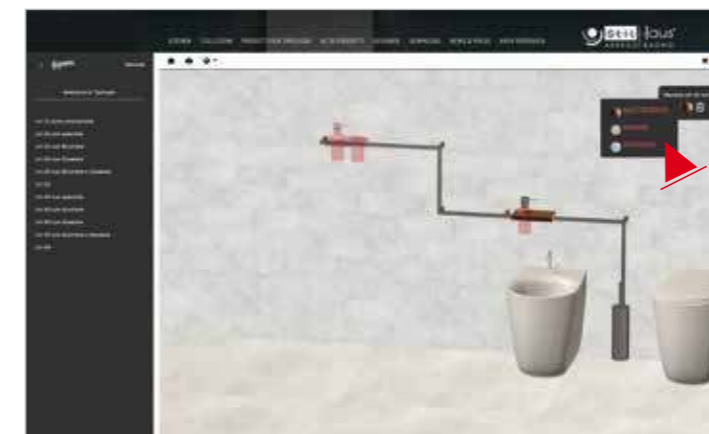

Crea barre continue sovrapponendo gli attacchi.

Place the selected items on the wall, creating your design. you can also overlap

Crée des barres continues en superposant les attaches.

Erzeugt durchgehende Balken durch überlappende Anhänge.

Создает непрерывные полосы путем наложения насадок друг на друга.

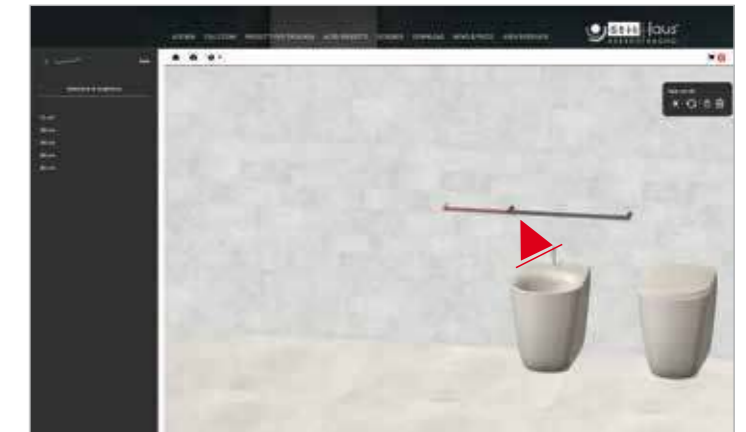

Inserisci le mensole.

Put on the composition the shelves with accessories you need.

Insérer des étagères.

Einlegeböden.

Вставьте полки.

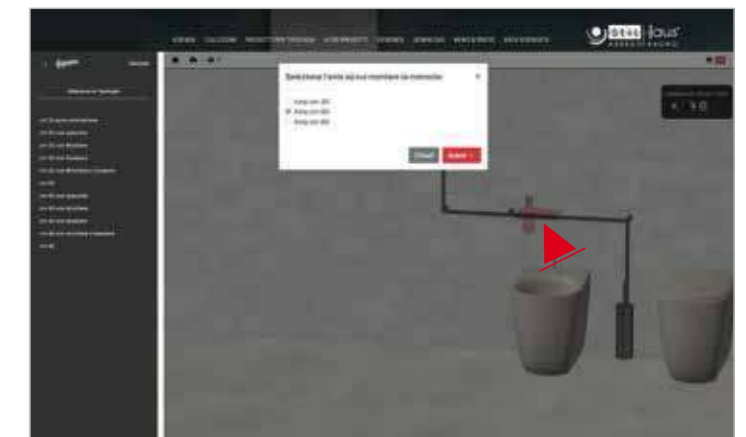

Apri il carrello e procedi all'ordine

Go to the cart and proceed with order or quotation

Ouvrir le panier d'achat et procéder à la commande

Öffnen Sie den Warenkorb und fahren Sie mit der Bestellung fort

Откройте корзину и перейдите к оформлению заказа





MILANO

Designer: Ervas Basilico Girardi

Materiale: ACCIAIO INOX 316
Accessori: Neolite
Finitura: 54 - 23 - 24
Incollo : Si

Material: Stainless Steel 316
Accessories: Neolite
Finish: 54 - 23 - 24
Gluing: Yes

Matériau : Acier inoxydable 316
Accessoires : Néolite
Finition : 54 - 23 - 24
Collage : Oui

Material: Edelstahl 316
Zubehör: Neolite
Finish: 54 - 23 - 24
Verklebung: Ja

Материал: Нержавеющая сталь 316
Аксессуары: Неолит
Отделка: 54 - 23 - 24
Клей: Да

MILANO

MM 06/10 54
MM 1206



MILANO

MM 13/3 23



MM 45 23



MM 11/60 54





MM 05

Asta porta salviette con mensola
Towel rack with shelf
Porte-serviettes avec étagère
Handtuchhalter mit Ablage
Полка для полотенец с полкой
cm 60 L x 11 P x 9 H

• 54	€ 96,00
• 23-24	€ 115,00



MM 45

Asta porta salviette con mensola
Towel rack with shelf
Porte-serviettes avec étagère
Handtuchhalter mit Ablage
Полка для полотенец с полкой
cm 45 L x 11 P x 9 H

• 54	€ 80,00
• 23-24	€ 95,00



MM 06

Asta porta salviette con mensola
Towel rack with shelf
Porte-serviettes avec étagère
Handtuchhalter mit Ablage
Полка для полотенец с полкой
cm 30 L x 11 P x 9 H

• 54	€ 65,00
• 23-24	€ 85,00



MM 05/10

Asta porta salviette con mensola e foro
Towel rack with shelf and hole
Porte-serviettes avec étagère et trou
Handtuchhalter mit Ablage und Loch
Полка для полотенец с полкой и отверстием
cm 60 L x 11 P x 9 H

• 54	€ 96,00
• 23-24	€ 115,00



MM 45/10

Asta porta salviette con mensola e foro
Towel rack with shelf and hole
Porte-serviettes avec étagère et trou
Handtuchhalter mit Ablage und Loch
Полка для полотенец с полкой и отверстием
cm 45 L x 11 P x 9 H

• 54	€ 80,00
• 23-24	€ 95,00



MM 06/10

Asta porta salviette con mensola e foro
Towel rack with shelf and hole
Porte-serviettes avec étagère et trou
Handtuchhalter mit Ablage und Loch
Полка для полотенец с полкой и отверстием
cm 30 L x 11 P x 9 H

• 54	€ 65,00
• 23-24	€ 85,00



MM 1205

Bicchieri in Neolite per Milano
Neolite glass for Milano
Verre de néolite pour Milano
Neolithglas für Milano
Неолитовое стекло для Milano
cm Ø 7,5 x 13 H

• BI	€ 88,00
• NE	€ 99,00



MM 1206

Dosatore in Neolite per Milano
Neolite dispenser for Milano
Distributeur de néolite pour Milano
Neolith-Spender für Milano
Неолитовый дозатор для Milano
cm Ø 7,5 x 17 H

• BI / 54	€ 148,00
• BI / 23/24	€ 162,00
• NE / 54 - 23	€ 158,00
• NE / 23-24	€ 174,00



MM 10/30

Supporto per dosatore / bicchiere
Towel rail
Porte serviettes
Handtuchhalter
Штанга для полотенец
cm 5 L x 25 P x 15 H

• 54	€ 34,00
• 23-24	€ 40,00



MM 11

Porta rotolo a parete
Wall-mounted toilet paper holder
Porte-rouleau mural
Wand-Toilettenpapierhalter
Настенный держатель для туалетной бумаги
cm 16 L x 8,5 P x 5 H

• 54	€ 38,00
• 23-24	€ 44,00



MM 11/60

Porta rotolo a parete con mensola
Wall-mounted toilet paper holder with shelf
Porte-rouleau mural avec étagère
Wand-Toilettenpapierhalter mit Ablage
Настенный держатель для туалетной бумаги с полкой
cm 23 L x 11 P x 5 H

• 54	€ 49,00
• 23-24	€ 65,00



MM 13

Porta accappatoio singolo
Single robe hook
Patère simple
Einzelner Bademantelhaken
Одиночная крючок для халата
cm 6 L x 4 P x 5 H

• 54	€ 24,00
• 23-24	€ 31,00



**MM 13/3**

Porta accappatoio tripla
Triple robe hook
Patère triple
Dreifacher Bademantelhaken
Тройной крючок для халата
cm 32 L x 4 P x 5 H

• 54	€ 38,00
• 23-24	€ 48,00

**MM1335**

Mensola doccia
Shower shelf
Étagère de douche
Duschregal
Полка для душа
cm 60 L x 12 P x 8 H

• 54	€ 180,00
• 23-24	€ 200,00

**MM 1336**

Traversa per vasca
Bath rail
Traverse de baignoire
Badewannengriff
Перила для ванны
cm 80 L x 15 P x 15 H

• 54	€ 150,00
• 23-24	€ 170,00

**MM 1337**

Angolo doccia 2 ganci
Shower corner with 2 hooks
Coin de douche avec 2 crochets
Duschecke mit 2 Haken
Душевой уголок с 2 крючками
cm 29 L x 20 P x 9 H

• 54	€ 95,00
• 23-24	€ 120,00

**MM 20 M**

Porta rotolo e porta scopino a parete
Wall-mounted toilet paper holder and brush holder
Porte-rouleau de papier toilette et porte-brosse mural
Wand-Toilettenpapierhalter und Bürstenhalter
Настенный держатель для туалетной бумаги и держатель для щётки
cm 24 L x 8 P x 38 H

• 54	€ 170,00
• 23-24	€ 185,00

**MM 20 MT**

Porta rotolo e porta scopino a parete con mensola
Wall-mounted toilet paper holder and brush holder with shelf
Porte-rouleau de papier toilette et porte-brosse mural avec étagère
Wand-Toilettenpapierhalter und Bürstenhalter mit Ablage
Настенный держатель для туалетной бумаги и держатель для щётки с полкой
cm 24 L x 11 P x 46 H

• 54	€ 185,00
• 23-24	€ 210,00

**MM 039**

Porta scopino da appoggio
Freestanding brush holder
Porte-brosse sur pied
Freistehender Bürstenhalter
Подставка для щётки
cm 8 Ø x 40 H

• 54	€ 85,00
• 23-24	€ 94,00

**MM 039 M**

Porta scopino a parete
Wall-mounted brush holder
Porte-balayette murale
Wandbürstenhalter
Настенный держатель для щеток
cm 8 Ø x 40 H

• 54	€ 98,00
• 23-24	€ 108,00

**840**

Kit collante e biadesivo per un articolo
Kit with bi-adhesive and glue for one article
Kit avec collant et biadhésif pour un article
Klebekit ist ein beidseitiger Klebestreifen
Клей

•	€ 4,80
---	--------

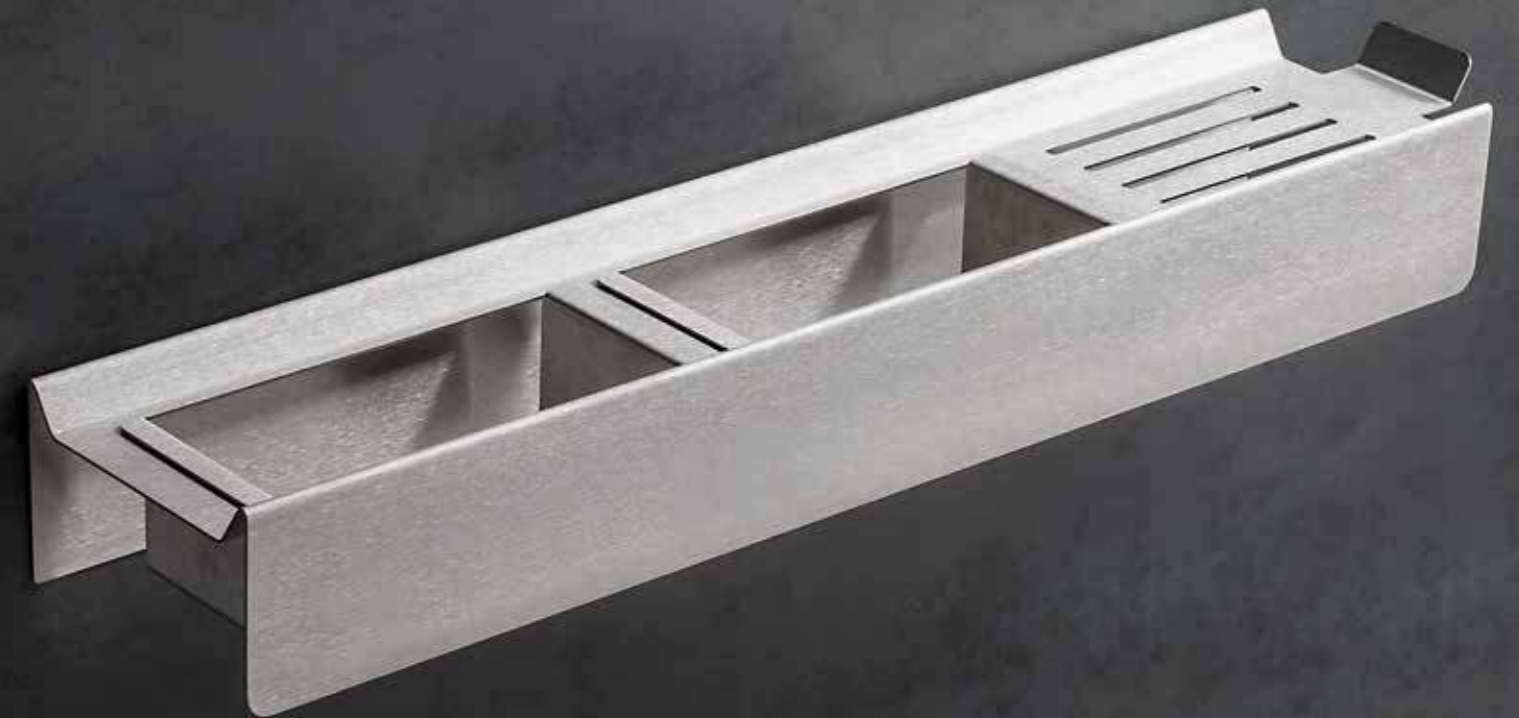
**OPZIONI E COMPLEMENTI / OPTIONS AND COMPLEMENTS / OPTIONS ET COMPLÉMENTS / OPTIONEN UND ERGÄNZUNGEN / варианты и дополнения****54**

ACCIAIO INOX SATINATO
satin stainless steel
Acier inoxydable satiné
Edelstahl satiniert
сатинированная
нержавеющая сталь

23

NERO OPACO
Matt black
Noir opaque
Mattschwarz
черный матовый

24

BIANCO OPACO
Matt white
Blanc opaque
Weiße
белый матовый



EQUILIBRIUM

Designer: GIANLUCA PALUDI

Materiale: Marmo - Resina - Ottone
Accessori: Marmo - Resina
Finiture: 08 - 18 - 23 - 36
Fuori misura: No

Material: Marble - Resin - Brass
Accessories: Marble - Resin
Finishes: 08 - 18 - 23 - 36
Customized: No

Matière: Marbre - Résine - Laiton
Accessoires: Marbre - Résine
Finitions: 08 - 18 - 23 - 36
Personnalisé: Non

Material: Marmor - Kunstharz - Messing
Zubehör: Marmor - Harz
Ausführungen: 08 - 18 - 23 - 36
Kundenwunsch: No

Материал: Мрамор - Смола - Латунь
Аксессуары: Мрамор - Смола
Отделка: 08 - 18 - 23 - 36
Негабаритный: No

EQUILIBRIUM marmo e ottone

EQM 05 18



EQUILIBRIUM brass and marble

EQM 06/11 SX 36



EQM 11 08



EQM 13 23



EQR 05 23



EQR 06/11 SX 18



EQR 13 08



EQRNO06 SX 08



EQUILIBRIUM ottone

EQO 05 36



EQUILIBRIUM brass

EQO 06 SX



EQOB 11 11



EQOC 13 08



EQDA 05 36



EQDC 30 AP 11
EQDC 10 AP 11

EQDB 11 11



EQDC 13 08





EQM 05

Asta porta salviette
Towel rail
Porte serviettes
Handtuchhalter
Полотенцедержатель
cm 50 L x 7 P x 5 H

• 08 - 23	€ 250,00
• 18 - 36	€ 290,00
• FN	€ 310,00



EQM 06 DX

Asta porta salviette
Towel rail
Porte serviettes
Handtuchhalter
Полотенцедержатель
cm 35 L x 7 P x 5 H

• 08 - 23	€ 230,00
• 18 - 36	€ 270,00
• FN	€ 290,00



EQM 06 SX

Asta porta salviette
Towel rail
Porte serviettes
Handtuchhalter
Полотенцедержатель
cm 35 L x 7 P x 5 H

• 08 - 23	€ 230,00
• 18 - 36	€ 270,00
• FN	€ 290,00



EQM 06 / 11 DX

Porta salviette con porta rotolo destro
Towel rail with right-hand roll holder
Porte-serviettes avec support de rouleau sur le côté droit
Handtuchhalter mit rechtsseitigem Rollenhalter
Держатель полотенец с правосторонним держателем рулона
cm 45 L x 7 P x 5 H

• 08 - 23	€ 250,00
• 18 - 36	€ 290,00
• FN	€ 310,00



EQM 06 / 11 SX

Porta salviette con porta rotolo sinistro
Towel rail with left-hand roll holder
Porte-serviettes avec porte-rouleau à gauche
Handtuchhalter mit Rollenhalter links
Полотенцесушитель с левосторонним держателем рулона
cm 45 L x 7 P x 5 H

• 08 - 23	€ 250,00
• 18 - 36	€ 290,00
• FN	€ 310,00



EQM 10 AP

Bicchieri in Marmo
Marble glass
Verre marbré
Marmoriertes Glas
Мраморное стекло
cm Ø 7,5 x 13 H

•	€ 240,00
---	----------



EQM 30 AP

Dosatore sapone liquido in Marmo
Marble liquid soap dispenser
Distributeur de savon liquide en marbre
Flüssigseifenspender aus Marmor
Мраморный дозатор для жидкого мыла
cm Ø 7,5 x 17 H

• 08 - 23	€ 310,00
• 18 - 36	€ 345,00
• FN	€ 365,00



EQM 11

Porta rotolo
Paper holder
Porte rouleau
Papierrollenhalter
Бумагодержатель
cm 21 L x 7 P x 5 H

• 08 - 23	€ 220,00
• 18 - 36	€ 260,00
• FN	€ 280,00



EQM 13

Porta accappatoio (2 ganci)
Robe hook (2 hooks)
Porte peignoir (2 crochets)
Bademantelhaken
Крючок двойной
cm 13 L x 7 P x 5 H

• 08 - 23	€ 220,00
• 18 - 36	€ 260,00
• FN	€ 280,00



EQM 12 AP

Porta scopino da appoggio
Toilet-brush with base
Porte balaynet d'appui
Bürstengarnitur freistehend
Напольный металлический ёрш
cm Ø 12 x 45 H

• 08 - 23	€ 290,00
• 18 - 36	€ 345,00
• FN	€ 365,00



EQM 13 18

OPZIONI E COMPLEMENTI / OPTIONS AND COMPLEMENTS / OPTIONS ET COMPLÉMENTS / OPTIONEN UND ERGÄNZUNGEN / варианты и дополнения



08

CROMO
Chrome
Chrome
Chrom
хром



18

ORO OPACO
Matt gold
Or opaque
Opak gold
Золото



23

NERO OPACO
Matt black
Noir opaque
Mattschwarz
черный матовый



36

NICHEL SATINATO
Satin nickel
Nickel satiné
Nickel satiniert
Никель сатин



FN*

PROGETTO SARTORIA
Tailoring project
Finishes on request
finitions sur demande
Ausführungen auf Anfrage
отделка по запросу



FN PVD**

PROGETTO SARTORIA PVD+80% DAL 08
Tailoring project PVD
increase +80% on 08
augmentation +80% sur 08
Steigerung +80 % auf 08
рный матовый

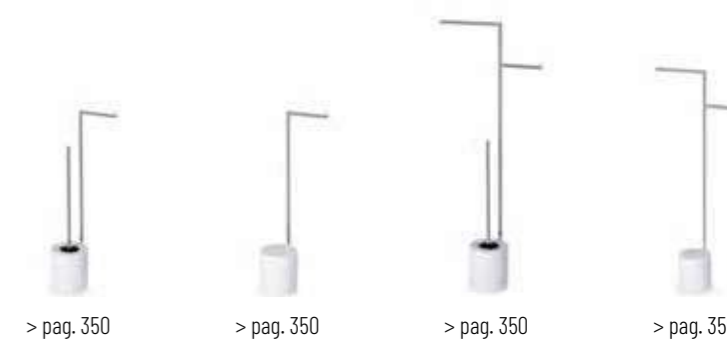

> pag. 350

> pag. 350

> pag. 350

> pag. 350



EQR 05
Asta porta salviette
Towel rail
Porte serviettes
Handtuchhalter
Полотенцедержатель
cm 50 L x 7 P x 5 H

• 08 - 23	€ 120,00
• 18 - 36	€ 145,00
• FN	€ 165,00



EQR 06 DX
Asta porta salviette
Towel rail
Porte serviettes
Handtuchhalter
Полотенцедержатель
cm 32,5 L x 7 P x 5 H

• 08 - 23	€ 105,00
• 18 - 36	€ 130,00
• FN	€ 150,00



EQR 06 SX
Asta porta salviette
Towel rail
Porte serviettes
Handtuchhalter
Полотенцедержатель
cm 32,5 L x 7 P x 5 H

• 08 - 23	€ 105,00
• 18 - 36	€ 130,00
• FN	€ 150,00



EQR 06 / 11 DX
Porta salviette con porta rotolo destro
Towel rail with right-hand roll holder
Porte-serviettes avec support de rouleau sur le côté droit
Handtuchhalter mit rechtsseitigem Rollenhalter
Держатель полотенец с правосторонним держателем рулона
cm 45 L x 7 P x 5 H

• 08 - 23	€ 120,00
• 18 - 36	€ 145,00
• FN	€ 165,00



EQR 06 / 11 SX
Porta salviette con porta rotolo sinistro
Towel rail with left-hand roll holder
Porte-serviettes avec porte-rouleau à gauche
Handtuchhalter mit Rollenhalter links
Полотенцесушитель с левосторонним держателем рулона
cm 45 L x 7 P x 5 H

• 08 - 23	€ 120,00
• 18 - 36	€ 145,00
• FN	€ 165,00



1204
Porta sapone in Neolite
Neolite soap dish
Porte-savon en néolite
Seifenschale aus Neolith
Неолитовая мыльница
cm - Ø 12 x 3 H

• BI	€ 65,00
• NE	€ 75,00



1205
Bicchieri in Neolite
Neolite glass
Verre de néolite
Neolith-Glas
Неолитовое стекло
cm - Ø 7,5 x 13 H

• BI	€ 75,00
• NE	€ 85,00



1206
Dosatore sapone liquido in Neolite
Marble liquid soap dispenser
Distributeur de savon liquide en marbre
Flüssigseifenspender aus Marmor
Мраморный дозатор для жидкого мыла
cm - Ø 7,5 x 17 H

• BI / 08 - 23	€ 135,00
• BI / 18 - 36	€ 165,00
• BI / FN	€ 195,00
• NE / 08 - 23	€ 150,00
• NE / 18 - 36	€ 175,00
• NE / FN	€ 195,00



EQR 11
Porta rotolo
Paper holder
Porte rouleau
Papierrollenhalter
Бумагодержатель
cm 21 L x 7 P x 5 H

• 08 - 23	€ 90,00
• 18 - 36	€ 115,00
• FN	€ 135,00



EQR 13
Porta accappatoio (2 ganci)
Robe hook (2 hooks)
Porte peignoir (2 crochets)
Bademantelhaken
Крючок двойной
cm 13 L x 7 P x 5 H

• 08 - 23	€ 90,00
• 18 - 36	€ 115,00
• FN	€ 135,00



EQR 12 AP
Porta scopino da appoggio
Toilet-brush with base
Porte balaynet d'appui
Bürstengarnitur freistehend
Напольный металлический ёрш
cm Ø 15 x 40 H

• 08 - 23	€ 170,00
• 18 - 36	€ 200,00
• FN	€ 220,00



EQR 06 79

OPZIONI E COMPLEMENTI / OPTIONS AND COMPLEMENTS / OPTIONS ET COMPLÉMENTS / OPTIONEN UND ERGÄNZUNGEN / варианты и дополнения



08



CROMO
Chrome
Chrome
Chrom
хром

18



ORO OPACO
Matt gold
Or opaque
Opak gold
Золото

23



NERO OPACO
Matt black
Noir opaque
Mattschwarz
черный матовый

36



NICHEL SATINATO
Satin nickel
Nickel satiné
Nickel satiniert
Никель сатин

NEOP



RESINA NERO OPACO
Matt black resin
Résine Noir mat
Mattschwarz Harz
черная матовая смола

Disponibili in neolite opaco (maggiorazione)
Available in matt neolite (supplement)
Disponibile en néolite mat (supplément)
Erhältlich in mattem Neolith (Zuschlag)
Доступен в матовом неолитовом цвете
(дополнительно)

•	€ 10,00
---	---------



FN*

PROGETTO SARTORIA
Tailoring project
Finishes on request
finitions sur demande
Ausführungen auf Anfrage
отделка по запросу

FN PVD**

PROGETTO SARTORIA PVD+80% DAL 08
Tailoring project PVD
increase +80% on 08
augmentation +80% sur 08
Steigerung +80 % auf 08
рный матовый



EQO 05

Asta porta salviette
Towel rail
Porte serviettes
Handtuchhalter
Полотенцедержатель
cm 50 L x 7 P x 5 H

• 08 - 23	€ 98,00
• 18 - 36	€ 140,00
• FN	€ 155,00



EQO 06 DX

Asta porta salviette
Towel rail
Porte serviettes
Handtuchhalter
Полотенцедержатель
cm 35 L x 7 P x 5 H

• 08 - 23	€ 89,00
• 18 - 36	€ 125,00
• FN	€ 140,00



EQO 06 SX

Asta porta salviette
Towel rail
Porte serviettes
Handtuchhalter
Полотенцедержатель
cm 35 L x 7 P x 5 H

• 08 - 23	€ 89,00
• 18 - 36	€ 125,00
• FN	€ 140,00



EQO 06 / 11 DX

Porta salviette con porta rotolo destro
Towel rail with right-hand roll holder
Porte-serviettes avec support de rouleau sur le côté droit
Handtuchhalter mit rechtsseitigem Rollenhalter
Держатель полотенец с правосторонним держателем рулона
cm 45 L x 7 P x 5 H x

• 08 - 23	€ 98,00
• 18 - 36	€ 140,00
• FN	€ 155,00



EQO 06 / 11 SX

Porta salviette con porta rotolo sinistro
Towel rail with left-hand roll holder
Porte-serviettes avec porte-rouleau à gauche
Handtuchhalter mit Rollenhalter links
Полотенцесушитель с левосторонним держателем рулона
cm 45 L x 7 P x 5 H

• 08 - 23	€ 98,00
• 18 - 36	€ 140,00
• FN	€ 155,00



EQO 11

Porta rotolo
Paper holder
Porte rouleau
Papierrollenhalter
Бумагодержатель
cm 21 L x 7 P x 5 H

• 08 - 23	€ 79,00
• 18 - 36	€ 120,00
• FN	€ 135,00



HS 10 AP

Bicchieri da appoggio
Glass with base
Verre d'appui
Zahnputzbecher freistehend
Настольный металлический стакан
cm Ø 6,5 x 11,5 H

• 08 - 23	€ 50,00
• 18 - 36	€ 84,00
• FN	€ 90,00



HS 30 AP

Dosatore sapone d'appoggio
Soap dispenser with base
Porte savon d'appui
Seifenspender freistehend
Настольный металлический дозатор
cm Ø 6,5 x 18 H

• 08 - 23	€ 90,00
• 18 - 36	€ 135,00
• FN	€ 155,00



EQO 13

Porta accappatoio (2 ganci)
Robe hook (2 hooks)
Porte peignoir (2 crochets)
Bademantelhaken
Крючок двойной
cm 13 L x 7 P x 5 H

• 08 - 23	€ 79,00
• 18 - 36	€ 120,00
• FN	€ 135,00



1946

Porta scopino a parete
Wall-mounted toilet-brush
Porte balayent à mur
Bürstengarnitur oval wandhängend
Настенный металлический ёрш
cm Ø 6,5 x 40H

• 08 - 23	€ 72,00
• 18 - 36	€ 105,00
• FN	€ 115,00



1946 AP

Porta scopino da appoggio
Toilet-brush with base
Porte balayent d'appui
Bürstengarnitur freistehend
Напольный металлический ёрш
cm Ø 6,5 x 40H

• 08 - 23	€ 72,00
• 18 - 36	€ 105,00
• FN	€ 115,00



840

Kit collante e biadesivo per un articolo
Kit with bi-adhesive and glue for one article
Kit avec collant et biadhésif pour un article
Klebekit ist ein beidseitiger Klebestreifen
Клей

•	€ 4,80
---	--------



EQO 11 18

OPZIONI E COMPLEMENTI / OPTIONS AND COMPLEMENTS / OPTIONS ET COMPLÉMENTS / OPTIONEN UND ERGÄNZUNGEN / варианты и дополнения



08

CROMO
Chrome
Chrome
хром



18

ORO OPACO
Matt gold
Or opaque
Opak gold
Золото



23

NERO OPACO
Matt black
Noir opaque
Mattschwarz
черный матовый



36

NICHEL SATINATO
Satin nickel
Nickel satiné
Nickel satiniert
Никель сатин



FN*

PROGETTO SARTORIA
Tailoring project
Finishes on request
finitions sur demande
Ausführungen auf Anfrage
отделка по запросу



FN**

PROGETTO SARTORIA PVD+80% DAL 08
Tailoring project PVD
increase +80% on 08
augmentation +80% sur 08
Steigerung +80 % auf 08
рный матовый



> pag. 354



> pag. 354



> pag. 354



> pag. 354





EQD 05

Asta porta salviette
Towel rail
Porte serviettes
Handtuchhalter
Полотенцедержатель
cm 50 L x 7 P x 5 H

• DA - DB - 08 - 23	€ 110,00
• DA - DB - FN	€ 160,00
• DC - 08 - 23	€ 150,00
• DC - FN	€ 220,00



EQD 06 DX

Asta porta salviette
Towel rail
Porte serviettes
Handtuchhalter
Полотенцедержатель
cm 35 L x 7 P x 5 H

• DA - DB - 08 - 23	€ 90,00
• DA - DB - FN	€ 130,00
• DC - 08 - 23	€ 130,00
• DC - FN	€ 190,00



EQD 06 SX

Asta porta salviette
Towel rail
Porte serviettes
Handtuchhalter
Полотенцедержатель
cm 35 L x 7 P x 5 H

• DA - DB - 08 - 23	€ 90,00
• DA - DB - FN	€ 130,00
• DC - 08 - 23	€ 130,00
• DC - FN	€ 190,00



EQD 06 / 11 DX

Porta salviette con porta rotolo destro
Towel rail with right-hand roll holder
Porte-serviettes avec support de rouleau sur le côté droit
Handtuchhalter mit rechtsseitigem Rollenhalter
Держатель полотенец с правосторонним держателем рулона
cm 45 L x 7 P x 5 H x

• DA - DB - 08 - 23	€ 105,00
• DA - DB - FN	€ 150,00
• DC - 08 - 23	€ 145,00
• DC - FN	€ 210,00



EQD 06 / 11 SX

Porta salviette con porta rotolo sinistro
Towel rail with left-hand roll holder
Porte-serviettes avec porte-rouleau à gauche
Handtuchhalter mit Rollenhalter links
Полотенцесушитель с левосторонним держателем рулона
cm 45 L x 7 P x 5 H

• DA - DB - 08 - 23	€ 105,00
• DA - DB - FN	€ 150,00
• DC - 08 - 23	€ 145,00
• DC - FN	€ 210,00



EQD 10 AP

Bicchiera da appoggio
Glass with base
Verre d'appui
Zahnputzbecher freistehend
Настольный металлический стакан
cm Ø 6,5 x 11,5 H

• DA - DB - 08 - 23	€ 85,00
• DA - DB - FN	€ 120,00
• DC - 08 - 23	€ 135,00
• DC - FN	€ 190,00



EQD 30 AP

Dosatore sapone d'appoggio
Soap dispenser with base
Porte savon d'appui
Seifenspender freistehend
Настольный металлический дозатор
cm Ø 6,5 x 18 H

• DA - DB - 08 - 23	€ 120,00
• DA - DB - FN	€ 165,00
• DC - 08 - 23	€ 170,00
• DC - FN	€ 230,00



EQD 11

Porta rotolo
Paper holder
Porte rouleau
Papierrollenhalter
Бумагодержатель
cm 21 L x 7 P x 5 H

• DA - DB - 08 - 23	€ 84,00
• DA - DB - FN	€ 120,00
• DC - 08 - 23	€ 125,00
• DC - FN	€ 180,00



EQD 13

Porta accappatoio (2 ganci)
Robe hook (2 hooks)
Porte pegnoir (2 crochets)
Bademantelhaken
Бумагодержатель
cm 13 L x 7 P x 5 H

• DA - DB - 08 - 23	€ 84,00
• DA - DB - FN	€ 120,00
• DC - 08 - 23	€ 125,00
• DC - FN	€ 180,00



EQD 1946

Porta scopino a parete
Wall-mounted toilet-brush
Porte balaynet à mur
Bürstengarnitur oval wandhängend
Настенный металлический ёрш
cm Ø 6,5 x 40H

• DA - DB - 08 - 23	€ 105,00
• DA - DB - FN	€ 150,00
• DC - 08 - 23	€ 190,00
• DC - FN	€ 250,00



840

Kit collante e biadesivo per un articolo
Kit with bi-adhesive and glue for one article
Kit avec collant et biadhésif pour un article
Klebekit ist ein beidseitiger Klebestreifen
Клей

•	€ 4,80
---	--------

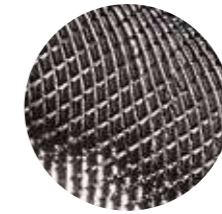

DA - DIAMANTE/DIAMOND

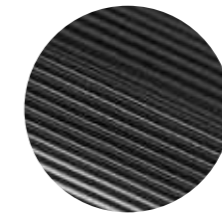

DB - GESSATO/PINSTRIFE



DC - RIGATO/STRIPE

OPZIONI E COMPLEMENTI / OPTIONS AND COMPLEMENTS / OPTIONS ET COMPLÉMENTS / OPTIONEN UND ERGÄNZUNGEN / варианты и дополнения



08

CROMO
Chrome
Chrome
Chrom
хром



23

NERO OPACO
Matt black
Noir opaque
Mattschwarz
черный матовый



FN*

PROGETTO SARTORIA
Tailoring project
Finishes on request
finitions sur demande
Ausführungen auf Anfrage
отделка по запросу

FN*PVD**

PROGETTO SARTORIA PVD
Tailoring project PVD
increase +80% on 08
augmentation +80% sur 08
Steigerung +80 % auf 08
рный матовый



1285

Specchio retroilluminato con punti led
Backlit mirror with LED dots
Miroir rétro-éclairé avec points LED
Hintergrundbeleuchteter Spiegel mit LED-Punkten
Зеркало с подсветкой и светодиодными точками
cm Ø 80

CE: LED - 15 W - V220 - IP21

€ 590,00

1286

Struttura porta lavabo con porta asciugamani
Support with towelholder
Structure avec porte serviette
Struktur mit Handtuchhalter
Структура с полотенцем

1286 cm 50 L x 40 P x 74 H

• 08 - 23 € 460,00
• 18 - 36 € 620,00

1286/60 cm 60 L x 40 P x 74 H

• 08 - 23 € 480,00
• 18 - 36 € 640,00

1282

Lavabo in ceramica
Ceramic washbasin
Lavabo en céramique
Keramik Aufsatzwaschbecken
Керамическая раковина

1282 cm 50 L x 41 P x 16 H

• 01 € 400,00

1282/60 cm 60 L x 41 P x 16 H

• 01 € 440,00

RAC 393

Sifone tornito in ottone 1" ¼
Brass si phon 1" ¼
Siphon en laiton 1" ¼
Siphon aus Messing 1" ¼
Хромированный 1" ¼

• 08 € 86,00
• 16 - 25 - 26 € 230,00



1118

Specchio con LED perimetrale
Mirror with diffused led light
Miroir avec led lumière diffusée
Spiegel mit LED Hinterleuchtung
Зеркало со светодиодом по периметру
cm Ø 70

CE: Led 26 W - V 220 - IP21

€ 320,00

1245 SP

Applique LED per specchio
LED wall light for mirror
Applique LED pour miroir
LED-Wandleuchte für Spiegel
Светодиодный настенный светильник для зеркала
cm 10 L x 15 P x 5 H

CE: V 220/12v IP44 69 3W 3000K

€ 130,00

1092

Specchio ingranditore 3x tondo a parete
Wall mounted round enlarging mirror 3x
Miroir agrandisseur 3x round à mur
Runde Wandspiegel mit Vergrößerung 3x
Настенное косметическое зеркало с 3-х
кратным увеличением

cm Ø 20 x 8/18 P • Base Ø 5 x 1 H

• 08 - 23 € 115,00

812

Vasca di vetro con ghiera di fissaggio
Glass washbasin with fixing ring
Lavabo en verre avec anneau de fixation
Glas Aufsatzwaschbecken rund mit Distanzring
Стекло раковина матовая

cm 37 Ø x 17 H

• Satinato/satin/satin/satinier/Hrom € 310,00

813

Supporto in acciaio con foro rubinetteria
Stainless steel wall bearing with hole for tap
Support en acier inox avec trou pour robinet
Wandhalterung aus Edelstahl für Glaswasch-
becken mit Loch
Настенный фиксатор для сифона

cm 32 P x 10 L x 10 H fori Ø 4,5/3,2

€ 145,00

RAC 488

Piletta di scarico lavabo Up&Down 1" ¼
Washbasin drain Up&Down 1" ¼
Vidage Up&Down pour lavabo 1" ¼
Ablaufventil Up&Down 1" ¼
Дренажного отверстия умывальник вверх и вниз 1" ¼

cm 6 H

€ 48,00

RAC 393

Sifone tornito in ottone 1" ¼
Brass si phon 1" ¼
Siphon en laiton 1" ¼
Siphon aus Messing 1" ¼
Хромированный 1" ¼

€ 86,00



GEA

Designer: STILHAUS

Materiale: Barra ottone pieno 30x20
Accessori: Ceramica bianca
Finiture: 08 - 18 - 61
Fuori misura: Si

Material: Solid brass bar 30x20
Accessories: White ceramic
Finishes: 08 - 18 - 61
Customized: Yes

Matériel: Laiton massif bar 30x20
Accessoires: Blanc céramique
Finitions: 08 - 18 - 61
Personnalisé: Oui

Material: Aus massivem messing bar 30x20
Zubehör: Weiße keramik
Ausführungen: 08 - 18 - 61
Kundenwunsch: Ja

Материал: латунь
Аксессуары: белая керамика
Отделка: 08 - 18 - 61
Негабаритный: да

GEA

GE 69 61



GEA

GE 11 08
GE 12 08



GE 16 08





GE 04

Mensola 8 mm
Shelf
Etagère
Ablage
Стеклянная полка - толщина стекла 8 mm
cm 60 L x 13 P x 2 H x 50 INT

• 08	€ 95,00
• 18 - 61	€ 120,00



GE 05

Asta porta asciugamani
Towel rail
Porte serviettes
Handtuchhalter
полотенцедержатель
cm 56 L x 8 P x 2 H x 49 INT

• 08	€ 175,00
• 18 - 61	€ 220,00



GE 45

Asta porta asciugamani
Towel rail
Porte serviettes
Handtuchhalter
полотенцедержатель
cm 45 L x 8 P x 2 H x 38 INT

• 08	€ 165,00
• 18 - 61	€ 210,00



GE 06

Asta porta salviette
Towel rail
Porte serviettes
Handtuchhalter
Полотенцедержатель
cm 30 L x 8 P x 2 H x 23 INT

• 08	€ 155,00
• 18 - 61	€ 200,00



GE 69

Asta cm 45 con porta sapone DX
Towel rail with soap dish
Porte serviettes avec porte savon
Handtuchhalter mit Seifenschale
Полотенцедержатель +
керамическая мыльница
cm 47,5 L x 9 P x 5 H x 38 INT

• 08	€ 195,00
• 18 - 61	€ 245,00



GE 69 D

Asta cm 45 con dosatore di sapone DX
Towel rail with liquid soap dispenser
Porte serviettes avec dosator de savon
Handtuchhalter mit Seifenspender
Полотенцедержатель +
керамический дозатор
cm 46 L x 8 P x 22 H x 38 INT

• 08	€ 275,00
• 08 A	€ 230,00
• 18 A - 61 A	€ 295,00



GE 16

Porta asciugamani a snodo 2 aste
Towel rail with 2 adjustable bar
Porte serviettes à 2 barres orientables
Handtuchhalter schwenkbar 2 Stangen
Полотенцедержатель двойной
поворотный
cm 31 L x 3,5 P x 5 H

• 08	€ 189,00
• 18 - 61	€ 235,00



GE 07

Anello porta salviette
Serviette holder to ring shaped
Porte serviettes à anneau
Handtuchring
Полотенцедержатель - полукольцо
cm 25 L x 8 P x 12 H

• 08	€ 130,00
• 18 - 61	€ 169,00



GE 79

Anello porta salviette con sapone
Serviette holder with soap
Porte serviettes à anneau avec savon
Handtuchhalter + Seifenschale wandhängend
Полотенцедержатель - полукольцо +
керамическая мыльница
cm 25 L x 9 P x 14 H

• 08	€ 165,00
• 18 - 61	€ 210,00

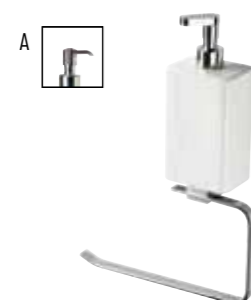

GE 79 D

Anello porta salviette con dosatore sapone
Serviette holder with soap dispenser
Porte serviettes à anneau avec doseur de savon
Handtuchhalter + Seifenspender wandhängend
Полотенцедержатель - полукольцо +
керамический дозатор
cm 25 L x 8 P x 31 H

• 08	€ 260,00
• 08 A	€ 210,00
• 18 A - 61 A	€ 275,00



GE 09

Porta sapone a parete
Wall ceramic soap dish
Porte savon en céramique
Seifenschale wandhängend
Настенная керамическая мыльница
cm 12 L x 9 P x 5 H

• 08	€ 95,00
• 18 - 61	€ 120,00



GE 10

Porta bicchiere a parete
Wall tooth brush holder
Porte verre en céramique
Zahnbürstenhalter wandhängend
Настенный керамический стакан
cm 9 L x 8 P x 16 H

• 08	€ 105,00
• 18 - 61	€ 140,00





GE 30

Dosatore sapone a parete
Wall liquid soap dispenser holder
Doseur de savon liquid en céramique
Seifenspender
Настенный керамический дозатор
cm 9 L x 8 P x 22 H

• 08	€ 130,00
• 08 A	€ 115,00
• 18 A - 61 A	€ 140,00



GE 30 AP

Dosatore sapone liquido d'appoggio
Ceramic liquid soap dispenser
Porte savon liquid en céramique
Seifenspender
Настольный керамический дозатор
cm 9 L x 6,9 P x 19 H

• 08	€ 75,00
• 08 A	€ 58,00
• 18 A - 61 A	€ 68,00



GE 13

Porta accappatoio
Robe hook
Porte peignoir
Bademantelhaken
Крючок
cm 2 L x 3 P x 3 H

• 08	€ 55,00
• 18 - 61	€ 69,00



GE 09 AP

Porta sapone d'appoggio
Soap dish
Porte savon
Seifenschale
Настольная керамическая мыльница
cm 12 L x 8 P x 2 H

• 08	€ 22,00
------	---------



GE 10 AP

Bicchieri d'appoggio
Ceramic glass
Verre en céramique d'appui
Zahnputzbecher
Настольный керамический стакан
cm 9 L x 7 P x 13 H

• 08	€ 26,00
------	---------



GE 13.2

Porta accappatoio (2 ganci)
Robe hook (2 hooks)
Porte peignoir (2 crochets)
Bademantelhaken
Крючок двойной
cm 10 L x 8 P x 2 H

• 08	€ 82,00
• 18 - 61	€ 115,00



GE 11 C

Porta rotolo con coperchio
Covered paper holder
Porte rouleau avec couvercle
Papierrollenhalter mit Deckel
Бумагодержатель с крышкой
cm 13 L x 13 P x 10 H

• 08	€ 130,00
• 18 - 61	€ 160,00

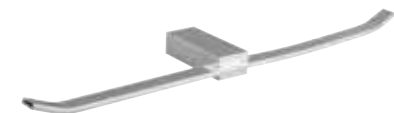

GE 11.2

Porta rotolo doppio
Double paper holder
Porte rouleau double
Papierrollenhalter doppelt
Бумагодержатель двойной
cm 30 L x 8 P x 2 H

• 08	€ 110,00
• 18 - 61	€ 135,00



GE 11 S

Porta rotolo scorta
Paper holder of supply
Porte rouleau s'escorté
Ersatzpapierrollenhalter
Бумагодержатель вертикальный
cm 3 L x 8 P x 18 H

• 08	€ 80,00
• 18 - 61	€ 105,00



GE 12 A

Porta scopino d'appoggio in ceramica
Ceramic toilet brush
Porte balaynet en ceramique
Bürstengarnitur freistehend aus Keramik
Напольный керамический ёрш
cm 10 L x 10 P x 42 H

• 08	€ 96,00
• 18 - 61	€ 140,00



GE 039 M

Porta scopino a parete
Wall ceramic toilet brush
Porte balaynet à mur
Bürstengarnitur wandhängend
Настенный металлический ёрш
cm 8 L x 8 P x 43 H

• 08	€ 195,00
• 18 - 61	€ 250,00

OPZIONI E COMPLEMENTI / OPTIONS AND COMPLEMENTS / OPTIONS ET COMPLÉMENTS / OPTIONEN UND ERGÄNZUNGEN / варианты и дополнения



08

CROMO
Chrome
Chrom
хром



18*

ORO OPACO
Matt gold
Or opaque
Opak gold
Золото



61

NICKEL NERO SATINATO PERLA
Satin black nickel pearl
Noir satiné nickel perle
Satin schwarz nickel perle
Сатиновый черный никель жемчуг



* FINITURA DISPONIBILE IN 20 GG. / Finish available in 20 days
Finition disponible en 20 jours / Oberfläche lieferbar in 20 Tagen
Отделка доступна в течение 20 дней



Reversibile su richiesta / Reversible on request / Réversible sur demande / Umkehrbar auf Anfrage / Реверсивный по запросу



Su richiesta si realizzano aste porta asciugamani su misura, 20 gg

Customized towel rails are available on request, 20 days
Des porte-serviettes personnalisés sont disponibles sur demande, 20 jours
Handtuchhalter sind auf Anfrage erhältlich, 20 tagen
По запросу мы можем производить полотенцедержатели под размер 20 дней



• 08	25 → 44 cm	€ 188,00
• 08	47 → 100 cm	€ 210,00
• 18 - 57	25 → 44 cm	€ 245,00
• 18 - 57	47 → 100 cm	€ 265,00





HASHI

Designer: GIANLUCA PALUDI

Materiale: Barra ottone Ø 14 e Ø 8
Finiture: 08 - 18 - 23 -24 - 36 - 56
Fuori misura: Si

Material: Solid Brass Bar Ø14 and Ø8
Finishes: 08 - 18 - 23 -24 - 36 - 56
Customized: Yes

Matériel: laiton massif Bar Ø14 e Ø8
Finitions: 08 - 18 - 23 -24 - 36 - 56
Personnalisé: Oui

Material: aus massivem Messing Bar Ø14 und Ø8
Ausführungen: 08 - 18 - 23 -24 - 36 - 56
Kundenwunsch: Ja

Материал: латунь
Аксессуары: белая керамика
Покрытие: 08 - 18 - 23 -24 - 36 - 56
Негабаритный: да

HASHI

HS 45 08



HS 11 08



HS 13 08



HASHI

HS 09 08
HS 10 08
HS 30 08



HS 11 17
010 17



HS 11 56
HS 06 56



HS 07 24



HS 10 AP 23
HS 30 AP 23



HASHI

HS 11 23
HS 06 23



HS 45 18



HASHI

HS 10 AP 36
HS 30 AP 36





HS 04

Mensola acciaio Inox
Inox Shelf
Etagère en Inox
Ablage
Полка из нержавеющей стали
cm 60 L x 12 P x 3 H

• 08 - 23 - 24 - 36 € 92,00



HS 05

Asta porta asciugamani
Towel rail
Porte serviettes
Handtuchhalter
Полотенцедержатель
cm 60 L x 7 P x 3 H - INT. 57

• 08 - 23 - 24 € 76,00
• 18 - 56 - 36 € 100,00
• FN € 115,00



HS 45

Asta porta asciugamani
Towel rail
Porte serviettes
Handtuchhalter
Полотенцедержатель
cm 45 L x 7 P x 3 H - INT. 42

• 08 - 23 - 24 € 72,00
• 18 - 56 - 36 € 95,00
• FN € 108,00



HS 06

Asta porta salviette
Towel rail
Porte serviettes
Handtuchhalter
Полотенцедержатель
cm 30 L x 7 P x 3 H - INT. 27

• 08 - 23 - 24 € 70,00
• 18 - 56 - 36 € 94,00
• FN € 104,00



HS 13

Porta accappatoio
Robe hook
Porte peignoir
Bademantelhaken
Крючок
cm 2 L x 4,5 P x 2 H

• 08 - 23 - 24 € 20,00
• 18 - 56 - 36 € 30,00
• FN € 35,00



HS 11

Porta rotolo
Paper holder
Porte rouleau
Papierrollenhalter
Бумагодержатель
cm 20 L x 6 P x 3 H

• 08 - 23 - 24 € 69,00
• 18 - 56 - 36 € 92,00
• FN € 105,00



O10

Porta scopino
Toilet-brush
Porte balayent
Bürstengarnitur freistehend
Напольный керамический ёрш
cm Ø 8 x 40 H

• 08 - 23 - 24 € 89,00
• 18 - 56 - 36 € 115,00
• FN € 130,00



O10 M

Porta scopino a parete
Wall mounted toilet-brush
Porte balayent à mur
Bürstengarnitur wandhängend
Настенный металлический ёрш
cm Ø 8 x 40 H

• 08 - 23 - 24 € 98,00
• 18 - 56 - 36 € 125,00
• FN € 140,00



HS 07

Anello porta salviette
Ring serviette holder
Porte serviettes à anneau
Handtuchring
Полотенцедержатель - кольцо
cm Ø 20 x 7 P

• 08 - 23 - 24 € 79,00
• 18 - 56 - 36 € 110,00
• FN € 125,00



HS 09 M

Porta sapone a parete
Wall mounted soap dish
Porte savon à mur
Seifenschale wandhängend
Настенная металлическая мыльница
cm Ø 11 x 14 P x 3,5 H

• 08 - 23 - 24 € 94,00
• 18 - 56 - 36 € 125,00
• FN € 140,00



HS 10 M

Bicchiere a parete
Wall mounted glass holder
Porte verre à mur
Zahnbürstenhalter wandhängend
Настенный металлический стакан
cm Ø 6 x 11,5 H

• 08 - 23 - 24 € 65,00
• 18 - 56 - 36 € 95,00
• FN € 105,00



HS 30 M

Dosatore sapone liquido a parete
Wall mounted soap dispenser
Doseur de savon à mur
Seifenspender wandhängend
Настенный металлический дозатор
cm Ø 6 x 18 H

• 08 - 23 - 24 € 105,00
• 18 - 56 - 36 € 145,00
• FN € 165,00



HS 00

Basetta di rifinitura a muro
Plate
Rondelle murale
Scheibe
Отражатели
cm Ø 3

• 08 - 23 - 24 € 6,00
• 18 - 56 - 36 € 9,00
• FN € 12,00



HS 16

Porta asciugamani snodo 2 aste
Towel rail with 2 adjustable bar
Porte serviettes à 2 barres orientables
Handtuchhalter schwenkbar 2 Stangen
Полотенцедержатель двойной поворотный
cm 3 L x 33 P x 8 H - INT. 5

• 08 - 23 - 24 € 120,00
• 18 - 56 - 36 € 158,00
• FN € 185,00



HS 09 AP

Porta sapone da appoggio
Soap dish with base
Porte savon d'appui
Seifenschale freistehend
Настольная металлическая мыльница
cm Ø 11 x 3,5 H

• 08 - 23 - 24 € 49,00
• 18 - 56 - 36 € 70,00
• FN € 80,00



HS 10 AP

Bicchiere da appoggio
Glass with base
Verre d'appui
Zahnputzbecher freistehend
Настольный металлический стакан
cm Ø 6 x 11,5 H

• 08 - 23 - 24 € 50,00
• 18 - 56 - 36 € 84,00
• FN € 95,00



HS 30 AP

Dosatore sapone d'appoggio
Soap dispenser with base
Porte savon d'appui
Seifenspender freistehend
Настольный металлический дозатор
cm Ø 6 x 18 H

• 08 - 23 - 24 € 90,00
• 18 - 56 - 36 € 135,00
• FN € 155,00





OPZIONI E COMPLEMENTI / OPTIONS AND COMPLEMENTS / OPTIONS ET COMPLÉMENTS / OPTIONEN UND ERGÄNZUNGEN / варианты и дополнения



08

CROMO
Chrome
Chrom
хром

24

BIANCO OPACO
Matt white
Blanc opaque
Weiße
белый матовый

23

NERO OPACO
Matt black
Noir opaque
Mattschwarz
черный матовый

18*

ORO OPACO
Matt gold
Or opaque
Opak gold
хром

36*

NICKEL SATINATO
Satin nickel
Nickel satiné
Сатинированный никель



56*

NICKEL NERO
Black nickel
Nickel noir
Schwarzer Nickel
черный матовый



FN*

PROGETTO SARTORIA
Tailoring project
Finishes on request
finitions sur demande
Ausführungen auf Anfrage
отделка по запросу

FNPVD**

PROGETTO SARTORIA PVD+80% DAL 08
Tailoring project PVD
increase +80% on 08
augmentation +80% sur 08
Steigerung +80 % auf 08
рный матовый

* FINITURA DISPONIBILE IN 20 GG.
Finish available in 20 days Finition Disponible en 20 jours
Oberfläche lieferbar in 20 Tagen Отделка доступна в течение 20 дней

** FINITURA DISPONIBILE IN 40 GG.
Finish available in 40 days Finition Disponible en 40 jours
Oberfläche lieferbar in 40 Tagen Отделка доступна в течение 40 дней

1208

Specchio sagomato
Cut mirror
Miroir coupé
Geformter Spiegel
Декоративное зеркало
cm 86 L x 86 H

- € 270,00
- CE-LED-13 W - V220 - IP21 € 410,00

1209

Specchio ingranditore 3x con calamita
Enlarging mirror 3x with magnet
Miroir agrandisseur 3x avec aimant
Wandspiegel Vergrößerung 3x mit Magnet
3-кратное увеличительное зеркало с магнитом
cm Ø 14 x 10 P

- 08 € 110,00

1214

Struttura porta lavabo in ottone con mensola in legno
Brass support with wook shelf
Support avec étagère en bois
Waschbeckenhalterung aus Messing mit Holzablage
Латунная конструкция держателя
умыльальника с деревянной полкой
cm 60 L x 48 P x 77 H

- 08-23-24 € 620,00
- 18-56 € 890,00

830

Lavabo in ceramica tondo
Round ceramic washbasin
Lavabo ronde en céramique
Keramik Aufsatzwaschbecken rund
Круглая керамическая раковина
cm 40 Ø x 15 H

- BI € 240,00

RAC 393

Sifone tornito in ottone 1" ¼
Brass si phon 1" ¼
Siphon en laiton 1" ¼
Siphon aus Messing 1" ¼
Хромированный 1" ¼

€ 85,00



BI TO RO



830 BI
Ceramica - Bianco
Ceramic - White
Céramique - Blanc
Keramik - Weiß
Керамика - белый



URANIA

Designer: STILHAUS

Materiale: Ottone, tubo 12x12, basetta a muro 50x50
Accessori: Ceramica bianca
Finitura: 08-36-23
Fuori misura: Si
Incollo: Si

Material: Brass tube 12x12, fixing plate cover 50x50
Accessories: White ceramic
Finishes: 08-36-23
Customized: Yes
By glue: Yes

Matière: Laiton, tuyau 12x12, boucle couvre-vis 50x50
Accessoires: Blanc céramique Finitions: 08-36-23
Personnalisé: Oui
Par collage : Oui

Material: Messing Rohr 12x12,
Befestigungsplatten Oberfläche 50x50
Zubehör: Weiße Keramik
Ausführungen: 08-36-23
Kundenwunsch: Ja
Kleber: Ja

Материал: латунь сатин 12x12, 50x50
Аксессуары: белая керамика
Отделка: 08, 36, 23
Негабаритный: да
Установка на клей: да

URANIA

U 30 08
U 04 08



U 039 M 36



URANIA

U 06.2 08

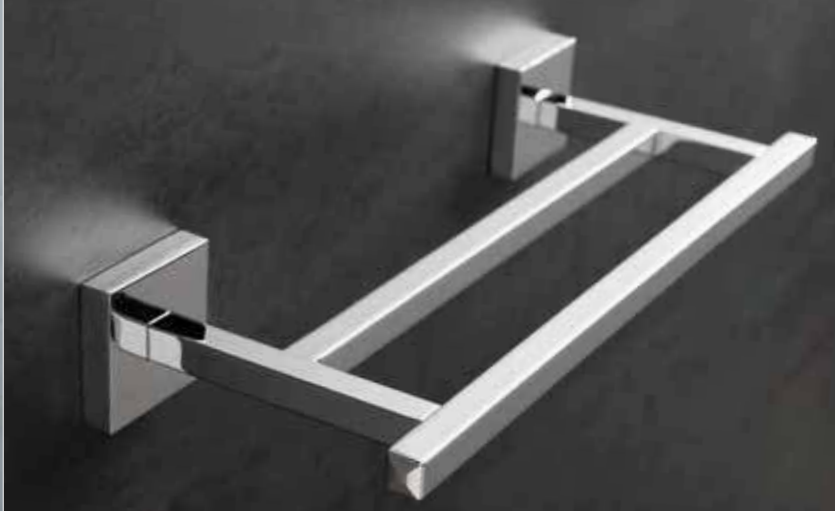

U 13.23





U 04

Mensola vetro 8mm
Shelf
Étagère
Ablage
ограждением- толщина стекла 8 мм
cm 60 L x 12 P x 8 H

• 08 - 23	€ 155,00
• 36	€ 195,00
• FN	€ 230,00



U 05

Asta porta asciugamani
Towel rail
Porte serviettes
Handtuchhalter
Полотенцедержатель
cm 60,5 L x 7,5 P x 5 H x 55,5 INT

• 08 - 23	€ 110,00
• 36	€ 140,00
• FN	€ 165,00

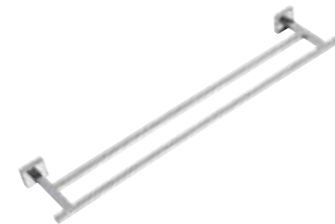

U 05.2

Porta asciugamani doppia asta
Double towel rail
Porte serviettes avec 2 bars
Handtuchstange doppelt
Полотенцедержатель двойной
cm 60,5 L x 11 P x 5 H x 55,5 INT

• 08 - 23	€ 165,00
• 36	€ 205,00
• FN	€ 248,00



U 45

Asta porta asciugamani
Towel rail
Porte serviettes
Handtuchhalter
Полотенцедержатель
cm 45,5 L x 7,5 P x 5 H x 40,5 INT

• 08 - 23	€ 100,00
• 36	€ 135,00
• FN	€ 150,00



U 06

Asta porta salviette
Towel rail
Porte serviettes
Handtuchhalter
Полотенцедержатель
cm 30,5 L x 7,5 P x 5 H x 25,3 INT

• 08 - 23	€ 99,00
• 36	€ 130,00
• FN	€ 148,00



U 06.2

Porta salviette doppia asta
Double towel rail
Porte serviettes avec 2 bars
Handtuchstange doppelt
Полотенцедержатель двойной
cm 30,5 L x 11 P x 5 H x 25,3 INT

• 08 - 23	€ 148,00
• 36	€ 188,00
• FN	€ 225,00



U 06.1

Asta porta salviette
Towel rail
Porte serviettes
Handtuchhalter
Полотенцедержатель двойной
cm 5 L x 26 P x 5 H

• 08 - 23	€ 72,00
• 36	€ 89,00
• FN	€ 109,00



U 16

Porta asciugamani snodo 2 aste
Towel rail with 2 adjustable bar
Porte serviettes à 2 barres orientables
Handtuchhalter schwenkbar 2 Stangen
Полотенцедержатель двойной поворотный
cm 5 L x 33 P x 8 H

• 08 - 23	€ 165,00
• 36	€ 205,00
• FN	€ 248,00



U 07

Anello porta salviette
Ring serviette
Porte serviettes à anneau
Handtuchring
Полотенцедержатель - кольцо
cm 20,5 Ø x 5,5 P x 24 H

• 08 - 23	€ 82,00
• 36	€ 105,00
• FN	€ 124,00



U 69

Porta salviette con porta sapone
Serviettes holder with soap dish
Porte serviettes avec porte savon
Handtuchhalter mit Seifenschale
Полотенцедержатель + керамическая мыльница
cm 39 L x 11 P x 7,5 H x 27 INT

• 08 - 23	€ 145,00
• 36	€ 185,00
• FN	€ 218,00



U 69 D

Porta salviette con dosatore sapone
Serviettes holder with soap dispenser
Porte serviettes avec doseur de savon
Handtuchhalter mit Seifenspender
Полотенцедержатель + керамический дозатор
cm 39 L x 11 P x 20,5 H x 27 INT

• 08 - 23	€ 215,00
• 36	€ 260,00
• FN	€ 320,00



U 09

Porta sapone a parete
Wall mounted ceramic soap dish
Porte savon à mur en céramique
Seifenschale wandhängend aus Keramik
Настенная керамическая мыльница
cm 10 L x 11 P x 7,5 H

• 08 - 23	€ 88,00
• 36	€ 115,00
• FN	€ 132,00



U 10

Porta bicchiere a parete
Wall mounted ceramic glass holder
Porte verre à mur en céramique
Zahnbürstenhalter wandhängend aus Keramik
Настенный керамический стакан
cm 7,5 L x 10 P x 15 H

• 08 - 23	€ 89,00
• 36	€ 115,00
• FN	€ 134,00



U 14

Porta sapone con Porta bicchiere a parete
Wall mounted soap dish + Glass holder
Porte savon + Porte verre à mur
Seifenschale + Zahnbürstenhalter wandhängend
Настенные керамические стакан + мыльница
cm 20 L x 11 P x 15 H

• 08 - 23	€ 148,00
• 36	€ 185,00
• FN	€ 225,00



U 14 D

Dosatore con Porta bicchiere a parete
Wall mounted soap dispenser + Glass holder
Porte savon liquide + Porte verre à mur
Seifenspender + Zahnbürstenhalter wandhängend
Настенные керамические стакан + дозатор
cm 19 L x 10 P x 22 H

• 08 - 23	€ 220,00
• 36	€ 260,00
• FN	€ 330,00



U 30

Dosatore sapone liquido a parete
Wall-mounted soap dispenser
Doseur de savon
Seifenspender
Настенный стеклянный дозатор
cm 7,5 L x 10 P x 23 H

• 08 - 23	€ 135,00
• 36	€ 165,00
• FN	€ 205,00





616
Porta sapone da appoggio
Soap dish with base
Porte savon d'appui
Seifenschale
Настольная керамическая мыльница
cm 10 L x 10 P x 5 H

• 08 - 23	€ 75,00
• 36	€ 95,00
• FN	€ 113,00



617
Bicchiere d'appoggio
Glass with base
Verre base
Zahnputzbecher
Настольный керамический стакан
cm 9 L x 9 P x 12 H

• 08 - 23	€ 76,00
• 36	€ 97,00
• FN	€ 114,00



618
Dosatore sapone liquido da appoggio
Soap dispenser with base
Doseur de savon d'appui
Seifenspender
Настольный керамический дозатор
cm 9 L x 9 P x 19 H

• 08 - 23	€ 125,00
• 36	€ 155,00
• FN	€ 188,00



U 13
Porta accappatoio
Robe hook
Porte peignoir
Bademantelhaken
Крючок
cm 5 L x 4,5 P x 5 H

• 08 - 23	€ 52,00
• 36	€ 68,00
• FN	€ 78,00



U 13.2
Porta accappatoio (2 ganci)
Robe hook (2 hooks)
Porte peignoir (2 peignoir)
Bademantelhaken (2 Haken)
Крючок двойной
cm 8 L x 7,5 P x 5 H

• 08 - 23	€ 69,00
• 36	€ 92,00
• FN	€ 104,00



U 11
Porta rotolo
Peper holder
Porte rouleau
Papierrollenhalter
Бумагодержатель
cm 16,5 L x 7,5 P x 5 H

• 08 - 23	€ 72,00
• 36	€ 92,00
• FN	€ 108,00



U 11 C
Porta rotolo con coperchio
Covered paper holder
Porte rouleau avec couvercle
Papierrollenhalter mit Deckel
Бумагодержатель закрытый
cm 13 L x 15 P x 12 H

• 08 - 23	€ 126,00
• 36	€ 170,00
• FN	€ 189,00



633 CUBE
Porta scopino in ceramica
Ceramic Toilet-brush
Porte balayent en ceramique
Bürstengarnitur wandhängend
Напольный керамический ёрш
cm 10 L x 10 P x 38 H

• 08 - 23	€ 97,00
• 36	€ 124,00
• FN	€ 146,00

OPZIONI E COMPLEMENTI / OPTIONS AND COMPLEMENTS / OPTIONS ET COMPLÉMENTS / OPTIONEN UND ERGÄNZUNGEN / варианты и дополнения



08

CROMO
Chrome
Chrome
Chrom
хром



23

NERO OPACO
Matt black
Noir opaque
Matt schwarz
черный матовый



36

NICHEL SATINATO
Satin nickel
Nickel satiné
Nickel satiniert
Никель сатин



Reversibile su richiesta
Reversible on request / Réversible sur demande /
Umkehrbar auf Anfrage / Реверсивный по запросу



FN*

PROGETTO SARTORIA
Tailoring project
Finishes on request
finitions sur demande
Ausführungen auf Anfrage
отделка по запросу

FN PVD**

PROGETTO SARTORIA PVD+80% DAL 08
Tailoring project PVD
increase +80% on 08
augmentation +80% sur 08
Steigerung +80 % auf 08
рный матовый

**** FINITURA DISPONIBILE IN 40 GG.**
Finish available in 40 days Finition Disponible en 40 jours
Oberfläche lieferbar in 40 Tagen Отделка доступна в течение 40 дней



Su richiesta si realizzano aste porta asciugamani su misura, 20 gg

Customized towel rails are available on request, 20 days
Des porte-serviettes personnalisés sont disponibles sur demande, 20 jours
Handtuchhalter sind auf Anfrage erhältlich, 20 Tagen
По запросу мы можем производить полотенцедержатели под размер 20 дней



> pag. 262



> pag. 329



> pag. 249



> pag. 471



> pag. 362



> pag. 376

• 08 - 23	25 → 44 cm	€ 145,00
• 08 - 23	46 → 90 cm	€ 175,00
• 36	25 → 44 cm	€ 170,00
• 36	46 → 90 cm	€ 220,00
• FN	25 → 44 cm	€ 218,00
• FN	46 → 90 cm	€ 260,00

U 039 M

Porta scopino a parete
Wall mounted toilet-brush
Porte balayent à mur
Bürstengarnitur wandhängend
Настенный металлический ёрш
cm 8 L x 9 P x 40 H

• 08 - 23	€ 198,00
• 36	€ 260,00
• FN	€ 295,00

U 039 Q

Porta scopino da appoggio
Toilet-brush with base
Porte balayent d'appui
Bürstengarnitur freistehend
Напольный металлический ёрш
cm 8 L x 9 P x 40 H

• 08 - 23	€ 178,00
• 36	€ 240,00
• FN	€ 265,00

U 11.2

Porta rotolo doppio
Double paper holder
Porte rouleau double
Papierrollenhalter doppelt
Бумагодержатель двойной
cm 25,5 L x 8,5 P x 5 H

• 08 - 23	€ 89,00
• 36	€ 115,00
• FN	€ 134,00

840

Kit collante e biadesivo per un articolo
Kit with bi-adhesive and glue for one article
Kit avec collant et biadhésif pour un article
Klebekit ist ein beidseitiger Klebestreifen
Возможность установки на клей. БИФДГШ

•	€ 4,80
---	--------

Possibilità di fissaggio ad incollo / Possibility of installation by glue / Possibilité de fixation par colle / Befestigungsmöglichkeit mit Klebstoff / возможность установки на клей



MEDEA

Designer: STILHAUS

Materiale: Ottone, tubo Ø 16, basetta a muro Ø 50
Accessori: Vetro Satinato
Finitura: 08 - 10 - 16 - 18 - 23 - 24 - 36
Fuori misura: Si
Incollo : Si

Material: Brass tube Ø 16, fixing plate cover Ø 50
Accessories: Frosted glass
Finishes: 08 - 10 - 16 - 18 - 23 - 24 - 36
Customized: Yes
By glue : Yes

Matière: Laiton, tuyau Ø 16, boucle couvre-vis Ø 50
Accessoires: Verre satin
Finitions: 08 - 10 - 16 - 18 - 23 - 24 - 36
Personnalisé: Oui
Par collage : Oui

Material: Messing Rohr Ø 16,
Befestigungsplatten Oberfläche Ø 50
Zubehör: Mattglas
Ausführungen: 08 - 10 - 16 - 18 - 23 - 24 - 36
Kundenwunsch: Ja
Kleber: Ja

Материал: латунь Ø 16, Ø 50
Аксессуары: сатинированное
стеклоОтделка: 08 - 10 - 16 - 18 - 23 - 24 - 36
матовыйНегабаритный: да
Установка на клей: да

MEDEA

ME 06 23



MEDEA

ME 30 08
ME 10 M 08
ME 09 M 08



ME 13 24



ME 79 08





ME 04

Mensola con vetro trasparente 8 mm
Shelf with transparent glass plane
Étagère avec plan en verre transparent
Ablage aus klarem Glas
Стеклянная полка с ограждением- толщина 8 мм
cm 60 L x 12 P x 5 H

• 08 - 23 - 24	€ 135,00
• 10 - 16 - 18 - 36	€ 185,00
• FN	€ 200,00



ME 05

Asta porta asciugamani
Towel rail
Porte serviette
Handtuchhalter
Полотенцедержатель
cm 61 L x 7 P x 5 H - INT. 56,50

• 08 - 23 - 24	€ 80,00
• 10 - 16 - 18 - 36	€ 112,00
• FN	€ 120,00



ME 05.2

Porta asciugamani doppia asta
Towel rail 2 bars
Porte serviette avec 2 bar
Handtuchhalter
Полотенцедержатель двойной
cm 61 L x 11 P x 5 H - INT. 56,50

• 08 - 23 - 24	€ 115,00
• 10 - 16 - 18 - 36	€ 179,00
• FN	€ 190,00



ME 45

Asta porta asciugamani
Towel rail
Porte serviette
Handtuchhalter
Полотенцедержатель
cm 48 L x 7 P x 5 H - INT. 43,50

• 08 - 23 - 24	€ 76,00
• 10 - 16 - 18 - 36	€ 107,00
• FN	€ 115,00



ME 06

Asta porta salviette
Towel rail
Porte serviettes
Handtuchhalter
Полотенцедержатель
cm 33 L x 7 P x 5 H - INT. 28,5

• 08 - 23 - 24	€ 73,00
• 10 - 16 - 18 - 36	€ 99,00
• FN	€ 110,00



ME 06.2

Porta salviette doppia asta
Towel rail 2 bars
Porte serviettes avec 2 bar
Handtuchhalter
Полотенцедержатель двойной
cm 33 L x 11 P x 5 H - INT. 28,50

• 08 - 23 - 24	€ 103,00
• 10 - 16 - 18 - 36	€ 140,00
• FN	€ 155,00



ME 69

Asta porta salviette con porta sapone
Towel rail with soap dish
Porte serviettes avec porte savon
Handtuchhalter mit Seifenschale
Полотенцедержатель + стеклянная мыльница
cm 48 L x 11 P x 4,5 H - INT. 43,50

• 08 - 23 - 24	€ 110,00
• 10 - 16 - 18 - 36	€ 150,00
• FN	€ 165,00



ME 16

Porta asciugamani a bandiera 2 aste
Towel rail with 2 adjustable bar
Porte serviettes à 2 barres orientables
Handtuchhalter schwenkbar 2 Stangen
Полотенцедержатель двойной оворотный
cm 33 L x 5 P x 9 H - INT. 5

• 08 - 23 - 24	€ 125,00
• 10 - 16 - 18 - 36	€ 169,00
• FN	€ 189,00

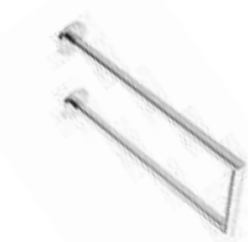

ME 60

Asta porta salviette
Towel rail
Porte serviettes
Handtuchhalter
Штанга для полотенец
cm 5 L x 25 P x 15 H - INT. 10

• 08 - 23 - 24	€ 80,00
• 10 - 16 - 18 - 36	€ 105,00
• FN	€ 120,00



ME 07

Anello porta salviette
Serviette holder to ring shaped
Porte serviettes à anneau
Handtuchring
Полотенцедержатель - кольцо
cm 20,5 Ø x 4,5 P x 22,5 H

• 08 - 23 - 24	€ 55,00
• 10 - 16 - 18 - 36	€ 75,00
• FN	€ 85,00



ME 79

Anello porta salviette/dosatore
Serviette holder with metal liquid soap dispenser
Porte serviettes à anneau avec doseur
Handtuchring mit Seifenspender aus Metall
Полотенцедержатель - кольцо + металлический дозатор
cm 23 Ø x 9 P x 29 H

• 08 - 23 - 24	€ 130,00
• 10 - 16 - 18 - 36	€ 180,00
• FN	€ 195,00



ME 09

Porta sapone in vetro
Glass soap dish
Porte savon en verre
Seifenschale aus Glas
Настенная стеклянная мыльница
cm 12 L x 12 P x 8 H

• 08 - 23 - 24	€ 72,00
• 10 - 16 - 18 - 36	€ 98,00
• FN	€ 108,00



ME 06.10



ME 11.18



ME 09 M

Porta sapone in ottone
Brass soap dish
Porte savon en laiton
Seifenschale aus Messing
Настенная металлическая мыльница
cm 12 L x 8 P x 9 H

• 08 - 23 - 24	€ 68,00
• 10 - 16 - 18 - 36	€ 90,00
• FN	€ 105,00



ME 10

Porta bicchiere in vetro
Glass holder
Porte verre
Zahnbürstenhalter aus Glas
Настенный стеклянный стакан
cm 8 L x 11 P x 11 H

• 08 - 23 - 24	€ 63,00
• 10 - 16 - 18 - 36	€ 85,00
• FN	€ 95,00



ME 10 M

Porta bicchiere in ottone
Brass glass holder
Porte verre en laiton
Zahnbürstenhalter aus Messing
Настенный металлический стакан
cm 7 L x 11 P x 11 H

• 08 - 23 - 24	€ 65,00
• 10 - 16 - 18 - 36	€ 88,00
• FN	€ 98,00



ME 30

Porta dosatore sapone liquido
Brass wall-mounted liquid soap dispenser
Doseur de savon liquide en laiton
Seifenspender aus Messing
Настенный металлический дозатор
cm 5 L x 9 P x 18 H

• 08 - 23 - 24	€ 97,00
• 10 - 16 - 18 - 36	€ 130,00
• FN	€ 145,00



ME 039

Porta scopino in ottone da appoggio
Brass toilet-brush with base
Porte balayent en laiton d'appui
Bürstengarnitur freistehend aus Messing
Напольный металлический ёрш
cm 8 Ø x 42 H

• 08 - 23 - 24	€ 84,00
• 10 - 16 - 18 - 36	€ 115,00
• FN	€ 129,00



ME 039 M

Porta scopino in ottone a parete
Wall mounted brass toilet-brush
Porte balayent à mur en laiton
Bürstengarnitur wandhängend aus Messing
Настенный металлический ёрш
cm 8 L x 9 P x 42 H

• 08 - 23 - 24	€ 92,00
• 10 - 16 - 18 - 36	€ 130,00
• FN	€ 145,00



ME 039 M INCOLLO

Porta scopino in ottone a parete da incollo
Glue wall mounted brass toilet-brush
Porte balayent à mur en laiton avec collant
Bürstengarnitur wandhängend aus Messing
Настенный металлический ёрш
cm 8 L x 9 P x 42 H

• 08 - 23 - 24	€ 107,00
• 10 - 16 - 18 - 36	€ 145,00
• FN	€ 160,00



840

Kit collante e biadesivo per un articolo
Kit with bi-adhesive and glue for one article
Kit avec collant et biadhésif pour un article
Klebekit ist ein beidseitiger Klebestreifen
Клей

•	€ 4,80
---	--------



ME 09 M AP

Porta sapone da appoggio
Leaning soap dish
Porte savon d'appui
Seifenschale freistehend
Настольная стеклянная мыльница
cm 13 Ø x 2,5 H

• 08	€ 49,00
• 10 - 16 - 18 - 23 - 24 - 36	€ 70,00
• FN	€ 80,00



ME 10 AP

Bicchiere porta spazzolini da appoggio
Leaning brass tooth-brush holder
Porte brosses de dents en laiton d'appui
Zahnbecher freistehend aus Messing
Настольный металлический стакан
cm 6,5 Ø x 11 H

• 08 - 23 - 24	€ 50,00
• 10 - 16 - 18 - 36	€ 84,00
• FN	€ 95,00



ME 30 AP

Dosatore sapone liquido da appoggio
Leaning brass liquid soap dispenser
Doseur de savon liquide en laiton d'appui
Seifenspender freistehend aus Messing
Настольный металлический дозатор
cm 6,5 Ø x 16 H

• 08 - 23 - 24	€ 90,00
• 10 - 16 - 18 - 36	€ 135,00
• FN	€ 155,00



ME 13

Porta accappatoio
Robe hook
Porte peignoir
Bademantelhaken
Настольный металлический дозатор
cm 5 L x 5 P x 4,5 H

• 08 - 23 - 24	€ 35,00
• 10 - 16 - 18 - 36	€ 47,00
• FN	€ 53,00

OPZIONI E COMPLEMENTI / OPTIONS AND COMPLEMENTS / OPTIONS ET COMPLÉMENTS / OPTIONEN UND ERGÄNZUNGEN / варианты и дополнения

* FINITURA DISPONIBILE IN 20 GG. / Finish available in 20 days / Finition disponible en 20 jours / Oberfläche lieferbar in 20 Tagen / Отделка доступна в течение 20 дней

** FINITURA DISPONIBILE IN 40 GG. / Finish available in 40 days Finition Disponible en 40 jours / Oberfläche lieferbar in 40 Tagen / Отделка доступна в течение 40 дней

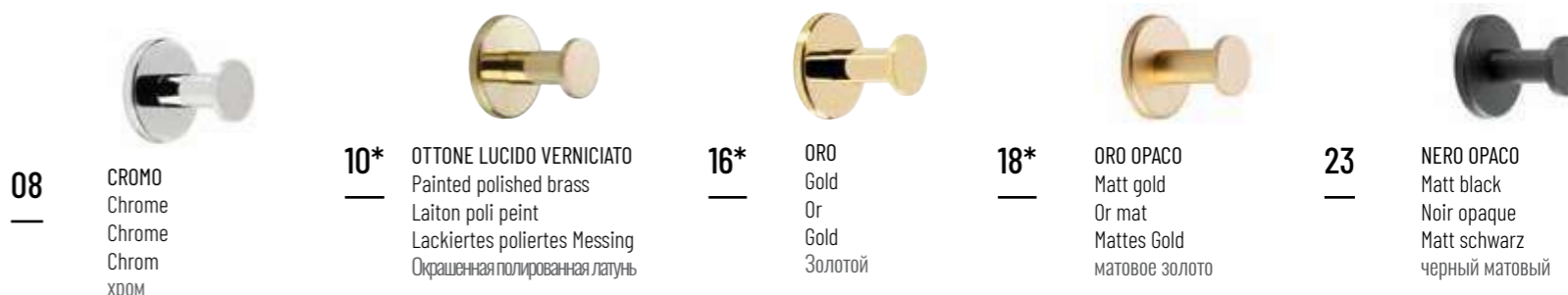

ME 808

Porta accappatoio (2 ganci)
Robe hook (2 hooks)
Porte peignoir (2 crochets)
Bademantelhaken (2 Haken)
Крючок гнутый
cm 5,5 L x 5,5 P x 5,5 H

• 08 - 23 - 24	€ 39,00
• 10 - 16 - 18 - 36	€ 55,00



ME 11

Porta rotolo
Paper holder
Porte rouleau
Papierrollenhalter
Бумагодержатель
cm 17 L x 7 P x 4,5 H

• 08 - 23 - 24	€ 52,00
• 10 - 16 - 18 - 36	€ 70,00
• FN	€ 79,00



ME 11 C

Porta rotolo coperto
Covered paper holder
Porte rouleau avec couvercle
Papierrollenhalter mit Deckel
Бумагодержатель с крышкой
cm 14 L x 12 P x 13 H

• 08 - 23 - 24	€ 79,00
• 10 - 16 - 18 - 36	€ 105,00
• FN	€ 119,00



ME 11.2

Porta rotolo doppio
Double paper holder
Porte rouleau double
Papierrollenhalter doppelt
Бумагодержатель двойной
cm 26 L x 7 P x 4,5 H

• 08 - 23 - 24	€ 79,00
• 10 - 16 - 18 - 36	€ 105,00
• FN	€ 119,00

Su richiesta si realizzano aste porta asciugamani su misura, 20 gg

Customized towel rails are available on request, 20 days
Des porte-serviettes personnalisés sont disponibles sur demande, 20 jours
Handtuchhalter sind auf Anfrage erhältlich, 20 tagen
По запросу мы можем производить полотенцедержатели под размер 20 дней

• 08 - 23	25 → 47 cm	€ 99,00
• 08 - 23	49 → 100 cm	€ 110,00
• 36	25 → 47 cm	€ 128,00
• 36	49 → 100 cm	€ 168,00



LIVING

BGR INDUSTRIAL DESIGN

Materiale: Barra alluminio 20x12 e ottone Ø 20
Accessori: Ceramica bianca
Finiture: 03-05-08-23-24
Fuori misura: No

Material: Solid aluminum 20x12 and brass
Accessories: white ceramic
Finishes: 03-05-08
Customized: No

Matériel: Aluminium massif 20x12 et laiton Ø 20
Accessoires: Blanc céramique finitions: 03-05-08-23-24
Personnalisé: No

Material: aus massivem Aluminium 20x12 aus Messing Ø 20
Zubehör: weiße Keramik
Ausführungen: 03-05-08-23-24
Kundenwunsch: Nein

Материал: алюминий и латунь 20x12 Ø 20
Аксессуары: белая керамика
Отделка: 03-05-08-23-24 хром
Негабаритный: нет

LV 45 08



LV 30 08
LV 10 08



LV 11 A 23



LV 13 08





LV 05

Asta porta asciugamani
Towel rail
Porte serviettes
Handtuchhalter
полотенцедержатель
cm 62 L x 7 P x 2 H - INT. 60

• 08-03-05-23-24 € 115,00



LV 45

Asta porta asciugamani
Towel rail
Porte serviettes
Handtuchhalter
полотенцедержатель
cm 45 L x 7 P x 2 H - INT. 45

• 08-03-05-23-24 € 103,00



LV 06

Asta porta salviette
Towel rail
Porte serviettes
Handtuchhalter
полотенцедержатель
cm 32 L x 7 P x 2 H - INT. 30

• 08-03-05-23-24 € 88,00



LV 69 D

Asta con dosatore sapone
Towel rail with liquid soap dispenser
Porte serviettes avec dosator de savon
Handtuchring mit Seifenspender
Полотенцедержатель + керамический дозатор
cm 35 L x 7 P x 21 H - INT. 30

• 08-03-05 € 168,00
• 08 A-03 A-05 A-23 A-24 A € 152,00



LV 11 A

Porta rotolo
Paper holder
Porte roleau
Papierrollenhalter
бумагодержатель
cm 20 L x 6,5 P x 2,5 H

• 08-03-05-23-24 € 78,00



LV 11

Porta rotolo
Paper holder
Porte roleau
Papierrollenhalter
бумагодержатель
cm 2 L x 12 P x 3,5 H

• 08-03-05-23-24 € 52,00



LV 12 A

Porta scopino d'appoggio in ceramica
Ceramic toilet brush
Porte balayent en ceramique
Bürstengarnitur freistehend aus Keramik
Напольный керамический ёрш
cm 10 L x 10 P x 42 H

• 08-03-05-23-24 € 98,00



LV 039M

Porta scopino a parete
Wall mounted toilet-brush
Porte balayent à mur
Bürstengarnitur wandhängend
Настенный металлический ёрш
cm 8 L x 8 P x 45 H

• 08-03-05-23-24 € 89,00

03 05



LV 69

Asta con porta sapone
Towel rail with soap dish
Porte serviettes avec porte savon
Handtuchhalter mit Seifenschale
Полотенцедержатель + керамическая мыльница
cm 37 L x 8 P x 4 H - INT. 30

• 08-03-05-23-24 € 126,00



LV 09

Porta sapone a parete
Wall mounted ceramic soap dish
Porte savon à mur en céramique
Seifenschale wandhängend aus Keramik
Настенная керамическая мыльница
cm 12 L x 9 P x 5 H

• 08-03-05-23-24 € 92,00



LV 10

Porta bicchiere a parete
Wall mounted ceramic glass holder
Porte verre à mur en céramique
Zahnbürstenhalter wandhängend aus Keramik
Настенный керамический стакан
cm 9 L x 7,5 P x 16 H

• 08-03-05-23-24 € 94,00



LV 30

Porta dosatore sapone liquido in ceramica
Ceramic liquid soap dispenser holder
Doseur de savon liquid en céramique
Seifenspender aus Keramik
Настенный керамический дозатор
cm 9 L x 7,5 P x 21,5 H

• 08 € 125,00
• 08 A-23 A-24 A € 115,00



LV 09 AP

Porta sapone d'appoggio
Soap dish
Porte savon
Seifenschale
Настольная керамическая мыльница
cm 12 L x 7 P x 2 H

• 08 € 22,00



LV 10 AP

Bicchiere d'appoggio
Glass
Verre
Zahnputzbecher
Настольный керамический стакан
cm 9 L x 6 P x 14,5 H

• 08 € 26,00



LV 30 AP

Dosatore sapone liquido d'appoggio
Liquid soap dispenser
Porte savon liquid
Seifenspender
Настольный керамический дозатор
cm 9 L x 6,5 P x 19 H

• 08 € 75,00
• 08 A-23 A-24 A € 58,00



LV 13

Porta accappatoio
Robe hook
Porte peignoir
Bodemantelhaken
Крючок
cm 2 L x 3,5 P x 3,5 H

• 08-03-05-23-24 € 30,00

OPZIONI E COMPLEMENTI / OPTIONS AND COMPLEMENTS / OPTIONS ET COMPLÉMENTS / OPTIONEN UND ERGÄNZUNGEN / варианты и дополнения



24



BIANCO OPACO
Matt white
Blanc opaque
Weiße
белый матовый

23



NERO OPACO
Matt black
Noir opaque
Mattschwarz
черный матовый

08



CROMO
Chrome
Chrome
Chrom
хром

03



BIANCO/CROMO
White/Chrome
Blanc/Chrome
Weiße/Chrom
белый /хром

05



NERO/CROMO
Black/Chrome
Noir/Chrome
schwarz Chrom
черный хром



Reversibile su richiesta / Reversible on request / Réversible sur demande / Umkehrbar auf Anfrage / Реверсивный по запросу



LV 69 03



ARIA

Designer: MASSIMILIANO SETTIMELLI

Materiale: ottone, TUBO 12x12, basetta a muro 50 x 50
Accessori: ceramica bianca
Finiture: 08
Fuori misura: Si
Incollo: Si

Material: Brass Bar 12x12,
fixing plate cover 50x50
Accessories: white ceramic
Finishes: 08
Customized: Yes
By glue: Yes

Matière: Laiton, tuyau 12x12, boucle couvre-vis 50x50
Accessoires: Blanc céramique
Finitions: 08
Personnalisé: Oui
Par collage: Oui

Material: Messing Rohr 12x12,
befestigungsplatten oberfläche 50x50
Zubehör: Weiße keramik
Ausführungen: 08
Kundenwunsch: Ja
Kleber: Ja

Дизайн: Massimiliano Settimelli
Материал: латунь
Аксессуары: белая керамика
Отделка: 08 хром
Негабаритный: да
Установка на клей: да

AR 11 08
AR 039 M 08



AR 14 08



AR 45 08



AR 16 08





AR 04

Mensola vetro 8 mm
Shelf
Etagère
Ablage
Стеклопанельная полка - толщина стекла 8 мм
cm 60 L x 13 P x 2 H

• 08 € 99,00



AR 05

Asta porta asciugamani
Towel rail
Porte serviettes
Handtuchhalter
Полотенцедержатель
cm 56 L x 7,5 P x 2 H - INT. 49

• 08 € 165,00



AR 45

Asta porta asciugamani
Towel rail
Porte serviettes
Handtuchhalter
Полотенцедержатель
cm 45 L x 7,5 P x 2 H - INT. 39

• 08 € 155,00



AR 06

Asta porta salviette
Towel rail
Porte serviettes
Handtuchhalter
Полотенцедержатель
cm 30 L x 7,5 P x 2 H - INT. 23

• 08 € 150,00



AR 11

Porta rotolo
Paper holder
Porte rouleau
Papierrollenhalter
Бумагодержатель
cm 18 L x 7,5 P x 2 H

• 08 € 82,00



AR 11 C

Porta rotolo con coperchio
Covered paper holder
Porte rouleau avec couvercle
Papierrollenhalter mit Deckel
Бумагодержатель с крышкой
cm 13 L x 13 P x 10 H

• 08 € 115,00



AR 039

Porta scopino ovale
Toilet-brush
Poret balayent d'appui
Bürstengarnitur freistehend
Напольный металлический ёрш
cm 10 L x 6,5 P x 47 H

• 08 € 209,00



AR 039 M

Porta scopino a parete
Wall mounted toilet-brush
Porte balayent à mur
Bürstengarnitur wandhängend
Настенный металлический ёрш
cm 10 L x 7,5 P x 47 H

• 08 € 228,00



AR 16

Porta asciugamani a snodo 2 aste
Towel rail with 2 adjustable bar
Porte serviettes à 2 barres orientables
Handtuchhalter schwenkbar 2 Stangen
Полотенцедержатель двойной поворотный
cm 34 L x 2,5 P x 8,5 H

• 08 € 165,00



AR 07

Anello porta salviette
Ring serviette holder
Porte serviettes à anneau
Handtuchring
Полотенцедержатель - полукольцо
cm 30 L x 7,5 P x 14,5 H

• 08 € 130,00



AR 09

Porta sapone a parete
Wall mounted soap dish
Porte savon à mur
Seifenschale wandhängend
Настенная керамическая мыльница
cm 18 L x 11 P x 4 H

• 08 bianco / white / blanc / weiß / белый € 110,00
• 08 nero / black / noir / schwarz / черный € 112,00



AR 10

Porta bicchiere a parete
Wall mounted glass holder
Porte verre à mur
Zahnbürstenhalter wandhängend
Настенный керамический стакан
cm 16 L x 10 P x 13 H

• 08 bianco / white / blanc / weiß / белый € 110,00
• 08 nero / black / noir / schwarz / черный € 112,00



AR 945

Porta scopino in ceramica
Ceramic Toilet-brush
Porte balayent en ceramique
Bürstengarnitur wandhängend
Напольный керамический ёрш
cm 13 L x 9 P x 46 H

• 08 bianco / white / blanc / weiß / белый € 99,00
• 08 nero / black / noir / schwarz / черный € 111,00



652

Porta sapone da appoggio
Soap dish with base
Porte savon d'appui
Seifenschale freistehend
Настольная керамическая мыльница
cm 13 L x 8 P x 2 H

• 08 bianco / white / blanc / weiß / белый € 21,00
• 08 nero / black / noir / schwarz / черный € 23,00



653

Bicchiere da appoggio
Glass with base
Verre d'appui
Zahnputzbecher freistehend
Настольный керамический стакан
cm 10 L x 7 P x 10 H

• 08 bianco / white / blanc / weiß / белый € 27,00
• 08 nero / black / noir / schwarz / черный € 29,00



654

Dosatore sapone d'appoggio
Soap dispenser with base
Porte savon d'appui
Seifenspender freistehend
Настольный керамический дозатор
cm 10 L x 7 P x 19 H

• 08 bianco / white / blanc / weiß / белый € 59,00
• 08 nero / black / noir / schwarz / черный € 63,00



AR 30

Dosatore sapone liquido a parete
Wall mounted soap dispenser
Doseur de savon à mur
Seifenspender wandhängend
Настенный керамический дозатор
cm 16 L x 10 P x 21 H

• 08 bianco / white / blanc / weiß / белый € 155,00
• 08 nero / black / noir / schwarz / черный € 159,00



AR 14

Porta sapone e porta bicchiere a parete
Wall mounted soap dish and tumbler
Porte savon et porte verre à mur
Seifenschale und Zahnbürstenhalter wandhängend
Настенные керамические мыльница + стакан
cm 28 L x 11 P x 13 H

• 08 bianco / white / blanc / weiß / белый € 140,00
• 08 nero / black / noir / schwarz / черный € 145,00



AR 13

Porta accappatoio (2 ganci)
Robe hook (2 hooks)
Porte peignoir (2 crochets)
Bademantelhaken (2 Haken)
Крючок двойной
cm 10 L x 7,5 P x 2 H

• 08 € 82,00



AR 13.1

Porta accappatoio
Robe hook
Porte peignoir
Bademantelhaken
Крючок
cm 2 L x 5 P x 4 H

• 08 € 47,00

OPZIONI E COMPLEMENTI / OPTIONS AND COMPLEMENTS / OPTIONS ET COMPLÉMENTS / OPTIONEN UND ERGÄNZUNGEN / варианты и дополнения



08-BI

CROMO - CER. BIANCO
Chrome - Cer. white
Chrome - Cér. blanc
Chrom - Ker. weiße
хром - белая керамика



08-NE

CROMO - CER. NERO
Chrome - Cer. black
Chrome - Cér. noir
Chrom - Ker. schwarz
хром - черная керамика



Reversibile su richiesta / Reversible on request / Réversible sur demande / Umkehrbar auf Anfrage / Реверсивный по запросу



Su richiesta si realizzano aste porta asciugamani su misura, 20 gg

Customized towel rails are available on request, 20 days
Des porte-serviettes personnalisés sont disponibles sur demande, 20 jours
Handtuchhalter sind auf Anfrage erhältlich, 20 Tagen
По запросу мы можем производить полотенцедержатели под размер 20 дней



• 08 25 → 44 cm € 175,00
• 08 46 → 100 cm € 195,00



SATURNO

Designer: STILHAUS

Materiale: Barra Inox 304,
Accessori: vetro satinato
Finitura: 54
Fuori misura: si

Material: Barra Inox 304
Accessories: Frosted Glass
Finishes: 54
Customized: si

Matériau: Bar d'acier 304
Accessoires: Verre satin
Finitions: 54
Personnalisé: Si

Material: Stahl Bar 304
Zubehör: Milchglas
Ausführungen: 54
Kundenwunsch: Ja

Материал: нержавеющая сталь
Аксессуары: сатинированное стекло
Покрытие: 54 сатинированная сталь
Негабаритный: да

SATURNO

ST 10 54
ST 30 54



SATURNO

ST 45 54



ST 11 54



ST 13 54





ST 04
Mensola con plexiglass satinato
Shelf
Étagère
Ablage
Полка из оргстекла
cm 60 L x 11 P x 2 H

• 54 € 120,00



ST 05
Asta porta asciugamani
Towel rail
Porte serviettes
Handtuchhalter
Полотенцедержатель
cm 58 L x 7 P x 1,5 H - INT. 58

• 54 € 79,00

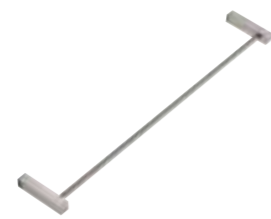

ST 45
Asta porta asciugamani
Towel rail
Porte serviettes
Handtuchhalter
Полотенцедержатель
cm 45 L x 7 P x 1,5 H - INT. 43

• 54 € 76,00



ST 06
Asta porta salviette
Towel rail
Porte serviettes
Handtuchhalter
Полотенцедержатель
cm 32 L x 7 P x 1,5 H - INT. 28

• 54 € 72,00



ST 039 M
Porta scopino a parete
Wall mounted toilet-brush
Porte balayent à mur
Bürstengarnitur wandhängend
Настенный металлический ёрш
cm ø 8 x 38 H

• 54 € 98,00



ST 17
Mensola con plexiglass satinato
Shelf
Étagère
Ablage
Полка из оргстекла
cm 32 L x 11 P x 2 H

• 54 € 120,00



ST 16
Porta asciugamani snodo 2 aste
Towel rail with 2 adjustable bar
Porte serviettes à 2 barres orientables
Handtuchhalter schwenkbar 2 Stangen
Полотенцедержатель двойной поворотный
cm 3 L x 33 P x 8 H

• 54 € 160,00



ST 09
Porta sapone a parete
Wall mounted ceramic soap dish
Porte savon à mur en céramique
Seifenschale wandhängend aus Keramik
Настенная керамическая мыльница
cm 10,5 L x 10,5 P x 4,5 H

• 54 € 98,00



ST 10
Porta bicchiere a parete
Wall mounted ceramic glass holder
Porte verre à mur en céramique
Zahnbürstenhalter wandhängend aus Keramik
Настенный керамический стакан
cm 7 L x 9,5 P x 11,5 H

• 54 € 100,00



ST 30
Dosatore sapone liquido a parete
Wall-mounted soap dispenser
Doseur de savon
Seifenspender
Настенный стеклянный дозатор
cm 7 L x 10 P x 20 H

• 54 € 125,00



ST 13
Porta accappatoio
Robe hook
Porte peignoir
Bademantelhaken
Крючок
cm 1,5 L x 3,5 P x 2,5 H

• 54 € 38,00



ST 11
Porta rotolo
Paper holder
Porte rouleau
Papierrollenhalter
Бумагодержатель
cm 16 L x 7 P x 4 H

• 54 € 85,00

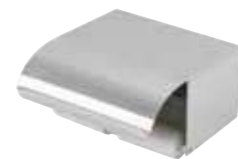

1005
Porta rotolo con coperchio
Covered paper holder
Porte rouleau avec couvercle
Papierrollenhalter mit Deckel
Бумагодержатель с крышкой
cm 12 L x 13 P x 6 H

• 54 € 45,00



ST 039
Porta scopino da appoggio
Ceramic toilet-brush with base
Porte balayent en céramique d'appui
Bürstengarnitur freistehend
Напольный металлический ёрш
cm ø 8 x 38 H

• 54 € 85,00

OPZIONI E COMPLEMENTI / OPTIONS AND COMPLEMENTS / OPTIONS ET COMPLÉMENTS / OPTIONEN UND ERGÄNZUNGEN / варианты и дополнения



Reversibile su richiesta / Reversible on request / Réversible sur demande / Umkehrbar auf Anfrage / Реверсивный по запросу



Su richiesta si realizzano aste porta asciugamani su misura, 20 gg

Customized towel rails are available on request, 5 days
Des porte-serviettes personnalisés sont disponibles sur demande, 5 jours
Handtuchhalter sind auf Anfrage erhältlich, 5 tagen
По запросу мы можем производить полотенцедержатели под размер 5 дней



• 54 25 → 44 cm € 82,00
• 54 46 → 80 cm € 89,00

ST 17 54





DIANA

Designer: STILHAUS

Materiale: Ottone, tubo ovale 20x10, basetta a muro 50x42
Accessori: Vetro Satinato
Finitura: 08
Fuori misura: Si
Incollo : Si

Material: Brass, tube 20x10, fixing plate cover 50x42
Accessories: Frosted glass
Finishes: 08
Customized: Yes
By glue : Yes

Matière: Laiton, tuyau 20x10, boucle couvre-vis 50x42
Accessoires: verre satin
Finitions: 08
Personnalisé: Oui
Par collage : Oui

Material: Messing, Rohr 20x10,
Befestigungsplatten Oberfläche 50x42
Zubehör: Mattglas
Ausführungen: 08
Kundenwunsch: Ja
Kleber: Ja

Материал: латунь
Аксессуары: сатинированное
стекло
Отделка: 08 хром
Негабаритный: да
Установка на клей: да

DI 06 08



DI 16 08



DI 11 08



DI 09 08
DI 10 08
DI 30 08



DI 04

Mensola vetro 8mm
Shelf
Étagère
Ablage
Стеклопанель полка - толщина стекла 8mm
cm 56 L x 13,5 P x 4 H

•08 € 99,00



DI 05

Asta porta asciugamani
Towel rail
Porte serviettes
Handtuchhalter
Полотенцедержатель
cm 63 L x 7 P x 4 H - INT. 55

•08 € 99,00



DI 45

Asta porta asciugamani
Towel rail
Porte serviettes
Handtuchhalter
Полотенцедержатель
cm 48 L x 7 P x 4 H - INT. 43

•08 € 94,00



DI 06

Asta porta salviette
Towel rail
Porte serviettes
Handtuchhalter
Полотенцедержатель
cm 33 L x 7 P x 4 H - INT. 28

•08 € 89,00



DI 809

Porta accappatoio (2 ganci)
Robe hook (2 hooks)
Porte peignoir (2 crochets)
Bademantelhaken (2 Haken)
Крючок
cm 5,5 L x 5,5 P x 5,5 H

•08 € 50,00



DI 11

Porta rotolo
Paper holder
Porte rouleau
Papierrollenhalter
Бумагодержатель
cm 16,5 L x 7,5 P x 4 H

•08 € 68,00



DI 11 C

Porta rotolo con coperchio
Covered paper holder
Porte rouleau avec couvercle
Papierrollenhalter mit Deckel
Бумагодержатель с крышкой
cm 17 L x 10 P x 9 H

•08 € 105,00



DI 039 M

Porta scopino a parete
Wall-mounted toilet-brush
Porte balayent à mur
Bürstengarnitur oval wandhängend
Настенный металлический ёрш
cm Ø 8 x 40,5 H

•08 € 98,00



DI 16

Porta asciugamani snodo 2 aste
Towel rail with 2 adjustable bar
Porte serviettes à 2 barres orientables
Handtuchhalter schwenkbar 2 Stangen
Полотенцедержатель двойной поворотный
cm 3 L x 33 P x 9 H

•08 € 148,00



DI 07

Anello porta salviette
Ring serviette
Porte serviettes à anneau
Handtuchring
Полотенцедержатель - кольцо
cm 20,5 Ø x 6,5 P x 22,5 H

•08 € 78,00



DI 09

Porta sapone a parete
Wall mounted soap dish
Porte savon à mur
Seifenschale wandhängend
Настенная стеклянная мыльница
cm 13 L x 11 P x 4 H

•08 € 70,00



DI 10

Porta bicchiere in vetro a parete
Wall-mounted glass holder
Porte verre à mur
Zahnputzhalter wandhängend
Настенный стеклянный стакан
cm 7,5 L x 11 P x 11 H

•08 € 79,00



DI 039

Porta scopino da appoggio
Toilet-brush with base
Porte balayent d'appui
Bürstengarnitur freistehend
Напольный металлический ёрш
cm Ø 8 x 40,5 H

•08 € 92,00



840

Kit collante e biadesivo per un articolo
Kit with bi-adhesive and glue for one article
Kit avec collant et biadhésif pour un article
Klebekit ist ein beidseitiger Klebestreifen
Клей

•08 € 4,80



DI 30

Dosatore sapone liquido a parete
Wall soap dispenser
Doseur de savon à mur
Seifenspender wandhängend
Настенный стеклянный дозатор
cm 8 L x 11 P x 19 H

•08 € 98,00



917

Porta sapone ovale da appoggio
Leaning oval soap dish
Porte savon ovale d'appui
Seifenschale oval freistehend
Настольная металлическая мыльница
cm 14 L x 8,5 P x 2 H

•08 € 46,00



918

Bicchieri ovale da appoggio
Leaning oval glass
Verre ovale d'appui
Zahnputzbecher oval freistehend
Настольный металлический стакан
cm 5,5 L x 8 P x 11 H

•08 € 74,00



919

Dosatore sapone liquido da appoggio
Leaning liquid soap dispenser
Porte savon liquid d'appui
Seifenspender freistehend
Настольный металлический дозатор
cm 5,5 L x 8 P x 16 H

•08 € 110,00

OPZIONI E COMPLEMENTI / OPTIONS AND COMPLEMENTS / OPTIONS ET COMPLÉMENTS / OPTIONEN UND ERGÄNZUNGEN / варианты и дополнения



08

CROMO
Chrome
Chrome
Chrom
ХРОМ



Reversibile su richiesta / Reversible on request / Réversible sur demande / Umkehrbar auf Anfrage / Реверсивный по запросу



Su richiesta si realizzano aste porta asciugamani su misura, 20 gg

Customized towel rails are available on request, 20 days
Des porte-serviettes personnalisés sont disponibles sur demande, 20 jours
Handtuchhalter sind auf Anfrage erhältlich, 20 Tagen
По запросу мы можем производить полотенцедержатели под размер 20 дней



•08 25 → 47 cm € 125,00
•08 49 → 100 cm € 145,00

Possibilità di fissaggio ad incollo / Possibility of installation by glue / Possibilité de fixation par colle / Befestigungsmöglichkeit mit Klebstoff / возможность установки на клей



DIVA

Designer: MASSIMILIANO SETTIMELLI

Materiale: ottone, TUBO 12x12, basetta a muro 50 x 50
Accessori: ceramica bianca
Finiture: 08
Fuori misura: Si
Incollo: Si

Material: Brass Bar 12x12,
fixing plate cover 50x50
Accessories: white ceramic
Finishes: 08
Customized: Yes
By glue: Yes

Matière: Laiton, tuyau 12x12, boucle couvre-vis 50x50
Accessoires: Blanc céramique
Finitions: 08
Personnalisé: Oui
Par collage: Oui

Material: Messing Rohr 12x12,
befestigungsplatten oberfläche 50x50
Zubehör: Weiße keramik
Ausführungen: 08
Kundenwunsch: Ja
Kleber: Ja

Дизайн: Massimiliano Settimelli
Материал: латунь
Аксессуары: белая керамика
Отделка: 08 хром
Негабаритный: да
Установка на клей: да

DIVA

DV 45 08



DV 07 08



DIVA

DV 10 08
DV 30 08





DV 04

Mensola 8 mm
Shelf
Etagère
Ablage
Стекло́нная полка - толщина стекла 8 mm
cm 60 L x 11 P x 2 H x 50 INT

•08 € 158,00



DV 05

Asta porta asciugamani
Towel rail
Porte serviettes
Handtuchhalter
полотенцедержатель + керамический дозатор
cm 61 L x 9 P x 5 H x 56,5 INT

•08 € 103,00



DV 45

Asta porta asciugamani
Towel rail
Porte serviettes
Handtuchhalter
полотенцедержатель - кольцо
cm 46 L x 9 P x 5 H x 41,5 INT

•08 € 99,00



DV 06

Asta porta salviette
Towel rail
Porte serviettes
Handtuchhalter
Полотенцедержатель двойной поворотный
cm 36,5 L x 9 P x 5 H x 31,5 INT

•08 € 94,00



DV 69

Asta con porta sapone
Towel rail with soap dish
Porte serviettes avec porte savon
Handtuchhalter mit Seifenschale
Полотенцедержатель + керамическая мыльница
cm 40 L x 12 P x 5 H x 31,5 INT

•08 € 146,00



DV 69 D

Asta con dosatore di sapone
Towel rail with liquid soap dispenser
Porte serviettes avec dosator de savon
Handtuchhalter mit Seifenspender
Полотенцедержатель + керамический дозатор
cm 40 L x 11 P x 2 H x 31,5 INT

•08 € 188,00



DV 07

Anello porta salviette
Serviette holder to ring shaped
Porte serviettes à anneau
Handtuchring
полотенцедержатель - кольцо
cm 25 L x 6 P x 21 H

•08 € 135,00



DV 16

Porta asciugamani a snodo 2 aste
Towel rail with 2 adjustable bar
Porte serviettes à 2 barres orientables
Handtuchhalter schwenkbar 2 Stangen
Полотенцедержатель двойной поворотный
cm 33 L x 11 P x 2 H x 5 INT

•08 € 166,00



DV 09

Porta sapone a parete
Wall ceramic soap dish
Porte savon en céramique
Seifenschale wandhängend
Настенная керамическая мыльница
cm 13 L x 10 P x 6 H

•08 € 94,00



DV 10

Porta bicchiere a parete
Wall tooth brush holder
Porte verre en céramique
Zahnbürstenhalter wandhängend
Настенный керамический стакан
cm 8 L x 10 P x 15 H

•08 € 95,00



DV 30

Porta dosatore sapone liquido in ceramica
Ceramic liquid soap dispenser holder
Doseur de savon liquid en céramique
Seifenspender aus Keramik
Настенный керамический дозатор
cm 8 L x 8 P x 18 H

•08 € 120,00



DV 14

Porta sapone e porta bicchiere a parete
Wall mounted soap dish and tumbler
Porte savon et porte verre à mur
Seifenschale und Zahnbürstenhalter wandhängend
Настенные керамические мыльница + стакан
cm 23 L x 10 P x 15 H

•08 € 155,00



DV 11 08
DV 12 A 08



DV 09 AP

Porta sapone d'appoggio
Soap dish
Porte savon
Seifenschale
Настольная керамическая мыльница
cm 12 L x 8 P x 2 H

•08 € 24,00



DV 10 AP

Bicchiere d'appoggio
Glass
Verre
Zahnputzbecher
Настольный керамический стакан
cm 9 L x 8 P x 11,5 H

•08 € 29,00



DV 30 AP

Dosatore sapone liquido d'appoggio
Liquid soap dispenser
Porte savon liquid
Seifenspender
Настольный керамический дозатор
cm 9 L x 8,5 P x 11,5 H

•08 € 56,00



DV 14 AP

Vaschetta porta oggetti
Tray plateau tablet
Tablet
Tablet
Настольный керамический лоток
cm 20 L x 10 P x 2 H

•08 € 29,00



DV 13

Porta accappatoio
Robe hook
Porte peignoir
Bademantelhaken
Крючок
cm 5 L x 6 P x 5 H

•08 € 52,00



DV 11

Porta rotolo
Paper holder
Porte rouleau
Papierrollenhalter
Бумагодержатель
cm 18 L x 9 P x 5 H

•08 € 72,00



DV 11C

Porta rotolo con coperchio
Covered paper holder
Porte rouleau avec couvercle
Papierrollenhalter mit Deckel
Бумагодержатель с крышкой
cm 13 L x 14 P x 12 H

•08 € 130,00



DV 11 S

Porta rotolo scorta
Paper holder of supply
Porte rouleau s'escorte
Ersatzpapierrollenhalter
Настенный вертикальный бумагодержатель
cm 5 L x 9 P x 18 H

•08 € 72,00



DV 12 A

Porta scopino d'appoggio in ceramica
Ceramic toilet brush
Porte balayent en ceramique
Bürstengarnitur freistehend aus keramik
Напольный керамический ёрш
cm 10 L x 10 P x 40 H

•08 € 104,00



DV 039 M

Porta scopino a parete
Wall ceramic toilet brush
Porte balayent à mur
Bürstengarnitur wandhängend
Настенный металлический ёрш
cm 8 L x 8 P x 39 H

•08 € 195,00



DV 039

Porta scopino d'appoggio
Ceramic toilet brush
Porte balayent
Bürstengarnitur freistehend
Напольный металлический ёрш
cm 8 L x 8 P x 39 H

•08 € 178,00



840

Kit collante e biadesivo per un articolo
Kit with bi-adhesive and glue for one article
Kit avec collant et biadhésif pour un article
Klebekit ist ein beidseitiger Klebestreifen
Клей

• € 4,80



OPZIONI E COMPLEMENTI / OPTIONS AND COMPLEMENTS / OPTIONS ET COMPLÉMENTS / OPTIONEN UND ERGÄNZUNGEN / варианты и дополнения



Su richiesta si realizzano aste porta asciugamani su misura, 20 gg

Customized towel rails are available on request, 15 days
Des porte-serviettes personnalisés sont disponibles sur demande, 15 jours
Handtuchhalter sind auf Anfrage erhältlich, 15 tagen
По запросу мы можем производить полотенцедержатели под размер 15 дней



•08 25 → 45 cm € 127,00
•08 47 → 100 cm € 142,00



> pag. 274



> pag. 248



> pag. 331



> pag. 462



> pag. 462

BUCKET

Designer: GIOVANNA TALOCCI

Materiale: Piatto ottone / INOX 304 , 25x4
Accessori: ceramica bianca
Finiture: 02 - 03 - 05 - 08 - 20 - 23 - 24 - 54 - 58 - 59
Fuori misura: No

Material: Brass / stainless steel plate 304 , 25x4
Accessories: white ceramic
Finishes: 02 - 03 - 05 - 08 - 20 - 23 - 24 - 54 - 58 - 59
Customized: No

Matériel: Plaque en laiton / acier inoxydable 304, 25x4
Accessoires: blanc céramique
Finitions: 02 - 03 - 05 - 08 - 20 - 23 - 24 - 54 - 58 - 59
Personnalisé: No

Material: Messing-/Edelstahlplatte 304 , 25x4
Zubehör: weiße Keramik
Ausführungen: 02 - 03 - 05 - 08 - 20 - 23 - 24 - 54 - 58 - 59
Kundenwunsch: Nein

Материал: Пластина из латуни / нержавеющей стали 304, 25x4
Аксессуары: белая керамика
Отделка: 02 - 03 - 05 - 08 - 20 - 23 - 24 - 54 - 58 - 59
Негабаритный: нет

BUCKET

BK 45 08



BUCKET

BK 14 08



BK 11 08



BK 13 08



BUCKET

BK 45 60

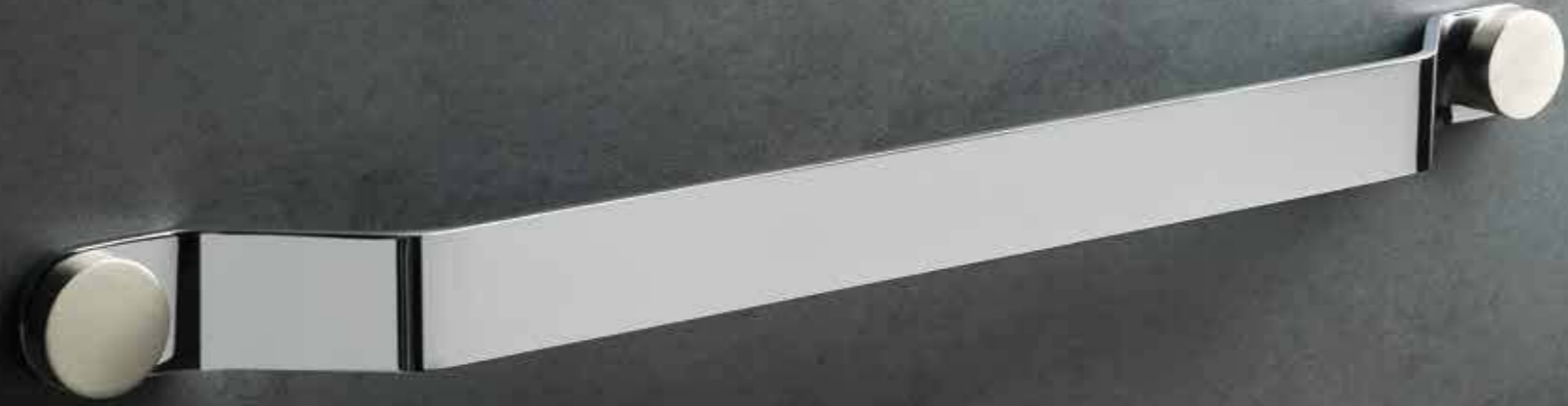

BUCKET

BK 10 23 NEOP



BK 11 59



BK 06 24



BK 09 03 BIOP



BUCKET INOX 304

BK 45 54



BUCKET INOX 304

BK 30 54 BI OP



BK 06 54



BK 11 54





BK 04

Mensola vetro
Shelf
Etagère
Ablage
Стеклоянная полка
cm 60 L x 12 P x 5 H

• 23 - 24	€ 65,00
• 08 - 54	€ 76,00
• 02 - 03 - 05 - 20 - 58 - 59	€ 84,00



BK 05

Asta porta asciugamani
Towel rail
Porte serviettes
Handtuchhalter
Полотенцедержатель
cm 56,5 L x 4 P x 3 H - INT. 54

• 23 - 24	€ 90,00
• 08 - 54	€ 115,00
• 02 - 03 - 05 - 20 - 58 - 59	€ 128,00



BK 45

Asta porta asciugamani
Towel rail
Porte serviettes
Handtuchhalter
Полотенцедержатель
cm 45 L x 4 P x 3 H - INT. 43

• 23 - 24	€ 88,00
• 08 - 54	€ 103,00
• 02 - 03 - 05 - 20 - 58 - 59	€ 115,00



BK 06

Asta porta salviette
Towel rail
Porte serviettes
Handtuchhalter
Полотенцедержатель
cm 34 L x 4 P x 3 H

• 23 - 24	€ 56,00
• 08 - 54	€ 67,00
• 02 - 03 - 05 - 20 - 58 - 59	€ 74,00



BK 13

Porta accappatoio
Robe hook
Porte peignoir
Bademantelhaken
Крючок
cm 3 L x 4,5 P x 12 H

• 23 - 24	€ 40,00
• 08 - 54	€ 50,00
• 02 - 03 - 05 - 20 - 58 - 59	€ 55,00



BK 11

Porta rotolo
Paper holder
Porte rouleau
Papierrollenhalter
Бумагодержатель
cm 20 L x 6 P x 3 H

• 23 - 24	€ 52,00
• 08 - 54	€ 58,00
• 02 - 03 - 05 - 20 - 58 - 59	€ 63,00



BK 12 A

Porta scopino in ceramica
Ceramic Toilet-brush
Porte balayent en ceramique
Bürstengarnitur freisehend
Напольный керамический ёрш
cm Ø 10 x 42 H

• 23 - 24	€ 99,00
• 08 - 54	€ 108,00
• 02 - 03 - 05 - 20 - 58 - 59	€ 120,00



BK 039 M

Porta scopino a parete
Wall mounted toilet-brush
Porte balayent à mur
Bürstengarnitur wandhängend
Настенный металлический ёрш
cm Ø 8 x 44 H

• 23 - 24	€ 83,00
• 08 - 54	€ 99,00
• 02 - 03 - 05 - 20 - 58 - 59	€ 126,00

OPZIONI E COMPLEMENTI / OPTIONS AND COMPLEMENTS / OPTIONS ET COMPLÉMENTS / OPTIONEN UND ERGÄNZUNGEN / варианты и дополнения



23



NERO OPACO
Matt black
Noir opaque
Mattschwarz
черный матовый

24



BIANCO OPACO
Matt white
Blanc opaque
Weiße
белый матовый

08



CROMO
Chrome
Chrome
Chrom
хром

02



CROMO + ORO
Chrome - Gold
Chrome - Or
Chrom - Gold
хром - золото

03



CROMO + BIANCO
Chrome - White
Chrome - Blanc
Chrom - Weiß
хром - белый

05



CROMO + NERO OPACO
Chrome - Matt black
Chrome - Noir mat
Chrom - Mattschwarz
Хром - матовый черный

58



CROMO + NICHEL NERO LUCIDO
Chrome - Nickel glossy black
Chrome - Nickel noir brillant
Chrom - Nickel glänzend schwarz
Хром - Никель глянцевый черный

20



CROMO + ORO OPACO
Chrome - Matt gold
Chrome - Or mat
Chrom - Mattgold
хром - матовое золото

59



NERO OPACO + ORO OPACO
Matt black - Matt gold
Noir mat - Or mat
Mattschwarz - Mattgold
матовое черное - матовое золото

54



ACCIAIO INOX 304 SATINATO
304 satin stainless steel
Acier inoxydable 304 satiné
Edelstahl 304 satiniert
304 сатинированная нержавеющая сталь

Disponibili in neolite opaco (maggiorazione)
Available in matt neolite (supplement)
Disponible en néolite mat (supplément)
Erhältlich in matted Neolith (Zuschlag)
Доступен в матовом неолитовом цвете (дополнительно)

•	€ 50,00
---	---------

BIOP



BIANCO OPACO
Matt white
Blanc mat
Mattweiß
матовый белый

NEOP



NERO OPACO
Matt black
Noir mat
Mattschwarz
матовый черный



BK 07

Anello porta salviette
Ring serviette holder
Porte serviettes à anneau
Handtuchring
Полотенцедержатель - кольцо
cm 23 L x 7 P x 33 H

• 23 - 24	€ 72,00
• 08 - 54	€ 83,00
• 02 - 03 - 05 - 20 - 58 - 59	€ 88,00



BK 09

Porta sapone a parete in ceramica
Wall-mounted ceramic soap dish
Porte-savon mural en céramique
Keramik-Seifenschale für die Wandmontage
Настенная керамическая мыльница
cm 17 L x 12 P x 6 H

• 23 - 24	€ 64,00
• 08 - 54	€ 76,00
• 02 - 03 - 05 - 20 - 58 - 59	€ 80,00



BK 10

Porta bicchiere a parete in ceramica
Wall-mounted ceramic cup holder
Porte-gobelet mural en céramique
Keramik-Tassenhalter für die Wandmontage
Настенный керамический подстаканник
cm 15 L x 10 P x 13 H

• 23 - 24	€ 64,00
• 08 - 54	€ 76,00
• 02 - 03 - 05 - 20 - 58 - 59	€ 80,00



BK 30

Dosatore sapone liquido a parete in ceramica
Wall-mounted ceramic liquid soap dispenser
Distributeur mural de savon liquide en céramique
Wandmontierter Flüssigseifenspender aus Keramik
Настенный керамический дозатор для жидкого мыла
cm 16 L x 10 P x 20 H

• 23 - 24	€ 94,00
• 08 - 54	€ 105,00
• 02 - 03 - 05 - 20 - 58 - 59	€ 132,00



BK 14

Porta sapone e porta bicchiere a parete in ceramica
Wall-mounted ceramic soap dish and glass holder
Porte-savon mural en céramique et porte-verre
Keramikseifenschale und Glashalter für die Wandmontage
Настенная керамическая мыльница и держатель для стаканов
cm 30 L x 12 P x 13 H

• 23 - 24	€ 115,00
• 08 - 54	€ 132,00
• 02 - 03 - 05 - 20 - 58 - 59	€ 137,00



BK 09 AP

Porta sapone da appoggio in ceramica
Ceramic countertop soap dish
Porte-savon de comptoir en céramique
Seifenschale aus Keramik für die Arbeitsplatte
Мыльница с керамической столешницей
cm Ø 12 x 3,5 H

• 08	€ 21,00
------	---------



BK 10 AP

Bicchiere da appoggio in ceramica
Ceramic table-top tumbler
Gobelet de table en céramique
Keramischer Tischbecher
Керамический настольный стакан
cm Ø 9 x 10 H

• 08	€ 21,00
------	---------



BK 30 AP

Dosatore sapone d'appoggio in ceramica
Ceramic soap dispenser
Distributeur de savon en céramique
Seifenspender aus Keramik
Керамический дозатор для мыла
cm Ø 9 x 18 H

• 08 - 23 - 24	€ 55,00
• 02 - 58 - 20 - 54	€ 81,00

LIZ

Designer: MASSIMILIANO SETTIMELLI

Materiale: Ottone, tubo ø16, basetta a muro ø 50
Accessori: Ceramica bianca
Finitura: 08
Fuori misura: Sì
Incollo : Sì

Material: Brass tube ø 16, fixing plate cover ø 50
Accessories: White ceramics
Finishes: 08
Customized: Yes
By glue : Yes

Matière: Laiton, tuyau ø 16, boucle couvre-vis ø 50
Accessoires: Céramique blanche
Finitions: 08
Personnalisé: Oui
Par collage : Oui

Material: Messing Rohr ø 16,
Befestigungsplatten Oberfläche ø 50
Zubehör: Weiße Keramik
Ausführungen: 08
Kundenwunsch: Ja
Kleber: Ja

Используемый материал: латунь ø 16, ø 50
Аксессуары: сатиновое стеклоОтделка: 08 хромНегабаритный: да
Установка на клей: да

LIZ

LZ 45 08



LIZ

LZ 09 08
LZ 10 08



LZ 13 08

LZ 11 08



**LZ 04**

Mensola vetro 8mm
Shelf
Étagère
Ablage
Стеклопанельная полка- толщина стекла 8 мм
cm 60 L x 12 P x 5 H

•08 € 78,00

**LZ 05**

Asta porta asciugamani
Towel rail
Porte serviettes
Handtuchhalter
Полотенцедержатель
cm 63 L x 8 P x 5 H x 56,5 INT

•08 € 65,00

**LZ 05.2**

Asta porta asciugamani con 2 aste
Chromed towel rail with 2 bar
Porte serviettes chromée à 2 barres
Handtuchhalter 2 Stangen
Полотенцедержатель двойной
cm 65 L x 13 P x 6 H x 60 INT

•08 € 99,00

**LZ 45**

Asta porta asciugamani
Towel rail
Porte serviettes
Handtuchhalter
Полотенцедержатель
cm 50 L x 8 P x 5 H x 45 INT

•08 € 62,00

**LZ 45.2**

Asta porta asciugamani con 2 aste
Chromed towel rail with 2 bar
Porte serviettes chromée à 2 barres
Handtuchhalter 2 Stangen
Полотенцедержатель двойной
cm 48 L x 13 P x 6 H x 43 INT

•08 € 94,00

**LZ 06**

Asta porta salviette
Towel rail
Porte serviettes
Handtuchhalter
Полотенцедержатель
cm 36 L x 8 P x 5 H x 31 INT

•08 € 59,00

**LZ 06.2**

Asta porta salviette con 2 aste
Chromed towel rail with 2 bar
Porte serviettes chromée à 2 barres
Handtuchhalter 2 Stangen
Полотенцедержатель двойной
cm 36 L x 8 P x 6 H x 31 INT

•08 € 88,00

**LZ 06.1**

Asta porta salvietta singola
Single towel rail
Porte serviettes
Handtuchhalter
Полотенцедержатель
cm 5,5 L x 30 P x 5,5 H

•08 € 55,00

**LZ 16**

Porta asciugamani snodo 2 aste
Towel rail with 2 adjustable bar
Porte serviettes à 2 barres orientables
Handtuchhalter schwenkbar 2 Stangen
Полотенцедержатель двойной поворотный
cm 3 L x 33 P x 8 H - INT. 5

•08 € 125,00

**LZ 07**

Anello porta salviette
Ring serviette holder
Porte serviettes à anneau
Handtuchring
Полотенцедержатель - кольцо
cm 20,5 Ø x 4,5 P x 22,5 H

•08 € 55,00

**LZ 09**

Porta sapone a parete
Wall-mounted soap dish
Porte savon à mur
Seifenschale wandhängend
Настенная керамическая
cm 13,5 L x 10,5 P x 9 H

•08 € 60,00

**LZ 09 M**

Porta sapone a parete
Wall-mounted soap dish
Porte savon à mur
Seifenschale
Настенная металлическая мыльница
cm 12 L x 10 P x 5 H

•08 € 65,00

**LZ 10**

Porta bicchiere a parete
Wall-mounted glass holder
Porte verre à mur
Zahnbürstenhalter wandhängend
Настенный керамический
cm 8 L x 11 P x 17 H

•08 € 64,00

**LZ 30**

Dosatore sapone liquido a parete
Wall-mounted soap dispenser
Doseur de savon
Seifenspender
Настенный керамический дозатор
cm 8 L x 11 P x 23 H

•08 € 82,00

**LZ 09 AP**

Porta sapone d'appoggio
Soap dish
Porte savon
Seifenschale
Настольная керамическая мыльница
cm 13,5 L x 9 P x 2 H

•01 € 23,00

**LZ 10 AP**

Bicchieri d'appoggio
Glasses
Verre
Zahnputzbecher
Настольный керамический стакан
cm Ø 8 x 11,5 H

•01 € 24,00



LZ 45.2 08



**LZ 30 AP**

Dosatore sapone liquido d'appoggio
Liquid soap dispenser
Porte savon liquid
Seifenspender
Настольный керамический дозатор
cm Ø 8 x 17 H

•08 € 58,00

**LZ 34**

Supporto: p. sapone/bicchieri/dosatore
Support: soap/glass/soap dispenser holder
Supporte: p. savon/verre/doseur
Halter: Seifenschale/Zahnputzbecher/Seifenspender
Настенный держатель для мыльницы/
дозатора /стакана
cm 7 L x 10 P x 5 H

•08 € 36,00

**LZ 35**

Supporto doppio: p. sapone/bicchieri/dosatore
Double support: soap/glass/soap dispenser holder
Supporte double: p. savon/verre/doseur
Doppelhalter: Seifenschale/Zahnputzbecher/
Seifenspender
Настенный держатель двойной для
мыльницы/дозатора/стакана
cm 22 L x 10 P x 5 H

•08 € 48,00

**LZ 041.08**

Porta sapone in vetro
Glass soap dish
Porte savon en verre
Seifenschale aus Glas
Стеклянная мыльница
cm 12 L x 12 P x 4 H

•08 € 13,00

**LZ 11 S**

Porta rotolo di scorta
Supply paper holder
Porte rouleau d'escorte
Ersatzpapierrollenhalter
Бумагодержатель вертикальный
cm 7 L x 10 P x 23 H

•08 € 59,00

**LZ 11.2**

Porta rotolo doppio
Double paper holder
Porte rouleau double
Papierrollenhalter doppelt
Бумагодержатель двойной
cm 26 L x 7 P x 4,5 H

•08 € 79,00

**LZ 039**

Porta scopino da appoggio
Toilet-brush with base
Porte balayent d'appui
Bürstengarnitur freistehend
Напольный металлический ёрш
cm 8 L x 8 P x 40 H

•08 € 84,00

**LZ 039 M**

Porta scopino a parete
Wall mounted toilet-brush
Porte balayent à mur
Bürstengarnitur wandhängend
Настенный металлический ёрш
cm 8 L x 9 P x 40 H

•08 € 92,00
•08 - incollo € 110,00

**LZ 040.06**

Bicchieri in vetro
Glass holder
Porte verre
Zahnbürstenhalter aus Glas
Стеклянный стакан
cm 6 L x 6 P x 8 H

•08 € 13,00

**LZ 037.01**

Dosatore sapone liquido in vetro con
pompetta metallo
Glass liquid soap dispenser with chrome pomp
Doseur de savon liquid en verre avec pompe
Seifenspender aus Glas
Стеклянный дозатор
cm 8 L x 8 P x 9 H

•08 € 41,00

**LZ 13**

Porta accappatoio
Robe hook
Porte peignoir
Bademantelhaken
Крючок
cm 5,5 L x 2 P x 5,5 H

•08 € 29,00

**LZ 809**

Porta accappatoio (2 ganci)
Robe hook (2 hooks)
Porte peignoir (2 crochets)
Bademantelhaken (2 Haken)
Крючок гнутый
cm 5,5 L x 5,5 P x 5,5 H

•08 € 36,00

**VE 039 PRATIKO**

Porta scopino da appoggio con manico
telescopico
Toilet-brush with telescopic handle
Porte balayent d'appui avec poignée télescopic
Bürstengarnitur freistehend mit Teleskopgriff
Напольный металлический ёрш
cm 12 L x 12 P x 52,5 H

•08 € 125,00

**VE 039 M PRATIKO**

Porta scopino a parete con manico
telescopico Pratico
Wall mounted toilet-brush with telescopic handle
Porte balayent à mur avec poignée télescopic
Bürstengarnitur wandhängend mit Teleskopgriff
Настенный стеклянный ёрш
cm 9 L x 12 P x 48 H

•08 € 135,00

**VE 12**

Porta scopino a parete con manico
telescopico Pratico
Wall mounted toilet-brush with telescopic handle
Porte balayent à mur avec poignée télescopic
Bürstengarnitur wandhängend mit Teleskopgriff
Настенный стеклянный ёрш
cm 9 L x 12 P x 48 H

•08 € 175,00

**840**

Kit collante e biadesivo per un articolo
Kit with bi-adhesive and glue for one article
Kit avec collant et biadhésif pour un article
Klebekit ist ein beidseitiger Klebestreifen
Возможность установки на клей.Відгеш

•08 € 4,80

**VE 13**

Porta accappatoio
Robe hook
Porte peignoir
Bademantelhaken
Крючок
cm 2 L x 4 P x 2 H

•08 € 20,00

**VE 13.3**

Porta accappatoio (3 ganci)
Robe hook (3 hooks)
Porte peignoir (3 crochets)
Bademantelhaken (3 Haken)
Крючок тройной
cm 15 L x 4 P x 2 H

•08 € 60,00

**LZ 11**

Porta rotolo
Paper holder
Porte rouleau
Papierrollenhalter
Бумагодержатель
cm 19 L x 8 P x 5 H

•08 € 39,00

**LZ 11 C**

Porta rotolo coperto
Covered paper holder
Porte rouleau avec couvercle
Papierrollenhalter mit Deckel
Бумагодержатель с крышкой
cm 14 L x 12 P x 13 H

•08 € 79,00

OPZIONI E COMPLEMENTI / OPTIONS AND COMPLEMENTS / OPTIONS ET COMPLÉMENTS / OPTIONEN UND ERGÄNZUNGEN / варианты и дополнения

Reversibile su richiesta / Reversible on request / Réversible sur demande / Umkehrbar auf Anfrage / Реверсивный по запросу

**Su richiesta si realizzano aste porta asciugamani su misura, 20 gg**

Customized towel rails are available on request, 20 days
Des porte-serviettes personnalisés sont disponibles sur demande, 20 jours
Handtuchhalter sind auf Anfrage erhältlich, 20 tagen
По запросу мы можем производить полотенцедержатели под размер 20 дней

•08 25 → 45 cm € 76,00

•08 47 → 100 cm € 86,00



> pag. 289



> pag. 366



> pag. 366



> pag. 366



> pag. 366





EASY

Designer: STILHAUS

Materiale: ottone, tondino Ø 8, basetta a muro Ø 40
Accessori: vetro satinato
Finiture: 08, 23
Fuori misura: No
Incollo: Si

Material: brass, rod diameter Ø 8, wall baseplate diameter Ø 40
Accessories: satin glass
Finishes: 08, 23
Custom size: No
Glued: Yes

Matériau : laiton, tige Ø 8, plaque murale Ø 40
Accessoires : verre satiné
Finitions : 08, 23
Sur mesure : Non
Collé : Oui

Material: Messing, Stabdurchmesser Ø 8, Wandgrundplatte Durchmesser Ø 40
Zubehör: Satin-Glas
Endbearbeitungen: 08, 23
Maßgeschneidert: Nein
Verklebt: Ja

Материал: латунь, стержень диаметром Ø 8, основание на стену диаметром Ø 40
Аксессуары: матовое стекло
Отделка: 08, 23
Нестандартный размер: Нет
Клеить: Да

EASY

ES 30 08
ES 10 08



ES 45 23



EASY

ES 11 L 23





ES 05
Asta porta salviette
Towel rail
Porte serviettes
Handtuchhalter
Полотенцедержатель
cm 60 L x 4 H x 6 P

• 08 - 23 € 49,00



ES 45
Asta porta salviette
Towel rail
Porte serviettes
Handtuchhalter
Полотенцедержатель
cm 45 L x 4 H x 6 P

• 08 - 23 € 46,00



ES 06
Asta porta salviette
Towel rail
Porte serviettes
Handtuchhalter
Полотенцедержатель
cm 30 L x 4 H x 6 P

• 08 - 23 € 39,00



ES 09
Porta sapone a parete
Wall ceramic soap dish
Porte savon en céramique
Seifenschale wandhängend
Настенная керамическая мыльница
cm 12 L x 12 P x 8 H

• 08 - 23 € 35,00



ES 10
Porta bicchiere a parete
Wall tooth brush holder
Porte verre en céramique
Zahnbürstenhalter wandhängend
Настенный керамический стакан
cm 7 L x 10 P x 9 H

• 08 - 23 € 35,00



ES 30
Dosatore sapone a parete
Wall liquid soap dispenser holder
Doseur de savon liquid en céramique
Seifenspender
Настенный керамический дозатор
cm 5 L x 9 P x 18 H

• 08 - 23 € 67,00



ES 11 L
Porta rotolo
Paper holder
Porte rouleau
Papierrollenhalter
Бумагодержатель
cm 12 L x 6 P x 4 H

• 08 - 23 € 33,00



ES 11
Porta rotolo
Paper holder
Porte rouleau
Papierrollenhalter
Бумагодержатель
cm 4 L x 12 P x 4 H

• 08 - 23 € 29,00

ES 11 23



ES 13
Porta accappatoio
Robe hook
Porte peignoir
Bademantelhaken
Крючок
cm 4 L x 3.5 P x 4 H

• 08 - 23 € 22,00



995
Porta scopino da appoggio
Toilet-brush with base
Porte balayent d'appui
Bürstengarnitur freistehend
Напольный металлический ёрш
cm 9 x 43 H

• 08 - 23 € 45,00



1946
Porta scopino a parete
Wall ceramic toilet brush
Porte balayent à mur
Bürstengarnitur wandhängend
Настенный металлический ёрш
cm 6.5 L x 8 P x 32 H

• 08 - 23 € 72,00



840 E
Kit collante e biadesivo per un articolo Easy
Kit with bi-adhesive and glue for one article
Kit avec collant et biadhésif pour un article
Klebekit ist ein beidseitiger Klebestreifen
Клей

• € 4,80



EASY5M

KIT 5pezzi: asta cm 45, porta rotolo, n. 2 porta accappatoio, scopino 1946.
5-piece set: 45 cm rod, toilet roll holder, 2 bathrobe hooks, 1946 toilet brush.
Ensemble de 5 pièces : tige de 45 cm, porte-rouleau de papier toilette, 2 crochets pour peignoir, brosse de toilette 1946.
5-teiliges Set: 45 cm Stange, Toilettenpapierhalter, 2 Bademantelhaken, WC-Bürste 1946.
Набор из 5 предметов: стержень длиной 45 см, держатель для туалетной бумаги, 2 крючка для халата, щетка для унитаза 1946 года.

€ 190,00

EASY5B

KIT 5 pezzi: asta cm 45, porta rotolo, n. 2 porta accappatoio, scopino 995.
5-piece set: 45 cm rod, toilet roll holder, 2 bathrobe hooks, 995 toilet brush.
Ensemble de 5 pièces : tige de 45 cm, porte-rouleau de papier toilette, 2 crochets pour peignoir, brosse de toilette 995.
5-teiliges Set: 45 cm Stange, Toilettenpapierhalter, 2 Bademantelhaken, WC-Bürste 995.
Набор из 5 предметов: стержень длиной 45 см, держатель для туалетной бумаги, 2 крючка для халата, щетка для унитаза 995 года.

€ 165,00

OPZIONI E COMPLEMENTI / OPTIONS AND COMPLEMENTS / OPTIONS ET COMPLÉMENTS / OPTIONEN UND ERGÄNZUNGEN / варианты и дополнения



08



CROMO
Chrome
Chrome
Chrom
хром

23



NERO OPACO
Matt black
Noir opaque
Mattschwarz
черный матовый



MIZAR

Designer: STILHAUS

Materiale: Piatto ottone 15 x 4
Accessori: ceramica bianca
Finiture: 08 - 23
Fuori misura: no

Material: Solid Brass 15x4
Accessories: white ceramic
Finishes: 08 - 23
Customized: no

Matériel: Laiton massif 15x4
Accessoires: blanc céramique
Finitions: 08 - 23
Personnalisé: No

Material: Messing bar 15 x 4
Zubehör: weiße Keramik
Ausführungen: 08 - 23
Kundenwunsch: Nein

Материал: латунь
Аксессуары: белая керамика
Покрытие: 08 - 23
Негабаритный: нет

MIZAR

MZ 09 08
MZ 10 08
MZ 30 08



MIZAR

MZ 05 23



MZ 69 08



MZ 11 23





MZ 04

Mensola plexiglass
Shelf
Etagère
Ablage
Полка из оргстекла
cm 60 L x 11 P x 5 H - INT. 59

• 08 - 23 € 110,00



MZ 05

Asta porta asciugamani
Towel rail
Porte serviettes
Handtuchhalter
Полотенцедержатель
cm 58 L x 8,5 P x 1,5 H - INT. 53

• 08 - 23 € 80,00



MZ 45

Asta porta asciugamani
Towel rail
Porte serviettes
Handtuchhalter
Полотенцедержатель
cm 45 L x 8 P x 1,5 H - INT. 39

• 08 - 23 € 62,00



MZ 06

Asta porta salviette
Towel rail
Porte serviettes
Handtuchhalter
Полотенцедержатель
cm 28,5 L x 8 P x 1,5 H - INT. 22,5

• 08 - 23 € 60,00



MZ 11

Porta rotolo
Peper holder
Porte rouleau
Papierrollenhalter
Бумагодержатель
cm 17 L x 8 P x 1,5 H

• 08 - 23 € 44,00



MZ 11C

Porta rotolo con coperchio
Covered paper holder
Porte rouleau avec couvercle
Papierrollenhalter mit Deckel
Бумагодержатель закрытый
cm 17 L x 9 P x 10 H

• 08 - 23 € 75,00



MZ 039

Porta scopino da appoggio
Toilet-brush with base
Porte balayent d'appui
Bürstengarnitur freistehend
Напольный металлический ёрш
cm Ø 8 x 44 H

• 08 - 23 € 97,00



MZ 039 M

Porta scopino a parete
Wall-mounted toilet-brush
Porte balayent à mur
Bürstengarnitur oval wandhängend
Настенный металлический ёрш
cm Ø 8 x 44 H

• 08 - 23 € 105,00



MZ 06.1

Asta porta salviette
Towel rail
Porte serviettes
Handtuchhalter
Полотенцедержатель
cm 27 L x 8 P x 1,5 H

• 08 - 23 € 57,00



MZ 69

Porta salviette con porta sapone
Serviettes holder with soap dish
Porte serviettes avec porte savon
Handtuchhalter mit Seifenschale
Полотенцедержатель + керамическая
мыльница
cm 29 L x 8 P x 4 H

• 08 - 23 € 83,00



MZ 69 D

Porta salviette con dosatore sapone
Serviettes holder with soap dispenser
Porte serviettes avec doseur de savon
Handtuchhalter mit Seifenspender
Полотенцедержатель + керамический дозатор
cm 27 L x 8 P x 18 H

• 08 - 23 € 115,00



MZ 09

Porta sapone a parete
Wall mounted ceramic soap dish
Porte savon à mur en céramique
Seifenschale wandhängend aus Keramik
Настенная керамическая мыльница
cm 11,5 L x 7 P x 4 H

• 08 - 23 € 61,00



1076

Mensola plexiglass con asta porta asciugamani
Shelf with towel rail
Entragerè avec porte serviettes
Ablage mit Handtuchhalter
Полка из оргстекла с полотенцедержателем
cm 26 L x 11 P x 13 H - INT. 24,5

• 08 - 23 € 149,00



1077

Mensola plexiglass con asta porta asciugamani
Shelf with towel rail
Entragerè avec porte serviettes
Ablage mit Handtuchhalter
Полка из оргстекла с полотенцедержателем
cm 40 L x 11 P x 13 H - INT. 28,5

• 08 - 23 € 189,00



OPZIONI E COMPLEMENTI / OPTIONS AND COMPLEMENTS / OPTIONS ET COMPLÉMENTS / OPTIONEN UND ERGÄNZUNGEN / варианты и дополнения



08

CROMO
Chrome
Chrome
Chrom
хром



23

NERO OPACO
Matt black
Noir opaque
Matt schwarz
черный матовый



Reversibile su richiesta
Reversible on request / Réversible sur demande / Umkehrbar auf Anfrage / Реверсивный по запросу



MZ 10

Porta bicchiere a parete
Wall mounted ceramic glass holder
Porte verre à mur en céramique
Zahnbürstenhalter wandhängend aus Keramik
Настенный керамический стакан
cm 8 L x 8 P x 12 H

• 08 - 23 € 65,00



MZ 30

Porta dosatore sapone liquido in ceramica
Ceramic liquid soap dispenser holder
Doseur de savon liquid en céramique
Seifenspender aus Keramik
Настенный керамический дозатор
cm 8 L x 8 P x 18 H

• 08 - 23 € 83,00



MZ 14

Porta sapone con Porta bicchiere
Soap dish + Glass holder
Porte savon + Porte verre
Seifenschale + Zahnbürstenhalter freistehend
Настольные керамический
cm 16 L x 8 P x 18 H

• 08 - 23 € 130,00



MZ 13.2

Porta accappatoio (2 ganci)
Robe hook (2 hooks)
Porte peignoir (2 crochets)
Bademantelhaken (2 Haken)
Крючок
cm 2 L x 3,5 P x 9 H

• 08 - 23 € 40,00



> pag. 265

> pag. 324

> pag. 449

> pag. 449

> pag. 448

> pag. 448



TOTEM

Designer: MASSIMILIANO SETTIMELLI

Materiale: Ottone
Accessori: Ocritch, Plexiglass trasparente
Finitura: 08 - 03 - 05 - 36
Fuori misura: Si
Certificazione: UNI EN 11064/2019

Material: Brass
Accessories: Ocritch, Plexiglas transparent
Finishes: 08 - 03 - 05 - 36
Customized: Yes
Certification: UNI EN 11064/2019

Matériel: Laiton
Accessoires: céramique
Finitions: 08 - 03 - 05 - 36
Personnalisé: Oui
Certification : UNI EN 11064/2019

Material: Messing
Zubehör: Ocritch, klares Plexiglas
Ausführungen: 08 - 03 - 05 - 36
Kundenwunsch: Ja
Zertifizierung: UNI EN 11064/2019

Материал: латунь
Аксессуары: Окритч, прозрачное оргстекло
Отделка: 08 - 03 - 05 - 36
Негабаритный: да
Сертификация: UNI EN 11064/2019

TT 03 08
TT 15
TT 1205 + TT 1206



TT 1206
TT 14
TT 02 05



TT 1108



TT 0103





TT 01

Maniglione di sicurezza in ottone cm 30
Brass safety handle cm 30
Poignée de sécurité en laiton cm 30
Sicherheitsgriff aus Messing cm 30
Латунная предохранительная ручка см 30
cm 35,5 L x 8 P x 3 H - INT. 29

• 08 - 03 - 05	€ 94,00
• 36	€ 115,00



TT 02

Maniglione di sicurezza in ottone cm 45
Brass safety handle cm 45
Poignée de sécurité en laiton cm 45
Sicherheitsgriff aus Messing cm 45
Латунная предохранительная ручка см 45
cm 45,5 L x 8 P x 3 H - INT. 39

• 08 - 03 - 05	€ 100,00
• 36	€ 125,00



TT 03

Maniglione di sicurezza in ottone cm 60
Brass safety handle cm 60
Poignée de sécurité en laiton cm 60
Sicherheitsgriff aus Messing cm 60
Латунная предохранительная ручка см 60
cm 60,5 L x 8 P x 3 H - INT. 54

• 08 - 03 - 05	€ 110,00
• 36	€ 138,00



TT 04

Maniglione di sicurezza in ottone cm 80
Brass safety handle cm 80
Poignée de sécurité en laiton cm 80
Sicherheitsgriff aus Messing cm 80
Латунная предохранительная ручка см 80
cm 80,5 L x 8 P x 3 H - INT. 74

• 08 - 03 - 05	€ 125,00
• 36	€ 155,00



TT 09

Maniglione di sicurezza in ottone cm 120
Brass safety handle cm 120
Poignée de sécurité en laiton cm 120
Sicherheitsgriff aus Messing cm 120
Латунная предохранительная ручка см 120
cm 120,9 L x 8,5 P x 3 H

• 08 - 03 - 05	€ 200,00
• 36	€ 250,00



TT 12

Vaschetta plexiglass per barra orizzontale
Plexiglas tray for horizontal bar
Plateau en plexiglas pour barre horizontale
Plexiglasschale für horizontale Stange
Лоток из оргстекла для горизонтальной полосы
cm 25 L x 14 P x 12 H

•	€ 42,00
---	---------



TT 14

Mensola 1 foro plexiglass per barra orizzontale
Plexiglass shelf 1 hole for horizontal bar
Étagère en plexiglas 1 trou pour barre horizontale
Plexiglasboden 1 Loch für Reckstange
Полка из оргстекла 1 отверстие для горизонтальной штанги
cm 10 L x 14 P x 6 H

•	€ 38,00
---	---------



TT 15

Mensola 2 fori plexiglass per barra orizzontale
2-hole plexiglass shelf for horizontal bar
Tablette en plexiglas à 2 trous pour barre horizontale
2-Loch-Plexiglasablage für Reckstange
Полка из оргстекла с 2 отверстиями для горизонтальной штанги
cm 25 L x 14 P x 6 H

•	€ 42,00
---	---------



TT 11

Porta rotolo con calamita
Roll holder with magnet
Porte-rouleau avec aimant
Rollenhalter mit Magnet
Держатель рулона с магнитом
cm 12 L x 13 P x 12 H

• 08 - 03 - 05	€ 84,00
• 36	€ 105,00



TT 1205

Bicchiere in Neolite per Totem
Neolite glass for Totem
Verre de néolite pour Totem
Neolithglas für Totem
Неолитовое стекло для Тотема
cm Ø 7,5 x 13 H

• BI	€ 88,00
• NE	€ 99,00



TT 1206

Dosatore in Neolite per Totem
Neolite dispenser for Totem
Distributeur de néolite pour Totem
Neolith-Spender für Totem
Неолитовый дозатор для Тотема
cm Ø 7,5 x 17 H

• BI / 08 - 03 - 05	€ 148,00
• BI / 36	€ 175,00
• NE / 08 - 03 - 05	€ 158,00
• NE / 36	€ 185,00



LZ 13

Porta accappatoio
Robe hook
Porte peignoir
Bademantelhaken
Крючок
cm 2 P x 5 L x 5 H

• 08 - 03 - 05	€ 29,00
• 36	€ 38,00

Certificazione: UNI EN 11064/2019

Certificazione: UNI EN 11064/2019

TT47 08 + TT50 + TT12



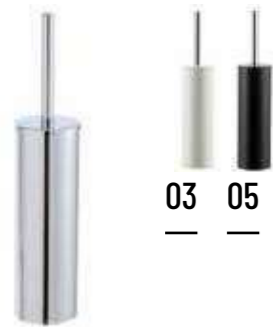

03 05

TT 039

Porta scopino da appoggio
Toilet-brush with base
Porte balayent d'appui
Bürstengarnitur freistehend
Напольный металлический ёрш
cm Ø 8 x 40,5 H

• 08 - 03 - 05	€ 89,00
• 36	€ 110,00

TT 039 M

Porta scopino a parete
Wall-mounted toilet-brush
Porte balayent à mur
Bürstengarnitur oval wandhängend
Настенный металлический ёрш
cm Ø 8 x 40,5 H

• 08 - 03 - 05	€ 98,00
• 36	€ 120,00

TT 05

Asta per connessione a "T" cm 30
Rod for "T" connection cm 30
Tige pour raccord en "T" cm 30
Stange für "T"-Verbindung cm 30
Стержень для "T" соединения cm 30
cm 38,5 L x 8,5 P x 3,5 H

• 08 - 03 - 05	€ 128,00
• 36	€ 160,00

TT 06

Asta per connessione a "T" cm 45
Rod for "T" connection cm 45
Tige pour raccord en "T" cm 45
Stange für "T"-Verbindung cm 45
Стержень для "T" соединения cm 45
cm 48,5 L x 8,5 P x 3,5 H

• 08 - 03 - 05	€ 135,00
• 36	€ 169,00



TT 07

Asta per connessione a "T" cm 60
Rod for "T" connection cm 60
Tige pour raccord en "T" cm 60
Stange für "T"-Verbindung cm 60
Стержень для "T" соединения cm 60
cm 63,5 L x 8,5 P x 3,5 H

• 08 - 03 - 05	€ 142,00
• 36	€ 185,00



TT 08

Asta per connessione a "T" cm 80
Rod for "T" connection cm 80
Tige pour raccord en "T" cm 80
Stange für "T"-Verbindung cm 80
Стержень для "T" соединения cm 80
cm 83,5 L x 8,5 P x 3,5 H

• 08 - 03 - 05	€ 170,00
• 36	€ 210,00



TT 46

Maniglione ad "L"
L-shaped handle
Poignée en forme de L
L-förmiger Griff
Г-образная ручка
cm 45 L x 8 P x 80 H

• 08 - 03 - 05	€ 255,00
• 36	€ 315,00



TT 47

Maniglione ad "L"
L-shaped handle
Poignée en forme de L
L-förmiger Griff
Г-образная ручка
cm 60 L x 8 P x 80 H

• 08 - 03 - 05	€ 265,00
• 36	€ 325,00



TT 48

Maniglione ad "L"
L-shaped handle
Poignée en forme de L
L-förmiger Griff
Г-образная ручка
cm 80 L x 8 P x 80 H

• 08 - 03 - 05	€ 290,00
• 36	€ 360,00



TT 49

Maniglione ad angolo
Corner handle
Poignée d'angle
Eckgriff
Угловая ручка
cm 60 L x 8 P x 60 H

• 08 - 03 - 05	€ 255,00
• 36	€ 315,00



TT 50

Doccetta completa di supporto e tubo
Shower complete with stand and hose
Douche complète avec support et tuyau
Dusche komplett mit Ständer und Schlauch
Душ в комплекте со стойкой и шлангом
cm 120,9 L x 4 P x 5 H

• 08 - 03 - 05	€ 75,00
• 36	€ 115,00



TT 51

Porta accappatoio per barra
Bathrobe holder for bar
Support de peignoir pour le bar
Bademantelhalter für Stange
Держатель банного халата для барной стойки
cm 6,5 L x 4 P x 5 H

• 08 - 03 - 05	€ 37,00
• 36	€ 48,00

Certificazione: UNI EN 11064/2019

TT 47 08 + TT 50



TT 09 03 + TT 06 03



Certificazione: UNI EN 11064/2019

TT 49 08

OPZIONI E COMPLEMENTI / OPTIONS AND COMPLEMENTS / OPTIONS ET COMPLÉMENTS / OPTIONEN UND ERGÄNZUNGEN / варианты и дополнения



08

CROMO
Chrome
Chrome
Chrom
хром



03

CROMO + BIANCO
Chrome - White
Chrome - Blanc
Chrom - Weiß
хром - белый



05

CROMO + NERO OPACO
Chrome - Matt black
Chrome - Noir mat
Chrom - Mattschwarz
Хром - матовый черный



36

NICHEL SATINATO
Satin nickel
Nickel satiné
Nickel satiniert
Никель сатин

Struttura porta lavabo con porta asciugamani
Support with towelholder
Structure avec porte serviette
Struktur mit Handtuchhalter
Структура с полотенцем

TT 1280 cm 50 L x 40 P x 74 H	
• 08 - 03 - 05	€ 440,00
• 36	€ 550,00
TT 1280/60 cm 60 L x 40 P x 74 H	
• 08 - 03 - 05	€ 480,00
• 36	€ 590,00

1282

Lavabo in ceramica
Ceramic washbasin
Lavabo en céramique
Keramik Aufsatzwaschbecken
Керамическая раковина

1282 cm 50 L x 41 P x 14 H	
• 01	€ 400,00
1282/60 cm 60 L x 41 P x 14 H	
• 01	€ 440,00

TT 04

Maniglione di sicurezza in ottone cm 80
Brass safety handle cm 80
Poignée de sécurité en laiton cm 80
Sicherheitsgriff aus Messing cm 80
Латунная предохранительная ручка см 80
cm 80,5 L x 8 P x 3 H

• 08	€ 125,00
------	----------

TT 15

Mensola 2 fori plexiglass per barra orizzontale
2-hole plexiglass shelf for horizontal bar
Tablette en plexiglas à 2 trous pour barre horizontale
2-Loch-Plexiglasablage für Reckstange
Полка из оргстекла с 2 отверстиями для горизонтальной штанги
cm 20 L x 14 P x 6 H

•	€ 42,00
---	---------

TT 1205

Bicchieri in Neolite per Totem
Neolite glass for Totem
Verre de néolite pour Totem
Neolithglas für Totem
Неолитовое стекло для Тотема
cm Ø 7,5 x 13 H

• BI	€ 88,00
------	---------

TT 1206

Dosatore in Neolite per Totem
Neolite dispenser for Totem
Distributeur de néolite pour Totem
Neolith-Spender für Totem
Неолитовый дозатор для Totem
cm Ø 7,5 x 17 H

• BI - 08	€ 148,00
-----------	----------



Struttura porta lavabo in ottone con mensola in vetro
Brass support with glass shelf
Support avec glass étagère
Waschtischkonsole aus Messing mit Glasablage
Каркас из хромированной латуни со стеклянной полкой

TT 1281 cm 50 L x 41 P x 74 H	
• 08 - 03 - 05	€ 690,00
• 36	€ 790,00
TT 1281/60 cm 60 L x 41 P x 74 H	
• 08 - 03 - 05	€ 780,00
• 36	€ 860,00

1282

Lavabo in ceramica
Ceramic washbasin
Lavabo en céramique
Keramik Aufsatzwaschbecken
Керамическая раковина
cm 50 L x 41 P x 14 H

1282 cm 50 L x 41 P x 14 H	
• 01	€ 400,00
1282/60 cm 60 L x 41 P x 14 H	
• 01	€ 440,00

TT 1283

Maniglione di sicurezza reclinabile
Brass safety handle cm 80
Poignée de sécurité en laiton cm 80
Sicherheitsgriff aus Messing cm 80
Латунная предохранительная ручка см 80
cm 80,5 L x 8 P x 3 H

• 08	€ 280,00
------	----------

TT 03

Maniglione di sicurezza in ottone cm 60
Brass safety handle cm 60
Poignée de sécurité en laiton cm 60
Sicherheitsgriff aus Messing cm 60
Латунная предохранительная ручка см 60
cm 60,5 L x 8 P x 3 H

• 08	€ 110,00
------	----------

TT 14

Mensola 1 foro plexiglass per barra orizzontale
Plexiglass shelf 1 hole for horizontal bar
Étagère en plexiglas 1 trou pour barre horizontale
Plexiglasboden 1 Loch für Reckstange
Полка из оргстекла 1 отверстие для горизонтальной штанги
cm 10 L x 14 P x 6 H

•	€ 38,00
---	---------

TT 1206

Dosatore in Neolite per Totem
Neolite dispenser for Totem
Distributeur de néolite pour Totem
Neolith-Spender für Totem
Неолитовый дозатор для Totem
cm Ø 7,5 x 17 H

• NE - 08	€ 158,00
-----------	----------



KREA

Designer: PAOLO GALLETI E DANIELE MALTINTI

Materiale: Piatto inox 304
Accessori: Ceramica bianca
Finiture: 54 - 23
Combinazioni: 4000
Modello registrato N. 402017000142123

Material: Inox 304
Accessories: White ceramic
Finishes: 54 - 23
Combinations: 4000
European patent model No.402017000142123

Matériel: Inox 304
Accessoires: Blanc céramique
Finitions: 54 - 23
Combinaisons: 4000
Brevet Européen modèl No. 402017000142123

Material: Inox 304
Zubehör: Weiße keramik
Ausführungen: 54 - 23
Kombinationen: 4000
Europäisches Patent modell Nr. 402017000142123

Материал: латунь 30x20
Аксессуары: белая керамика
Отделка: 54 - 23
комбинации: 4000
европейский патент модель No 402017000142123

KREA

SOL 1 54



KREA

SOL 2 54



SOL 3 23





KR 00

Attacco a parete
Bracket for wall
Support mural
Wandhalterung
крепление к стене
cm Ø 7

• 54 - 23 € 45,00



KR 01

Finale
Final part
Partie finale
Abschlussenteil
наконечники
cm Ø 4 x 2 P

• 54 - 23 € 34,00



KR 06

Asta 28
Tower rail
Porte serviettes
Handtuchhalter
Полотенцедержатель
cm 40 L x 7,5 H

• 54 - 23 € 50,00



KR 09

Porta sapone
Soap dish
Porte savon
Seifenschale
Настенная керамическая мыльница
cm 17 L x 13 P x 15 H

• 54 - 23 € 65,00



KR 10

Porta bicchiere
Glass
Verre
Zahnputzbecher
Настенный керамический стакан
cm 13 L x 6 P x 19 H

• 54 - 23 € 65,00



KR 30

Dosatore sapone liquido
Liquid soap dispenser
Porte savon liquid
Seifenspender
Настенный керамический дозатор
cm 13 L x 11 P x 21 H

• 54 - 23 € 95,00



KR 08

Mensola porta oggetti
Shelf
Étagère portant des objets
Regal
полка для настольных предметов
cm 19 L x 11 P x 17 H

• 54 - 23 € 65,00



KR 13 P

Porta accappatoio corto
Robe hook
Porte peignoir
Bademantelhaken
Крючок
cm 15 L x 4 P x 8 H

• 54 - 23 € 37,00



KR 13 G

Porta accappatoio lungo
Robe hook
Porte peignoir
Bademantelhaken
Крючок
cm 27 L x 4 P x 8 H

• 54 - 23 € 42,00



KR 11

Porta rotolo
Paper holder
Porte rouleau
Papierrollenhalter
Бумагодержатель
cm 18 L x 8 P x 7,5 H

• 54 - 23 € 40,00



KR 039 M

Porta scopino a parete
Wall mounted toilet-brush
Porte balaynet à mur
Bürstengarnitur wandhängend
Настенный металлический ёрш
cm 8 L x 8,5 P x 56 H

• 54 - 23 € 125,00





SOL 01
• 54 - 23 € 359,00



SOL 2
• 54 - 23 € 239,00



SOL 3
• 54 - 23 € 264,00



SOL 4
• 54 - 23 € 349,00



SOL 5
• 54 - 23 € 299,00

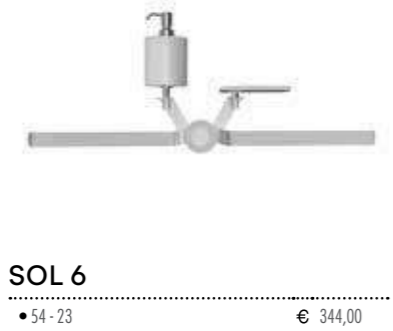

SOL 6
• 54 - 23 € 344,00



SOL 7
• 54 - 23 € 294,00

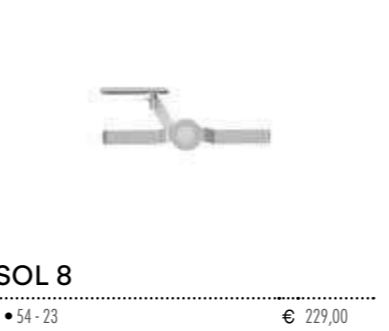

SOL 8
• 54 - 23 € 229,00

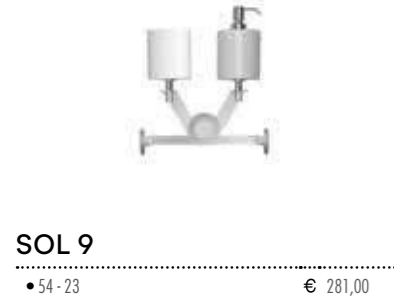

SOL 9
• 54 - 23 € 281,00



SOL 10
• 54 - 23 € 236,00



SOL 11
• 54 - 23 € 339,00



SOL 12
• 54 - 23 € 309,00



SOL 13
• 54 - 23 € 274,00



SOL 14
• 54 - 23 € 284,00



SOL 15
• 54 - 23 € 389,00



SOL 16
• 54 - 23 € 244,00



SOL 17
• 54 - 23 € 161,00



CONFIGURA LA TUA KREA CON LA NOSTRA APP

Configure your Krea with our App
Configurez votre Krea avec notre application
Konfigurieren sie ihr Krea mit unserer App
Настройте свой KREA с нашим APP

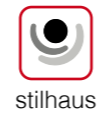

SOL 5



SOL 6



SOL 7



SOL 8



SOL 9



SOL 10



SOL 11



SOL 12



SOL 13



SOL 14



SOL 15



SOL 16

SOL 17 54



KR DEC 1

Decoro
Decorum
Decorum
Dekor-Rosette
декор
cm Ø 20

- BI - NE - BL - VE - RO - AR € 28,00
- LG € 42,00



BI NE BL VE



KR DEC 2

Decoro
Decorum
Decorum
Dekor-Rosette
декор
cm 20 L x 20 H

- BI - NE € 28,00
- LG € 42,00



BI NE LG



KR DEC 3

Decoro
Decorum
Decorum
Dekor-Rosette
декор
cm 30 L x 20 H

- BI - NE € 33,00
- LG € 54,00



BI NE LG

ESEMPIO
EXAMPLE
EXEMPLE
BEISPIEL
Пример



A	KR 00 + KR 01	KR DEC 1 + KR 10 + KR 30 + KR 06	€ 317,00
B	KR 00 + KR 01	KR DEC 2 + KR 30 + KR 10 + KR 13 G	€ 309,00
C	KR 00 + KR 01	KR 11 + KR 039	€ 244,00

SCHEMA DI MONTAGGIO

Assembly scheme / Schéma d'assemblage / Montageschema / Схема сборки



KREA: Modello registrato N. 402017000142123
KREA: European patent model N.402017000142123
KREA: Brevet Européen modèle N. 402017000142123
KREA: Europäisches Patent modell Nr. 402017000142123
KREA: KREA: Европейский патент модель No 402017000142123

OPZIONI E COMPLEMENTI / OPTIONS AND COMPLEMENTS / OPTIONS ET COMPLÉMENTS / OPTIONEN UND ERGÄNZUNGEN / варианты и дополнения



54

ACCIAIO SATINATO
Satin steel
Acier satiné
Stahl satiniert
сатинованная сталь

23

NERO OPACO
Matt black
Noir opaque
Mattschwarz
черный матовый



ELITE

Designer: STILHAUS

Materiale: ottone, Tubo ø 16, basetta a muro ø 63
Accessori: Vetro satinato
Finitura: 08-02-16-25-26-36
Fuori misura: Si
Incollo: Si

Material: Brass tube ø 16, fixing plate cover ø 63
Accessories: Frosted glass
Finishes: 08-02-16-25-26-36
Customized: Yes
By glue : Yes

Matière: Laiton, tuyau ø 16, boucle couvre-vis ø 63
Accessoires: Verre satin
Finitions: 08-02-16-25-26-36
Personnalisé: Oui
Par collage : Oui

Material: Messing Rohr ø 16, Befestigungsplatten Oberfläche 63
Zubehör: Mattglas
Ausführungen: 08-02-16-25-26-36
Kundenwunsch: Ja
Kleber: Ja

Материал: латунь Ø 16, Ø 63
Аксессуары: матовое стекло
Отделка: 08-02-16-25-26-36
Негабаритный: да
Установка на клей: да

ELITE

EL 45 08



ELITE

EL 69 D 08



EL 11 08



EL 07 08



ELITE

EL 06 25



ELITE

EL 11 C 16



EL 30 36



EL 13 27





EL 04

Mensola vetro 8mm
Shelf
Étagère
Ablage
Стеклоплатформа - толщина стекла 8 мм
cm 70 L x 13 P x 6 H x 61,5 INT

• 08	€ 180,00
• 02	€ 208,00
• 16-25-26-27-36	€ 245,00



EL 33

Mensola + porta asciugamani
Shelf + towel rail
Étagère + porte serviette
Ablage + Handtuchhalter
Стеклоплатформа + полотенцедержатель
cm 61 L x 15 P x 7 H x 51 INT

• 08	€ 240,00
• 02	€ 265,00
• 16-25-26-27-36	€ 325,00



EL 05

Asta porta asciugamani
Towel rail
Porte serviette
Handtuchhalter
Полотенцедержатель
cm 61 L x 9 P x 6 H x 51 INT

• 08	€ 130,00
• 02	€ 155,00
• 16-25-26-27-36	€ 179,00



EL 05.2

Porta asciugamani doppia asta
Towel rail with 2 bars
Porte serviette avec 2 barres
Handtuchhalter schwenkbar 2 Stangen
Полотенцедержатель двойной
cm 61 L x 14 P x 7 H x 51 INT

• 08	€ 199,00
• 02	€ 235,00
• 16-25-26-27-36	€ 270,00



EL 45

Asta porta asciugamani
Towel rail
Porte serviette
Handtuchhalter
Полотенцедержатель
cm 50 L x 9 P x 6 H x 40 INT

• 08	€ 125,00
• 02	€ 145,00
• 16-25-26-27-36	€ 178,00



EL 06

Asta porta salviette
Towel rail
Porte serviettes
Handtuchhalter
Полотенцедержатель
cm 42 L x 9 P x 6 H x 31,5 INT

• 08	€ 118,00
• 02	€ 135,00
• 16-25-26-27-36	€ 168,00



EL 16

Porta asciugamani snodo 2 aste
Towel rail with 2 adjustable bar
Porte serviettes à 2 barres orientables
Handtuchhalter schwenkbar 2 Stangen
Полотенцедержатель двойной поворотный
cm 38 L x 9/43 P x 16 H

• 08	€ 145,00
• 02	€ 160,00
• 16-25-26-27-36	€ 205,00



EL 69

Porta salviette con porta sapone
Towel rail with soap dish
Porte serviettes avec porte savon
Handtuchhalter mit Seifenschale
Полотенцедержатель + стеклянная мыльница
cm 52 L x 12 P x 6 H x 40 INT

• 08	€ 139,00
• 02	€ 146,00
• 16-25-26-27-36	€ 195,00



EL 69 D

Porta salviette con dosatore sapone
Towel rail with soap dispenser
Porte serviettes avec porte savon liquid
Handtuchhalter mit Seifenspender
Полотенцедержатель + стеклянный дозатор
cm 50 L x 9 P x 6 H x 40 INT

• 08	€ 170,00
• 02	€ 185,00
• 16-25-26-27-36	€ 235,00



EL 07

Anello porta salviette
Ring serviette holder
Porte serviettes à anneau
Handtuchring
Полотенцедержатель - полукольцо
cm 30 L x 9 P x 15 H

• 08	€ 100,00
• 02	€ 122,00
• 16-25-26-27-36	€ 145,00



EL 79

Anello porta salviette con porta sapone
Ring serviette holder with soap holder
Porte serviettes à anneau avec porte savon
Handtuchring mit Seifenschale
Полотенцедержатель - полукольцо +
стеклянная мыльница
cm 30 L x 10 P x 16 H

• 08	€ 155,00
• 02	€ 168,00
• 16-25-26-27-36	€ 210,00



EL 79 D

Anello porta salviette con dosatore sapone
Ring serviette holder with soap dispenser
Porte serviettes à anneau avec porte savon liquid
Handtuchring mit Seifenspender
Полотенцедержатель - полукольцо +
стеклянный дозатор
cm 30 L x 9 P x 22 H

• 08	€ 187,00
• 02	€ 200,00
• 16-25-26-27-36	€ 250,00

O 01

Specchio ovale molato
Cut ovale mirror with grind
Miroir ovale coupé avec meulage
Ovaler Spiegel mit Facettenschliff
Овальное зеркало
cm 65 x 90

€ 270,00

EL 03.2 ELITE

Appliche doppia, paralume P
Appliche with 2 lamps, lampshade P
Applique avec 2 lampe, abat-jour P
Wandleuchte doppelt, Lampenglass P
Настенные 2 лампы с абажуром
cm 36 L x 15 P x 16 H

CE : V 220 IP 20 40 Wx2

• 08	€ 210,00
• 02	€ 235,00
• 16-25-26	€ 275,00

1047

Struttura porta lavabo in ottone con mensola
in vetro
Brass support with glass shelf
Support avec glass étagère
Waschtischkonsole aus Messing mit Glasablage
Каркас из хромированной латуни со
стеклянной полкой
cm 100 L x 46 P x 82 H

• 08 € 1.180,00

1048

Lavabo in ceramica in stile
Ceramic washbasin
Lavabo en céramique
Waschtisch aus Keramik im klassischen Stil
Керамическая раковина
cm 102 L x 62 P x 17 H

• 01 € 760,00

RAC 393

Sifone tornito in ottone cromato 1" ¼
Chromed brass si phon 1" ¼
Siphon en laiton chromé 1" ¼
Siphon aus verchromtem Messing 1" ¼
Хромированный сифон 1" ¼

• 08	€ 86,00
• 16-25-26	€ 230,00





EL 09

Porta sapone a parete
Wall mounted soap dish
Porte savon à mur
Seifenschale wandhängend
Настенная стеклянная мыльница
cm 20 L x 11 P x 6 H

• 08	€ 90,00
• 02	€ 105,00
• 16-25-26-27-36	€ 125,00



EL 10

Porta bicchiere a parete
Wall mounted holder
Porte à mur
Zahnbürstenhalter wandhängend
Настенный стеклянный стакан
cm 8 L x 11 P x 12 H

• 08	€ 100,00
• 02	€ 115,00
• 16-25-26-27-36	€ 140,00



EL 30

Dosatore sapone liquido a parete
Wall-mounted soap dispenser
Doseur de savon
Seifenspender
Настенный стеклянный дозатор
cm 18 L x 11 P x 18 H

• 08	€ 115,00
• 02	€ 135,00
• 16-25-26-27-36	€ 165,00



EL 14

Porta sapone con porta bicchiere a parete
Wall mounted soap dish + Glass holder
Porte savon + Porte verre mural
Seifenschale + Zahnbürstenhalter wandhängend
Настенные стеклянные стакан + мыльница
cm 26 L x 11 P x 12 H

• 08	€ 180,00
• 02	€ 205,00
• 16-25-26-27-36	€ 240,00



EL 039

Porta scopino da appoggio
Toilet-brush with base
Porte balayent d'appui
Bürstengarnitur freistehend
Напольный металлический ёрш
cm 12,5 Ø x 40 H

• 08	€ 115,00
• 02	€ 120,00
• 16-25-26-27-36	€ 160,00



EL 11.11 S

Porta rotolo con scorta
Paper holder with supply
Porte rouleau avec escorte
Papierrollenhalter mit Ersatzhalter
Бумагодержатель двойной
cm 24 L x 9 P x 13 H

• 08	€ 165,00
• 02	€ 185,00
• 16-25-26-27-36	€ 220,00



EL 1016

Maniglia per box doccia
Handle for shower enclosure
Poignée pour cabinets de douche
Handgriff für Duschkabinen
Ручка для душевого угла
cm 2 L x 6 P x 26 H - INT. 14

• 08	€ 83,00
• 02	€ 88,00
• 16-25-26-27-36	€ 110,00



840

Kit collante e biadesivo per un articolo
Kit with bi-adhesive and glue for one article
Kit avec collant et biadhésif pour one article
Klebekit ist ein beidseitiger Klebestreifen
Возможность установки на клей.б\фдгрш

•	€ 4,80
---	--------



EL 09 AP

Porta sapone da appoggio
Soap dish with base
Porte savon d'appui
Seifenschale freistehend
Настольная стеклянная мыльница
cm 15 L x 14 P x 12 H

• 08	€ 78,00
• 02	€ 84,00
• 16-25-26-27-36	€ 105,00



EL 10 AP

Porta bicchiere da appoggio
Glass holder with base
Porte verre d'appui
Zahnbürstenhalter freistehend
Настольный стеклянный стакан
cm 9 L x 14 P x 12 H

• 08	€ 86,00
• 02	€ 92,00
• 16-25-26-27-36	€ 115,00



EL 30 AP

Dosatore sapone liquido da appoggio
Soap dispenser with base
Porte savon d'appui
Seifenspender freistehend
Настольный стеклянный дозатор
cm Ø 8 x 18 H

• 08	€ 103,00
• 02	€ 110,00
• 16-25-26-27-36	€ 140,00



EL 15

Porta sapone + Porta bicchiere da appoggio
Soap dish + Glass holder with base
Porte savon + Porte verre d'appui
Seifenschale + Zahnbürstenhalter freistehend
Настольные стеклянные стакан + мыльница
cm Ø 12,5 x 18 H

• 08	€ 210,00
• 02	€ 225,00
• 16-25-26-27-36	€ 295,00



08

CROMO
Chrome
Chrom
хром



36*

NICHEL SATINATO
Satin nickel
Nickel satiné
Nickel satiniert
Никель сатин



02

CROMO - ORO
Chrome - gold
Chrome - or
Chrom - Gold
Хром - золото



16

ORO
Gold
Or
Gold
Золото



25

BRONZO LUCIDO
Polish bronze
Bronze poli
Bronzepolitidch
Бронза



26*

RAME
Copper
Cuivre
Kupfer
Медь



27*

BRONZO OPACO
Matt bronze
Bronze mat
Matte bronze
Медь



FN*

PROGETTO SARTORIA
+50% DAL 08
Tailoring project
Increase +50% on 08

FN*PVD**

PROGETTO SARTORIA PVD
+80% DAL 08
Tailoring project PVD
increase +80% on 08



Reversibile su richiesta
Reversible on request
Réversible sur demande
Umkehrbar auf Anfrage
Реверсивный по запросу



EL 13

Porta accappatoio (2 ganci)
Robie hook (2 hooks)
Porte peignoir (2 peignoir)
Bademantelhaken (2 Haken)
Крючок двойной
cm 8 L x 9 P x 6 H

• 08	€ 78,00
• 02	€ 90,00
• 16-25-26-27-36	€ 108,00



EL 11

Porta rotolo
Paper holder
Porte rouleau
Papierrollenhalter
Бумагодержатель
cm 19,5 L x 9 P x 6 H

• 08	€ 81,00
• 02	€ 102,00
• 16-25-26-27-36	€ 115,00



EL 11 C

Porta rotolo coperto
Covered paper holder
Porte rouleau avec couvercle
Papierrollenhalter mit Deckel
Бумагодержатель с крышкой
cm 20,5 L x 11 P x 11 H

• 08	€ 120,00
• 02	€ 140,00
• 16-25-26-27-36	€ 165,00



EL 12

Porta scopino a parete
Wall mounted toilet brush
Porte balayette à mur
Bürstengarnitur wandhängend
Настенный стеклянный ёрш
cm 10 L x 14 P x 35 H

• 08	€ 135,00
• 02	€ 155,00
• 16-25-26-27-36	€ 189,00



> pag. 300



> pag. 334



> pag. 370



> pag. 344



> pag. 468



> pag. 474



> pag. 340





PRISMA

Designer: STILHAUS

Materiale: ottone, Tubo Ø16, basetta a muro 45x45
Accessori: Ceramica bianca o nera
Finitura: 08-16-25-36
Fuori misura: Si

Material: Brass tube Ø 16, fixing plate cover 45x45
Accessories: White or black ceramic
Finishes: 08-16-25-36
Customized: Yes

Matière: Laiton, tuyau Ø 16, boucle couvre-vis 45x45
Accessoires: Blanc or noir céramique
Finitions: 08-16-25-36
Personnalisé: Oui

Material: Messing Rohr Ø 16, Befestigungsplatten Oberfläche 45x45
Zubehör: Keramik schwarz oder weiß
Ausführungen: 08-16-25-36
Kundenwunsch: Ja

Используемый материал: латунь Ø 16, 45x45
Аксессуары: белая или черная керамика
Отделка: 08-16-25-36
Негабаритный: да

PR 18 08



PR 09 08
PR 06 08



PR 10 08
PR 30 08



PR 45 16





PR 04

Mensola vetro 8mm
Shelf
Etagère
Ablage
Стеклянная полка - толщина стекла 8mm
cm 75 L x 12 P x 4,5 H - INT. 66

• 08	€ 205,00
• 16-25-36	€ 255,00



PR 05

Asta porta asciugamani
Towel rail
Porte serviette
Handtuchhalter
Полотенцедержатель
cm 60 L x 9 P x 4,5 H - INT. 51

• 08	€ 165,00
• 16-25-36	€ 210,00



PR 05.2

Porta asciugamani doppia asta
Double towel rail
Porte serviettes avec 2 bars
Doppel Handtuchstange
Полотенцедержатель двойной
cm 60 L x 14 P x 7 H - INT. 51

• 08	€ 245,00
• 16-25-36	€ 305,00



PR 45

Asta porta asciugamani
Towel rail
Porte serviette
Handtuchhalter
Полотенцедержатель
cm 50 L x 9 P x 4,5 H - INT. 40

• 08	€ 155,00
• 16-25-36	€ 198,00



PR 06

Asta porta salviette
Towel rail
Porte serviettes
Handtuchhalter
Полотенцедержатель
cm 39 L x 9 P x 4,5 H - INT. 31,50

• 08	€ 148,00
• 16-25-36	€ 195,00



PR 16

Porta asciugamani snodo 2 aste
Towel rail with 2 adjustable bar
Porte serviettes à 2 barres orientables
Handtuchhalter schwenkbar 2 Stangen
Полотенцедержатель двойной поворотный
cm 4,5 L x 43 P x 19 H

• 08	€ 235,00
• 16-25-36	€ 300,00



PR 18

Porta asciugamani snodo con porta sapone
Towel rail adjustable with soap dish
Porte serviettes orientables avec porte savon
Handtuchhalter schwenkbar mit Seifenschale
Полотенцедержатель двойной поворотный + керамическая мыльница
cm 4,5 L x 43 P x 21 H

• 08	€ 280,00
• 16-25-36	€ 350,00



PR 18 D

Porta asciugamani snodo con dosatore
Towel rail adjustable with soap dispenser
Porte serviettes orientables avec porte savon liquid
Handtuchhalter schwenkbar mit Seifenspender
Полотенцедержатель двойной поворотный + керамический дозатор
cm 4,5 L x 43 P x 35 H

• 08	€ 335,00
• 16-25-36	€ 410,00



PR 07

Anello porta salviette
Ring serviette holder
Porte serviettes à anneau
Handtuchring
Полотенцедержатель - кольцо
cm 23 L x 9 P x 21 H

• 08	€ 105,00
• 16-25-36	€ 130,00



PR 09

Porta sapone a parete
Wall mounted soap dish
Porte savon à mur
Seifenschale wandhängend
Настенная керамическая мыльница
cm 11 L x 12,5 P x 10,5 H

• 08 bianco / white / blanc / weiß / белый	€ 110,00
• 16-25-36 bianco / white / blanc / weiß	€ 135,00
• 08 nero / black / noir / schwarz / черно	€ 115,00
• 16-25-36 nero / black / noir / schwarz	€ 150,00



PR 10

Porta bicchiere a parete
Wall mounted glass holder
Porte verre à mur
Zahnbürstenhalter wandhängend
Настенный керамический стакан
cm 7,5 L x 10,5 P x 17,5 H

• 08 bianco / white / blanc / weiß / белый	€ 115,00
• 16-25-36 bianco / white / blanc / weiß	€ 145,00
• 08 nero / black / noir / schwarz / черно	€ 120,00
• 16-25-36 nero / black / noir / schwarz	€ 150,00



PR 30

Dosatore sapone liquido a parete
Wall mounted soap dispenser
Porte savon liquid à mur
Seifenspender wandhängend
Настенный стеклянный дозатор
cm 7,5 L x 10,5 P x 26 H

• 08 bianco / white / blanc / weiß / белый	€ 155,00
• 16-25-36 bianco / white / blanc / weiß	€ 195,00
• 08 nero / black / noir / schwarz / черно	€ 155,00
• 16-25-36 nero / black / noir / schwarz	€ 205,00

PR 11 36
PR 039 36





794

Porta sapone da appoggio
Soap dish with base
Porte savon d'appui
Seifenschale
Настольная керамическая мыльница
cm 10 L x 10 P x 10 H

- bianco / white / blanc / weiß / белый € 21,00
- nero / black / noir / schwarz / черно € 28,00



793

Bicchiere da appoggio
Glass with base
Verre d'appui
Zahnputzbecher
Настольный керамический стакан
cm 7,5 L x 7,5 P x 10 H

- bianco / white / blanc / weiß / белый € 25,00
- nero / black / noir / schwarz / черно € 30,00



795

Dosatore sapone liquido da appoggio
Liquid soap dispenser
Porte savon liquid
Seifenspender
Настольный керамический дозатор
cm 7,5 L x 7,5 P x 10 H

- 08 bianco / white / blanc / weiß / белый € 72,00
- 16-25-36 bianco / white / blanc / weiß € 83,00
- 08 nero / black / noir / schwarz / черно € 78,00
- 16-25-36 nero / black / noir / schwarz € 88,00



PR 13

Porta accappatoio (2 ganci)
Robie hook (2 hooks)
Porte peignoir (2 peignoir)
Bademantelhaken (2 Haken)
Крючок двойной
cm 8 L x 9 P x 4,5 H

- 08 € 90,00
- 16-25-36 € 104,00



PR 11

Porta rotolo
Paper holder
Porte rouleau
Papierrollenhalter
Бумагодержатель
cm 19 L x 9 P x 4,5 H

- 08 € 92,00
- 16-25-36 € 107,00



PR 11 C

Porta rotolo coperto
Covered paper holder
Porte rouleau avec couvercle
Papierrollenhalter mit Deckel
Бумагодержатель закрытый
cm 20 L x 11 P x 11 H

- 08 € 120,00
- 16-25-36 € 142,00



PR 796

Porta scopino d'appoggio in ceramica
Ceramic toilet brush
Porte balayent en ceramique
Bürstengarnitur freistehend aus Keramik
Напольный керамический ёрш
cm 10 L x 10 P x 38 H

- 08 bianco / white / blanc / weiß / белый € 103,00
- 16-25-36 bianco / white / blanc / weiß € 107,00
- 08 nero / black / noir / schwarz / черно € 110,00
- 16-25-36 nero / black / noir / schwarz € 115,00



PR 039

Porta scopino da appoggio
Toilet-brush with base
Porte balayent d'appui
Bürstengarnitur freistehend
Напольный металлический ёрш
cm 8 L x 8,5 P x 41 H

- 08 € 184,00
- 16-25-36 € 230,00



PR 039 M

Porta scopino a parete
Wall mounted toilet brush
Porte balayent à mur
Bürstengarnitur wandhängend
Настенный металлический ёрш
cm 8 L x 8,5 P x 41 H

- 08 € 206,00
- 16-25-36 € 260,00



PR 11.11 S

Porta rotolo con scorta
Paper holder with supply
Porte rouleau avec escorte
Papierrollenhalter mit Ersatzhalter
Настенный металлический ёрш
cm 24 L x 9 P x 13 H

- 08 € 148,00
- 16-25-36 € 188,00



PR 1016

Maniglia per box doccia
Handle for shower enclosure
Poignée pour cabinets de douche
Handgriff für Duschkabinen
Ручка для душевого угла
cm 2 L x 6 P x 26 H-INT. 14

- 08 € 86,00
- 16-25-36 € 110,00



OPZIONI E COMPLEMENTI / OPTIONS AND COMPLEMENTS / OPTIONS ET COMPLÉMENTS / OPTIONEN UND ERGÄNZUNGEN / варианты и дополнения

* FINITURA DISPONIBILE IN 20 GG. / Finish available in 20 days / Finition disponible en 20 jours / Oberfläche lieferbar in 20 Tagen / Отделка доступна в течение 20 дней



08

CROMO
Chrome
Chrom
хром



16*

ORO
Gold
Or
Gold
Золото



25*

BRONZO
Bronze
Bronze
Bronze
Бронза



36*

NICHEL SATINATO
Satin nickel
Nickel satiné
Nickel satiniert
Никель сатин



Reversibile su richiesta / Reversible on request / Réversible sur demande / Umkehrbar auf Anfrage / Реверсивный по запросу



Su richiesta si realizzano aste porta asciugamani su misura, 10 gg

Customized towel rails are available on request, 10 days
Des porte-serviettes personnalisés sont disponibles sur demande, 10 jours
Handtuchhalter sind auf Anfrage erhältlich, 10 Tagen
По запросу мы можем производить полотенцедержатели под размер 10 дней



- 08 30 → 49 cm € 170,00
- 08 51 → 100 cm € 195,00
- 16-25-36 30 → 49 cm € 205,00
- 16-25-36 51 → 100 cm € 230,00



> pag. 301



> pag. 330



> pag. 344



> pag. 375



> pag. 375



> pag. 375



> pag. 474



MARTE

Designer: STILHAUS

Materiale: Ottone, Tubo Ø 16, basetta a muro Ø 70
 Accessori: Vetro Trasparente
 Finitura: 08-16-25 - 36
 Fuori misura: Si
 Incollo: Si

Material: Brass tube Ø 16, fixing plate cover Ø 70
 Accessories: Transparent glass
 Finishes: 08-16-25 - 36
 Customized: Yes
 By glue : Yes

Matière: Laiton, tuyau Ø 16, boucle couvre-vis Ø 70
 Accessoires: Verre transparent
 Finitions: 08-16-25 - 36
 Personnalisé: Oui
 Incollo: Oui

Material: Messing Rohr Ø 16, Befestigungsplatten Oberfläche Ø 70
 Zubehör: Klarglas
 Ausführungen: 08-16-25 - 36
 Kundenwunsch: Ja
 Kleber: Ja

Материал: латунь Ø 16, Ø 70
 Аксессуары: прозрачное стекло
 Отделка: 08-16-25 - 36
 негабаритный: да
 Установка на клей: да

MARTE

MA 09 08
MA 10 08
MA 30 08



MARTE

MA 45 08



MA 11 08



MA 07 08



MARTE

MA 11 C 25



MARTE

MA 13 36



MA 45 16





MA 04

Mensola vetro 8mm
Shelf
Etegerè
Ablage
Стеклопанельная полка - толщина стекла 8mm
cm 60 L x 13 P x 7 H

• 08	€ 175,00
• 16 - 25 - 36	€ 220,00



MA 05

Asta porta asciugamani
Towel rail
Porte serviette
Handtuchhalter
Полотенцедержатель
cm 60 L x 9 P x 7 H - INT. 51,5

• 08	€ 185,00
• 16 - 25 - 36	€ 230,00



MA 45

Asta porta asciugamani
Towel rail
Porte serviette
Handtuchhalter
Полотенцедержатель
cm 49 L x 9 P x 7 H - INT. 40,5

• 08	€ 175,00
• 16 - 25 - 36	€ 225,00



MA 06

Asta porta salviette
Ring towel serviette
Porte serviettes anneau
Handtuchring
Полотенцедержатель
cm 39 L x 9 P x 7 H - INT. 30,5

• 08	€ 169,00
• 16 - 25 - 36	€ 215,00



MA 13

Porta accappatoio (2 ganci)
Robie hook (2 hooks)
Porte peignpir (2 peignoir)
Bademantelhaken (2 Haken)
Крючок двойной
cm 9 L x 8,5 P x 7 H

• 08	€ 105,00
• 16 - 25 - 36	€ 130,00



MA 11

Porta rotolo
Paper holder
Porte rouleau
Papierrollenhalter
Бумагодержатель
cm 19,5 L x 9 P x 7 H

• 08	€ 105,00
• 16 - 25 - 36	€ 130,00



MA 11 C

Porta rotolo con coperchio
Covered paper holder
Porte rouleau avec couvercle
Papierrollenhalter mit Deckel
Бумагодержатель с крышкой
cm 20,5 L x 14 P x 12 H

• 08	€ 125,00
• 16 - 25 - 36	€ 165,00



MA 039

Porta scopino
Toilet-brush
Porte balayent
Bürstengarnitur
Напольный металлический ёрш
cm 12,5 Ø x 41,5 H

• 08	€ 125,00
• 16 - 25 - 36	€ 165,00



MA 16

Porta asciugamani snodo 2 aste
Towel rail with 2 adjustable bar
Porte serviettes à 2 barres orientables
Handtuchhalter schwenkbar 2 Stangen
Полотенцедержатель двойной поворотный
cm 4,5 L x 43 P x 19 H

• 08	€ 250,00
• 16 - 25 - 36	€ 315,00



MA 07

Anello porta salviette
Ring towel serviette
Porte serviettes anneau
Handtuchring
Настенная стеклянная мыльница
cm 23,5 L x 8 P x 23,5 H

• 08	€ 105,00
• 16 - 25 - 36	€ 130,00



MA 09

Porta sapone a parete
Wall-mounted soap dish
Porte savon à mur
Seifenschale
Настенная стеклянная мыльница
cm 12,5 L x 15,5 P x 7 H

• 08	€ 82,00
• 16 - 25 - 36	€ 125,00



MA 10

Porta bicchiere a parete
Wall mounted glass holder
Porte verre à mur
Zahnbürstenhalter wandhängend
Настенный стеклянный стакан
cm 8 L x 13,5 P x 12 H

• 08	€ 82,00
• 16 - 25 - 36	€ 125,00



MA 30

Dosatore sapone liquido a parete
Wall mounted liquid soap dispenser
Doseur de savon liquid à mur
Seifenspender wandhängend
Настенный стеклянный дозатор
cm 7,5 L x 13,5 P x 19 H

• 08	€ 115,00
• 16 - 25 - 36	€ 140,00



MA 09 AP

Porta sapone da appoggio
Soap dish with base
Porte savon d'appui
Seifenschale freistehend
Настольная стеклянная мыльница
cm 12,5 Ø x 7 H

• 08	€ 89,00
• 16 - 25 - 36	€ 115,00



MA 10 AP

Porta bicchiere da appoggio
Glass holder with base
Porte verre d'appui
Zahnbürstenhalter freistehend
Настольный стеклянный стакан
cm 9 Ø x 14 H

• 08	€ 89,00
• 16 - 25 - 36	€ 115,00



MA 30 AP

Dosatore sapone liquido da appoggio
Soap dispenser with base
Porte savon d'appui
Seifenspender freistehend
Настольный стеклянный дозатор
cm 9 Ø x 19 H

• 08	€ 115,00
• 16 - 25 - 36	€ 145,00

OPZIONI E COMPLEMENTI / OPTIONS AND COMPLEMENTS / OPTIONS ET COMPLÉMENTS / OPTIONEN UND ERGÄNZUNGEN / варианты и дополнения

* FINITURA DISPONIBILE IN 20 GG. / Finish available in 20 days / Finition disponible en 20 jours / Oberfläche lieferbar in 20 Tagen / Отделка доступна в течение 20 дней



08

CROMO
Chrome
Chrome
Chrom
хром



16

ORO
Gold
Or
Gold
Золото



25

BRONZO
Bronze
Bronze
Bronze
Бронза



36*

NICHEL SATINATO
Satin nickel
Nickel satiné
Nickel matt
Никель сатин



Reversibile su richiesta / Reversible on request / Réversible sur demande / Umkehrbar auf Anfrage / Реверсивный по запросу



Su richiesta si realizzano aste porta asciugamani su misura, 15 gg

Customized towel rails are available on request, 15 days
Des porte-serviettes personnalisés sont disponibles sur demande, 15 jours
Handtuchhalter sind auf Anfrage erhältlich, 15 tagen
По запросу мы можем производить полотенцедержатели под размер 15 дней



• 08	28 → 48 cm	€ 175,00
• 08	50 → 100 cm	€ 208,00
• 16 - 25	28 → 48 cm	€ 235,00
• 16 - 25	50 → 100 cm	€ 255,00



> pag. 298

> pag. 330

> pag. 474

> pag. 344



REGAL

Designer: STILHAUS

Materiale: Ottone, Tubo Ø 16, basetta a muro Ø 50
Accessori: Vetro Trasparente
Finitura: 08-16-18-25-41
Fuori misura: Si

Material: Brass tube Ø 16, fixing plate cover Ø 50
Accessories: Transparent glass
Finishes: 08-16-18-25-41
Customized: Yes

Matière: Laiton, tuyau Ø 16, boucle couvre-vis Ø 50
Accessoires: Verre transparent
Finitions: 08-16-18-25-41
Personnalisé: Oui

Material: Messing Rohr Ø 16, Befestigungsplatten Oberfläche Ø 50
Zubehör: Klarglas
Ausführungen: 08-16-18-25-41
Kundenwunsch: Ja

Материал: латунь Ø 16, Ø 50
Аксессуары: прозрачное стекло
Отделка: 08-16-18-25-41
Негабаритный: да

REGAL

RG 13 18



REGAL

RG 45 16



1130 08
1131 08



RG 30 08



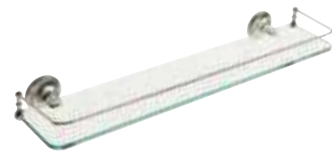

RG 04

Mensola vetro 8mm
Shelf
Etegerè
Ablage
Стеклопанель полка - толщина стекла 8mm
cm 60 L x 13 P x 7 H

• 08	€ 158,00
• 16 - 18 - 25	€ 205,00



RG 05

Asta porta asciugamani
Towel rail
Porte serviette
Handtuchhalter
Полотенцедержатель
cm 64 L x 9 P x 7 H - INT. 58

• 08	€ 157,00
• 16 - 18 - 25	€ 205,00



RG 45

Asta porta asciugamani
Towel rail
Porte serviette
Handtuchhalter
Полотенцедержатель
cm 45 L x 9 P x 7 H - INT. 39

• 08	€ 150,00
• 16 - 18 - 25	€ 195,00



RG 06

Asta porta salviette
Ring towel serviette
Porte serviettes anneau
Handtuchring
Полотенцедержатель
cm 37,5 L x 9 P x 7 H - INT. 31

• 08	€ 140,00
• 16 - 18 - 25	€ 185,00



1130

Porta bicchiere da appoggio
Glass holder with base
Porte verre d'appui
Zahnbrüstenhalter freistehend
Настольный стеклянный стакан
cm 6 Ø x 14 H

• 08	€ 69,00
• 16 - 18 - 25	€ 99,00



1131

Dosatore sapone liquido da appoggio
Soap dispenser with base
Porte savon d'appui
Seifenspender freistehend
Настольный стеклянный дозатор
cm 6 Ø x 19 H

• 08	€ 110,00
• 16 - 18 - 25	€ 165,00



RG 13.1

Porta accappatoio
Robie hook
Porte peignpir
Bademantelhaken
Крючок двойной
cm 9 L x 8,5 P x 7 H

• 08	€ 52,00
• 16 - 18 - 25	€ 75,00



RG 13.2

Porta accappatoio (2 ganci)
Robie hook (2 hooks)
Porte peignpir (2 peignoir)
Bademantelhaken (2 Haken)
Крючок двойной
cm 6 L x 8,5 P x 6 H

• 08	€ 89,00
• 16 - 18 - 25	€ 115,00



RG 16

Porta asciugamani snodo 2 aste
Towel rail with 2 adjustable bar
Porte serviettes à 2 barres orientables
Handtuchhalter schwenkbar 2 Stangen
Полотенцедержатель двойной поворотный
cm 43 L x 43 P x 19 H

• 08	€ 235,00
• 16 - 18 - 25	€ 305,00



RG 07

Anello porta salviette
Ring towel serviette
Porte serviettes anneau
Handtuchring
Полотенцедержатель - кольцо
cm 23,5 L x 8 P x 16 H

• 08	€ 102,00
• 16 - 18 - 25	€ 130,00



RG 79

Anello porta salviette con porta sapone
Ring serviette holder with soap holder
Porte serviettes à anneau avec porte savon
Handtuchring mit Seifenschale
Полотенцедержатель - полукольцо +
стеклянная мыльница
cm 30 L x 10 P x 16H

• 08	€ 155,00
• 16 - 18 - 25	€ 220,00



RG 79 D

Anello porta salviette con dosatore sapone
Ring serviette holder with soap dispenser
Porte serviettes à anneau avec porte savon liquid
Handtuchring mit Seifenspender
Полотенцедержатель - полукольцо +
стеклянный дозатор
cm 30 L x 9 P x 22 H

• 08	€ 190,00
• 16 - 18 - 25	€ 260,00



RG 11

Porta rotolo
Paper holder
Porte rouleau
Papierrollenhalter
Бумагодержатель
cm 20,5 L x 9 P x 12 H

• 08	€ 94,00
• 16 - 18 - 25	€ 130,00



RG 11 C

Porta rotolo con coperchio
Covered paper holder
Porte rouleau avec couvercle
Papierrollenhalter mit Deckel
Бумагодержатель с крышкой
cm 20,5 L x 14 P x 9 H

• 08	€ 120,00
• 16 - 18 - 25	€ 165,00



RG 039

Porta scopino
Toilet-brush
Porte balayent
Bürstengarnitur
Напольный металлический ёрш
cm 12,5 Ø x 41,5 H

• 08	€ 125,00
• 16 - 18 - 25	€ 165,00



RG 039 M

Porta scopino a parete
Wall mounted toilet brush
Porte balayent à mur
Bürstengarnitur wandhängend
Настенный металлический ёрш
cm 8 L x 8,5 P x 41 H

• 08	€ 135,00
• 16 - 18 - 25	€ 175,00



RG 09

Porta sapone a parete
Wall-mounted soap dish
Porte savon à mur
Seifenschale
Настенная стеклянная мыльница
cm 12,5 L x 15,5 P x 7 H

• 08	€ 75,00
• 16 - 18 - 25	€ 99,00



RG 10

Porta bicchiere a parete
Wall mounted glass holder
Porte verre à mur
Zahnbrüstenhalter wandhängend
Настенный стеклянный стакан
cm 8 L x 13,5 P x 12 H

• 08	€ 82,00
• 16 - 18 - 25	€ 103,00



RG 30

Dosatore sapone liquido a parete
Wall mounted liquid soap dispenser
Doseur de savon liquid à mur
Seifenspender wandhängend
Настенный стеклянный дозатор
cm 7,5 L x 13,5 P x 19 H

• 08	€ 115,00
• 16 - 18 - 25	€ 145,00



RG 09 AP

Porta sapone da appoggio
Soap dish with base
Porte savon d'appui
Seifenschale freistehend
Настольная стеклянная мыльница
cm 12,5 Ø x 2 H

• 08	€ 49,00
• 16 - 18 - 25	€ 79,00

OPZIONI E COMPLEMENTI / OPTIONS AND COMPLEMENTS / OPTIONS ET COMPLÉMENTS / OPTIONEN UND ERGÄNZUNGEN / варианты и дополнения



Reversibile su richiesta / Reversible on request / Réversible sur demande / Umkehrbar auf Anfrage / Реверсивный по запросу

* FINITURA DISPONIBILE IN 20 GG. / Finish available in 20 days / Finition disponible en 20 jours / Oberfläche lieferbar in 20 Tagen / Отделка доступна в течение 20 дней



08 CROMO
Chrome
Chrome
Chrom
хром



16* ORO
Gold
Or
Gold
Золото



18* ORO OPACO
Matt gold
L'or mat
Mattes Gold
матовое золото



25 BRONZO
Bronze
Bronze
Bronze
Бронза





SMART LIGHT

Designer: STILHAUS

Materiale: ottone, Tubo Ø 16, basetta a muro Ø 45
Accessori: Vetro trasparente
Finitura: 08-16-25
Fuori misura: Si

Material: Brass tube Ø 16, fixing plate cover Ø 45
Accessories: Transparent glass
Finishes: 08-16-25
Customized: Yes

Matière: Laiton, tuyau Ø 16, boucle couvre-vis Ø 45
Accessoires: Verre transparent
Finitions: 08-16-25
Personnalisé: Oui

Material: Messing Rohr Ø 16, Befestigungsplatten Oberfläche Ø 45
Zubehör: Klarglas
Ausführungen: 08-16-25
Kundenwünsche: Ja

Используемый материал: латунь Ø 16, Ø 45
Аксессуары: прозрачное стекло
Отделка: 08-16-25
Негабаритный: да

SL 45 08



SL 09 08
SL 30 08



SL 07 08



SL 11 16





SL 04

Mensola vetro 8mm
Shelf
Etagère
Ablage
Стеклопанель полка - толщина стекла 8mm
cm 70 L x 13 P x 5 H - INT. 67

• 08	€ 185,00
• 16 - 25	€ 235,00



SL 05

Asta porta asciugamani
Towel rail
Porte serviettes
Handtuchhalter
Полотенцедержатель
cm 62 L x 7 P x 5 H - INT. 49,5

• 08	€ 115,00
• 16 - 25	€ 145,00



SL 45

Asta porta asciugamani
Towel rail
Porte serviettes
Handtuchhalter
Полотенцедержатель
cm 45 L x 7 P x 5 H - INT. 37,5

• 08	€ 108,00
• 16 - 25	€ 140,00



SL 06

Asta porta salviette
Towel rail
Porte serviettes
Handtuchhalter
Полотенцедержатель
cm 39 L x 7 P x 5 H - INT. 28

• 08	€ 104,00
• 16 - 25	€ 135,00



SL 11 C

Porta rotolo coperto
Covered paper holder
Porte rouleau avec couvercle
Papierrollenhalter mit Deckel
Бумагодержатель закрытый
cm 19 L x 7 P x 5 H

• 08	€ 102,00
• 16 - 25	€ 130,00



SL 039 M

Porta scopino a parete
Wall mounted toilet-brush
Porte balaynet à mur
Bürstengarnitur wandhängend
Настенный металлический ёрш
cm 8,5 Ø x 38 H

• 08	€ 120,00
• 16 - 25	€ 152,00



SL 039

Porta scopino da appoggio
Toilet-brush with base
Porte balaynet d'appui
Bürstengarnitur freistehend
Напольный металлический ёрш
cm 12,5 Ø x 38 H

• 08	€ 115,00
• 16 - 25	€ 155,00



SL 1016

Maniglia per box doccia
Handle for shower enclosure
Poignée pour cabinets de douche
Handgriff für Duschkabinen
Ручка для душевого угла
cm 3 L x 6 P x 24 H - INT. 14

• 08	€ 86,00
• 16 - 25	€ 110,00



SL 16

Porta asciugamani snodo 2 aste
Towel rail with 2 adjustable bar
Porte serviettes à 2 barres orientables
Handtuchhalter schwenkbar 2 Stangen
Полотенцедержатель двойной поворотный
cm 4 L x 4/35 P x 9 H

• 08	€ 155,00
• 16 - 25	€ 205,00



SL 07

Anello porta salviette
Ring serviette holder
Porte serviettes à anneau
Handtuchring
Полотенцедержатель - кольцо
cm 20,5 L x 10 P x 25 H

• 08	€ 79,00
• 16 - 25	€ 96,00



SL 09

Porta sapone a parete
Wall mounted soap dish
Porte savon à mur
Seifenschale wandhängend
Настенная керамическая мыльница
cm 12 L x 13 P x 12 H

• 08	€ 89,00
• 16 - 25	€ 115,00



SL 10

Porta bicchiere a parete
Wall mounted glass holder
Porte verre à mur
Zahnbürstenhalter wandhängend
Настенный керамический стакан
cm 9 L x 12 P x 18 H

• 08	€ 92,00
• 16 - 25	€ 115,00



1269

Porta sapone da appoggio in cristallo
Crystal countertop soap dish
Porte-savon de comptoir en cristal
Seifenschale aus Kristall für die Arbeitsplatte
Хрустальная мыльница для столешницы
cm Ø 15 x 4 H

• TR	€ 125,00
------	----------



1270

Porta bicchiere da appoggio in cristallo
Crystal glass holder
Porte-verre en cristal
Kristallglashalter
Держатель из хрустального стекла
cm Ø 7,5 x 10 H

• TR	€ 195,00
------	----------



1271

Dosatore sapone liquido da appoggio in cristallo
Crystal liquid soap dispenser
Distributeur de savon liquide cristal de comptoir
Tischspender für Flüssigseife aus Kristall
Настольный кристаллический дозатор для жидкого мыла
cm Ø 7,5 x 15 H

• TR / 08	€ 310,00
• TR / 16 - 25	€ 360,00



SL 30

Dosatore sapone a parete
Wall mounted soap dispenser
Porte savon liquid à mur
Seifenspender wandhängend
Настенный дозатор
cm 12 L x 13 P x 21 H

• 08	€ 120,00
• 16 - 25	€ 152,00



SL 15

Porta sapone + Porta bicchiere da appoggio
Soap dish + Glass holder
Porte savon + Porte verre
Seifenschale + Zahnbürstenhalter freistehend
Настольная мыльница + стакан
cm Ø 12,5 x 25 L x 18 H

• 08	€ 195,00
• 16 - 25	€ 250,00



SL 13

Porta accappatoio
Robe hook
Porte peignoir
Bademantelhaken
Крючок
cm 5 L x 7 P x 11 H

• 08	€ 62,00
• 16 - 25	€ 82,00



SL 11

Porta rotolo
Paper holder
Porte rouleau
Papierrollenhalter
Бумагодержатель
cm 5 L x 7 P x 11 H

• 08	€ 68,00
• 16 - 25	€ 90,00

OPZIONI E COMPLEMENTI / OPTIONS AND COMPLEMENTS / OPTIONS ET COMPLÉMENTS / OPTIONEN UND ERGÄNZUNGEN / варианты и дополнения



08

CROMO
Chrome
Chrom
хром

16

ORO
Gold
Or
Gold
Золото

25

BRONZO
Bronze
Bronze
Bronze
Бронза



Su richiesta si realizzano aste porta asciugamani su misura, 20 gg

Customized towel rails are available on request, 20 days
Des porte-serviettes personnalisés sont disponibles sur demande, 20 jours
Handtuchhalter sind auf Anfrage erhältlich, 20 tagen
По запросу мы можем производить полотенцедержатели под размер 20 дней



• 08	30 → 44 cm	€ 130,00
• 08	46 → 100 cm	€ 145,00
• 16 - 25	30 → 44 cm	€ 168,00
• 16 - 25	46 → 100 cm	€ 189,00



GIUNONE

Designer: STILHAUS

Materiale: Ottone, Tubo Ø 15, basetta a muro Ø 63
Accessori: Ceramica bianca
Finitura: 08-02-16-25-26-36
Fuori misura: Sì

Material: Brass tube Ø15, fixing plate cover Ø 63
Accessories: White ceramic
Finishes: 08-02-16-25-26-36
Customized: Yes

Matière: Laiton, tuyau Ø 15,
boucle couvre-vis Ø 63
Accessoires: blanc céramique
Finitions: 08-02-16-25-26-36
Personnalisé: Oui

Material: Messing Rohr Ø 15,
Befestigungsplatten Oberfläche Ø 63
Zubehör: weiße Keramik
Ausführungen: 08-02-16-25-26-36
Kundenwunsch: Ja

Материал: латунь Ø 15, Ø 63
Аксессуары: белая керамика
Отделка: 08-02-16-25-26-36
Негабаритный: да

G 07 16
G 09 16



G 15 08



G 05.2 08



G 16 08





G 04

Mensola vetro 8mm
Shelf
Etagère
Ablage
Стеклопанельная полка - толщина стекла 8 mm
cm 70 L x 13 P x 6 H - INT. 61

• 08	€ 175,00
• 02	€ 195,00
• 16 - 25 - 26 - 36	€ 230,00

G 33

Mensola e porta asciugamani
Shelf and towel rail
Etagère et porte serviette
Ablage mit Handtuchhalter
Стеклопанельная полка + полотенцедержатель
cm 60 L x 15 P x 9 H - INT. 51

• 08	€ 220,00
• 02	€ 235,00
• 16 - 25 - 26 - 36	€ 285,00

G 05

Asta porta asciugamani
Towel rail
Porte serviette
Handtuchhalter
Полотенцедержатель
cm 60 L x 8 P x 6 H - INT. 51

• 08	€ 125,00
• 02	€ 147,00
• 16 - 25 - 26 - 36	€ 170,00

G 05.2

Porta asciugamani doppia asta
Towel rail with 2 bars
Porte serviette avec 2 barres
Handtuchhalter schwenkbar 2 Stangen
Полотенцедержатель двойной
cm 60 L x 14 P x 9 H - INT. 51

• 08	€ 185,00
• 02	€ 215,00
• 16 - 25 - 26 - 36	€ 240,00



G 06

Asta porta asciugamani
Towel rail
Porte serviette
Handtuchhalter
Полотенцедержатель
cm 40,5 L x 8 P x 6 H - INT. 31

• 08	€ 115,00
• 02	€ 142,00
• 16 - 25 - 26 - 36	€ 165,00

G 16

Porta asciugamani snodo 2 aste
Towel rail with 2 adjustable bar
Porte serviettes à 2 barres orientables
Handtuchhalter schwenkbar 2 Stangen
Полотенцедержатель двойной поворотный
cm 38 L x 8 P x 16 H

• 08	€ 140,00
• 02	€ 165,00
• 16 - 25 - 26 - 36	€ 195,00

G 69

Asta porta salviette con porta sapone
Towel rail with soap dish
Porte serviettes avec porte savon
Handtuchhalter mit Seifenschale
Полотенцедержатель + керамическая мыльница
cm 50 L x 13 P x 6 H - INT. 31

• 08	€ 165,00
• 02	€ 180,00
• 16 - 25 - 26 - 36	€ 215,00

G 69 D

Asta porta salviette con dosatore sapone
Towel rail with soap dispenser
Porte serviettes avec porte savon liquid
Handtuchhalter mit Seifenspender
Полотенцедержатель + керамический дозатор
cm 50 L x 13 P x 6 H - INT. 31

• 08	€ 185,00
• 02	€ 205,00
• 16 - 25 - 26 - 36	€ 250,00



G 79

Porta salviette con porta sapone
Wall mounted holder serviette + soap dish
Porte serviette + Porte savon mural
Handtuchhalter + Seifenschale
Полотенцедержатель - полукольцо + керамическая мыльница
cm 31 L x 13 P x 13 H

• 08	€ 160,00
• 02	€ 185,00
• 16 - 25 - 26 - 36	€ 215,00

G 07

Anello porta salviette
Ring serviette holder
Porte serviettes à anneau
Handtuchring
Полотенцедержатель - полукольцо
cm 31 L x 8 P x 13 H

• 08	€ 108,00
• 02	€ 130,00
• 16 - 25 - 26 - 36	€ 150,00

G 09

Porta sapone a parete
Wall mounted soap dish
Porte savon à mur
Seifenschale wandhängend
Настенная керамическая мыльница
cm 24 L x 13 P x 6 H

• 08	€ 89,00
• 02	€ 104,00
• 16 - 25 - 26 - 36	€ 120,00

G 10

Porta bicchiere a parete
Wall mounted glass holder
Porte verre à mur
Zahnbürstenhalter wandhängend
Настенный керамический стакан
cm 18 L x 13 P x 12 H

• 08	€ 89,00
• 02	€ 104,00
• 16 - 25 - 26 - 36	€ 120,00





G 30

Dosatore sapone liquido
Wall mounted soap dispenser
Porte savon liquid à mur
Seifenspender wandhängend
Настенный керамический
cm 24 L x 13 P x 6 H

•08	€ 115,00
•02	€ 130,00
•16-25-26-36	€ 160,00



G 14

Porta sapone con porta bicchiere a parete
Wall mounted soap dish + Glass holder
Porte savon + Porte verre à mur
Seifenschale + Zahnbürstenhalter wandhängend
Настенные керамические стакан + мыльница
cm 30 L x 13 P x 12 H

•08	€ 130,00
•02	€ 150,00
•16-25-26-36	€ 180,00



G 719

Porta sapone da appoggio
Soap dish with base
Porte savon d'appui
Seifenschale freistehend
Настольная керамическая мыльница
cm 13 L x 10 P x 11 H - base cm Ø 10

•08	€ 86,00
•02	€ 99,00
•16-25-26-36	€ 115,00



G 718

Porta bicchiere da appoggio
Glass holder with base
Porte verre d'appui
Zahnbürstenhalter freistehend
Настольный керамический стакан
cm 10 L x 15 P x 15 H - base cm Ø 10

•08	€ 86,00
•02	€ 99,00
•16-25-26-36	€ 115,00



G 039

Porta scopino da appoggio
Toilet brush with base
Porte balayent d'appui
Bürstengarnitur freistehend
Напольный металлический ёрш
cm 12 Ø x 38 H

•08	€ 115,00
•02	€ 120,00
•16-25-26-36	€ 145,00

OPZIONI E COMPLEMENTI / OPTIONS AND COMPLEMENTS / OPTIONS ET COMPLÉMENTS / OPTIONEN UND ERGÄNZUNGEN / варианты и дополнения

* FINITURA DISPONIBILE IN 20 GG. / Finish available in 20 days / Finition disponible en 20 jours / Oberfläche lieferbar in 20 Tagen / Отделка доступна в течение 20 дней



02

CROMO - ORO
Chrome - gold
Chrome - or
Chrom - Gold
Хром - золото



Reversibile su richiesta
Reversible on request / Réversible sur demande / Umkehrbar auf Anfrage / Реверсивный по запросу



G 720

Dosatore sapone liquido da appoggio
Soap dispenser with base
Porte savon d'appui
Seifenspender freistehend
Настольный стеклянный дозатор
cm Ø 8 x 18 H

•08	€ 110,00
•02	€ 125,00
•16-25-26-36	€ 140,00



G 15 M

Porta sapone con porta bicchiere da appoggio
Soap dish + Glass holder
Porte savon + Porte verre
Seifenschale + Zahnbürstenhalter freistehend
Настольные керамические стакан + мыльница
cm 30 L x 12,5 P x 16 H

•08	€ 155,00
•02	€ 185,00
•16-25-26-36	€ 210,00



G 13

Porta accappatoio (2 ganci)
Robie hook (2 hooks)
Porte peignoir (2 peignoir)
Bademantelhaken (2 Haken)
Крючок двойной
cm 12 L x 8 P x 6 H

•08	€ 68,00
•02	€ 80,00
•16-25-26-36	€ 92,00



G 13.1

Porta accappatoio singolo
Single robe hook
Porte peignoir
Bademantelhaken
Крючок одинарный
cm 5 L x 8 P x 6 H

•08	€ 44,00
•02	€ 52,00
•16-25-26-36	€ 58,00



G 11

Porta rotolo
Paper holder
Porte rouleau
Papierrollenhalter
Бумагодержатель
cm 25 L x 8 P x 6 H

•08	€ 83,00
•02	€ 95,00
•16-25-26-36	€ 115,00



G 11 C

Porta rotolo coperto
Covered paper holder
Porte rouleau avec couvercle
Papierrollenhalter mit Deckel
Бумагодержатель закрытый
cm 25 L x 11,5 P x 11 H

•08	€ 115,00
•02	€ 140,00
•16-25-26-36	€ 155,00



G 12 A

Porta scopino d'appoggio in ceramica
Ceramic toilet brush
Porte balayent en ceramique
Bürstengarnitur freistehend aus Keramik
Напольный керамический ёрш
cm Ø 13 x 40 H

•08	€ 89,00
•02	€ 92,00
•16-25-26-36	€ 120,00



G 12

Porta scopino a parete
Wall mounted toilet brush
Porte balayent à mur
Bürstengarnitur wandhängend
Настенный керамический ёрш
cm 10 L x 12 P x 34 H

•08	€ 130,00
•02	€ 158,00
•16-25-26-36	€ 179,00



Su richiesta si realizzano aste porta asciugamani su misura, 10 gg

Customized towel rails are available on request, 10 days
Des porte-serviettes personnalisés sont disponibles sur demande, 10 jours
Handtuchhalter sind auf Anfrage erhältlich, 10 tagen
По запросу мы можем производить полотенцедержатели под размер 10 дней

•08	30	→	59 cm	€ 145,00
•08	61	→	100 cm	€ 160,00
•02	30	→	59 cm	€ 160,00
•02	61	→	100 cm	€ 185,00
•16-25-26-36	30	→	59 cm	€ 185,00
•16-25-26-36	61	→	100 cm	€ 210,00



> pag. 301

> pag. 316

> pag. 344

> pag. 374

> pag. 470

> pag. 468



NEMI

DESIGNER: STILHAUS

Materiale: Ottone, tubo Ø 20, basetta a muro Ø 60, legno, ceramica bianca o decorata
Accessori: ceramica
Finitura: 33-39-40
Fuori misura: Sì
Incollo: Sì

Material: Brass tube Ø 16, fixing plate cove Ø60, wood, white or decorated ceramic
Accessories: Ceramic
Finishes: 33-39-40
Customized: Yes
By glue : Yes

Matière: laiton, tuyau Ø 16, boucle couvre-vis Ø 60, bois, blanc et noir céramique
Accessoires: Céramique
Finitions: 33-39-40
Personnalisé: Oui
Par collage : Oui
Designer: Stilhaus

Material: Messing Rohr Ø 16, Befestigungsplatten Oberfläche Ø60, Holz, Keramik weiß oder dekoriert
Zubehör: Keramik
Ausführungen: 33-39-40
Kundenwunsch: Ja
Kleber: Ja

Материал: латунь, дерево, Ø 16, Ø 60 белая или декорированная керамика
Аксессуары: керамика
Отделка: 33-39-40
Негабаритный: да
Установка на клей: да

NEMI

N 06 39



N 11 39
186 39



NEMI

N 15 33





N 04

Mensola vetro 8 mm
Shelf
Etagère
Ablage
Стеклопанельная полка - толщина стекла 8 mm
cm 70 L x 12 P x 10 H - INT. 62

• 33 - 39	€ 195,00
• 40	€ 205,00



N 05

Asta porta asciugamani
Towel rail
Porte serviette
Handtuchhalter
Полотенцедержатель
cm 60 L x 9 P x 10 H - INT. 51

• 33 - 39	€ 135,00
• 40	€ 155,00



N 05.2

Porta asciugamani doppia asta
Towel rail with 2 bars
Porte serviette avec 2 barres
Doppel Handtuchstange
Полотенцедержатель двойной
cm 60 L x 12 P x 16 H - INT. 51

• 33 - 39	€ 220,00
• 40	€ 245,00



N 06

Asta porta salviette
Serviette holder
Porte serviette
Handtuchhalter
Полотенцедержатель
cm 43 L x 9 P x 10 H - INT. 30

• 33 - 39	€ 130,00
• 40	€ 145,00



N 16

Porta asciugamani snodo 2 aste
Towel rail with 2 adjustable bar
Porte serviettes à 2 barres orientables
Handtuchhalter schwenkbar 2 Stangen
Полотенцедержатель двойной поворотный
cm 40 L x 4 P x 15 H

• 33 - 39	€ 160,00
• 40	€ 175,00



N 79

Porta salviette con porta sapone
Wall mounted holder serviette soap dish
Porte serviette + Porte savon à mur
Handtuchhalter + Seifenschale
Полотенцедержатель - полукольцо + мыльница
cm 35 L x 13 P x 18 H

• 33 - 39	€ 175,00
• 40	€ 190,00



N 07

Anello porta salviette
Ring serviette holder
Porte serviettes à anneau
Handtuchring
Полотенцедержатель - полукольцо
cm 35 L x 9 P x 18 H

• 33 - 39	€ 125,00
• 40	€ 135,00



N 09

Porta sapone a parete
Wall mounted soap dish
Porte savon à mur
Seifenschale wandhängend
Настенная керамическая мыльница
cm 21 L x 13 P x 10 H

• 33 - 39	€ 115,00
• 40	€ 130,00



N 10

Porta bicchiere a parete
Wall mounted glass holder
Porte verre mural
Zahnbürstenhalter wandhängend
Настенный керамический стакан
cm 18 L x 10 P x 18 H

• 33 - 39	€ 115,00
• 40	€ 130,00



N 14

Porta sapone con porta bicchiere a parete
Wall mounted soap dish + Glass holder
Porte savon + Porte verre mural
Seifenschale + Zahnbürstenhalter wandhängend
Настенные керамические мыльница + стакан
cm 32 L x 13 P x 18 H

• 33 - 39	€ 158,00
• 40	€ 168,00



N 09 AP

Porta sapone da appoggio
Soap dish with base
Porte savon d'appui
Seifenschale
Настольная керамическая мыльница
cm Ø 12 x 8 H

• 08	€ 78,00
------	---------



N 10 AP

Bicchiere in ceramica d'appoggio
Glass with base
Verre d'appui
Zahnputzbecher
Настольный керамический стакан
cm Ø 8 x 13 H

• 08	€ 78,00
------	---------





N 30 AP
 Dosatore sapone liquido d'appoggio
 Soap dispenser with base
 Doseur de savon liquid d'appui
 Seifenspender
 Настольный керамический дозатор
 cm Ø 8 x 21 H

• 08	€ 105,00
------	----------



745
 Contenitore in ceramica d'appoggio
 Container with base
 Containeur d'appui
 Keramik Dose
 Настольный керамический контейнер
 cm Ø 9 x 13 H

• 01	€ 60,00
• 40	€ 88,00



N 15 M
 Porta sapone con porta bicchiere da appoggio
 Soap dish + Glass holder
 Porte savon + Porte verre
 Seifenschale + Zahnbürstenhalter freistehend
 Настольные керамические мыльница + стакан
 cm 30 L x Ø 12,5 x 18 H

• 33 - 39	€ 162,00
• 40	€ 175,00



N 13
 Porta accappatoio (2 ganci)
 Robie hook (2 hooks)
 Porte peignoir (2 peignoir)
 Bademantelhaken (2 Haken)
 Крючок двойной
 cm 10 L x 9 P x 10 H

• 33 - 39	€ 75,00
• 40	€ 88,00



N 11 C
 Porta rotolo coperto
 Covered paper holder
 Porte rouleau avec couvercle
 Papierrollenhalter mit Deckel
 Полотенцедержатель с крышкой
 cm 20 L x 11 P x 12 H

• 33 - 39	€ 128,00
• 40	€ 145,00



N 11
 Porta rotolo
 Paper holder
 Porte rouleau
 Papierrollenhalter
 Бумагодержатель
 cm 21 L x 9 P x 10 H

• 33 - 39	€ 87,00
• 40	€ 90,00



186 GABRI
 Porta scopino d'appoggio in ceramica
 Ceramic toilet brush
 Porte balayent en ceramique
 Bürstengarnitur freistehend aus Keramik
 Напольный керамический ёрш
 cm 13 Ø x 43 H

• 33 - 39	€ 89,00
• 40	€ 115,00



N 039
 Porta scopino da appoggio
 Toilet brush with base
 Porte balayent d'appui
 Bürstengarnitur freistehend
 Напольный металлический ёрш
 cm 12,5 Ø x 42 H

• 33 - 39	€ 120,00
• 40	€ 125,00



840
 Kit collante e biadesivo per un articolo
 Kit with bi-adhesive and glue for one article
 Kit avec collant et biadhésif pour un article
 Klebekit ist ein beidseitiger Klebestreifen
 Клей

•	€ 4,80
---	--------



OPZIONI E COMPLEMENTI / OPTIONS AND COMPLEMENTS / OPTIONS ET COMPLÉMENTS / OPTIONEN UND ERGÄNZUNGEN / варианты и дополнения



39



CROMO - CER. BIANCO
 Chrome - Cer. white
 Chrome - Cér. blanc
 Chrom - Ker. weiß
 хром - белая керамика

40



CROMO - CER. DECORATA
 Chrome - Cer. white, decorated
 Chrome - Cér. blanc, décoré
 Chrom - Ker. weiß, bemalt
 хром - керамика декорированная

33



CROMO - NOCE SCURO
 Chrome - Dark walnut
 Chrome - Noix sombre
 Chrom - Nußbraun dunkel
 белый - дерево орех



Reversibile su richiesta / Reversible on request / Réversible sur demande / Umkehrbar auf Anfrage / Реверсивный по запросу



Su richiesta si realizzano aste porta asciugamani su misura, 15 gg

Customized towel rails are available on request, 15 days
 Des porte-serviettes personnalisés sont disponibles sur demande, 15 jours
 Handtuchhalter sind auf Anfrage erhältlich, 15 tagen
 По запросу мы можем производить полотенцедержатели под размер 15 дней



• 33 - 39	30 → 42 cm	€ 138,00
• 33 - 39	44 → 100 cm	€ 145,00
• 40	30 → 42 cm	€ 155,00
• 40	44 → 100 cm	€ 165,00



> pag. 300 > pag. 316 > pag. 336 > pag. 344 > pag. 373 > pag. 373 > pag. 474 > pag. 340



SMART

Designer: STILHAUS

Materiale: Ottone, Tubo Ø 16 , basetta a muro Ø 45
Accessori: Ceramica bianca
Finitura: 08-02-25
Fuori misura: Si

Material: Brass tube Ø 20, fixing plate cover Ø 45
Accessories: White ceramic
Finishes: 08-02-25
Customized: Yes

Matière: Laiton, tuyau Ø 16, boucle couvre-vis Ø 45
Accessoires: Blanc céramique
Finitions: 08-02-25
Personnalisé: Oui

Material: Messing Rohr Ø 16, Befestigungsplatten Oberfläche Ø 45
Zubehör: Weiße Keramik
Ausführungen: 08-02-25
Kundenwunsch: Ja

Используемый материал: латунь Ø 16, Ø 45
Аксессуары: белая керамика
Отделка: 08-02-25
Негабаритный: да

SMART

SM 09 08



SMART

SM 06 18



SM 11 08



SM 10 25



SM 10 25

241

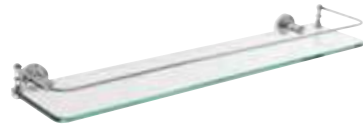

SM 04

Mensola vetro 8 mm
Shelf
Etagère
Ablage
Стеклопанельная полка - толщина стекла 8mm
cm 60 L x 15 P x 5 H

• 08	€ 138,00
• 02	€ 147,00
• 18 - 25	€ 175,00



SM 05

Asta porta asciugamani
Towel rail
Porte serviette
Handtuchhalter
Полотенцедержатель
cm 57 L x 7 P x 5 H - INT.49,5

• 08	€ 78,00
• 02	€ 86,00
• 18 - 25	€ 97,00



SM 45

Asta porta asciugamani
Towel rail
Porte serviette
Handtuchhalter
Полотенцедержатель
cm 44 L x 7 P x 5 H - INT.37,5

• 08	€ 76,00
• 02	€ 84,00
• 18 - 25	€ 95,00



SM 06.2

Asta porta salviette
Towel rail
Porte serviette
Handtuchhalter
Полотенцедержатель
cm 34 L x 7 P x 5 H - INT.28

• 08	€ 72,00
• 02	€ 80,00
• 18 - 25	€ 90,00



SM 11 C

Porta rotolo coperto
Covered paper holder
Porte rouleau avec couvercle
Papierrollenhalter mit Deckel
Бумагодержатель закрытый
cm 18 L x 10 P x 15 H

• 08	€ 82,00
• 02	€ 92,00
• 18 - 25	€ 105,00



SM 039M

Porta scopino a parete
Wall-mounted toilet-brush
Porte balayent à mur
Bürstengarnitur wandhängend
Настенный металлический ёрш
cm Ø 8,5 x 36 H

• 08	€ 86,00
• 02	€ 92,00
• 18 - 25	€ 110,00



SM 039

Porta scopino da appoggio
Toilet brush with base
Porte balayent d'appui
Bürstengarnitur freistehend
Напольный металлический ёрш
cm Ø 8,5 x 36 H

• 08	€ 75,00
• 02	€ 84,00
• 18 - 25	€ 100,00



SM 823

Porta bicchiere a parete
Wall mounted glass holder
Porte verre à mur
Zahnbürstenhalter wandhängend
Настенный керамический стакан
cm 9 L x 13 P x 10 H

• 08	€ 98,00
• 02	€ 105,00
• 18 - 25	€ 125,00



185

Porta asciugamani snodo 2 aste
Towel rail with 2 adjustable bar
Porte serviettes à 2 barres orientables
Handtuchhalter schwenkbar 2 Stangen
Полотенцедержатель двойной поворотный
cm 36 L x 4 P x 13 H

• 08	€ 140,00
• 02	€ 148,00
• 18 - 25	€ 175,00



SM 07

Anello porta salviette
Ring serviette holder
Porte serviettes à anneau
Handtuchring
Полотенцедержатель - кольцо
cm 20,5 L x 7,5 P x 22 H

• 08	€ 62,00
• 02	€ 82,00
• 18 - 25	€ 92,00



SM 09

Porta sapone a parete
Wall mounted soap dish
Porte savon à mur
Seifenschale wandhängend
Настенная керамическая мыльница
cm 15 L x 13 P x 6 H

• 08	€ 47,00
• 02	€ 54,00
• 18 - 25	€ 60,00



SM 10

Porta bicchiere a parete
Wall mounted glass holder
Porte verre à mur
Zahnbürstenhalter wandhängend
Настенный керамический стакан
cm 9 L x 13 P x 10 H

• 08	€ 48,00
• 02	€ 54,00
• 18 - 25	€ 60,00



SM039B

Porta scopino da appoggio
Toilet brush with base
Porte balayent d'appui
Bürstengarnitur freistehend
Напольный металлический ёрш
cm 12,5 Ø x 40 H

• 08	€ 110,00
• 02	€ 115,00
• 18 - 25	€ 140,00



SM 12A

Porta scopino d'appoggio in ceramica
Ceramic toilet brush
Porte balayent en ceramique
Bürstengarnitur freistehend aus Keramik
Напольный керамический ёрш
cm 13 Ø x 40 H

• 08	€ 85,00
• 02	€ 90,00
• 18 - 25	€ 105,00



SM 12

Porta scopino a parete
Wall-mounted toilet-brush
Porte balayent à mur
Bürstengarnitur wandhängend
Настенный металлический ёрш
cm Ø 8,5 x 36 H

• 08	€ 125,00
• 02	€ 134,00
• 18 - 25	€ 160,00



SM 30

Dosatore sapone a parete
Wall mounted soap dispenser
Porte savon liquid à mur
Seifenspender wandhängend
Настенный дозатор
cm 9 L x 13 P x 18 H

• 08	€ 80,00
• 02	€ 90,00
• 18 - 25	€ 100,00



SM 13

Porta accappatoio (2 ganci)
Robie hook (2 hooks)
Porte peignoir (2 peignoir)
Bademantelhaken (2 Haken)
Крючок двойной
cm 11 L x 7 P x 5 H

• 08	€ 48,00
• 02	€ 57,00
• 18 - 25	€ 62,00



SM 13.1

Porta accappatoio singolo
Robe hook
Porte peignoir
Bademantelhaken
Крючок
cm 5 L x 6,5 P x 5 H

• 08	€ 37,00
• 02	€ 40,00
• 18 - 25	€ 48,00



SM 11

Porta rotolo
Paper holder
Porte rouleau
Papierrollenhalter
Бумагодержатель
cm 17 L x 7 P x 5 H

• 08	€ 51,00
• 02	€ 58,00
• 18 - 25	€ 65,00

SM 06 18



OPZIONI E COMPLEMENTI / OPTIONS AND COMPLEMENTS / OPTIONS ET COMPLÉMENTS / OPTIONEN UND ERGÄNZUNGEN / варианты и дополнения

* FINITURA DISPONIBILE IN 20 GG. / Finish available in 20 days / Finition disponible en 20 jours / Oberfläche lieferbar in 20 Tagen / Отделка доступна в течение 20 дней



08



CROMO
Chrome
Chrome
Chrom
хром

02



CROMO - ORO
Chrome - Gold
Chrome - Or
Chrom - Gold
Хром - золото

25



BRONZO
Bronze
Bronze
Bronze
Бронза

18*



ORO OPACO
Matt gold
L'or mat
Mattes Gold
матовое золото



Su richiesta si realizzano aste porta asciugamani su misura, 10 gg

Customized towel rails are available on request, 10 days
Des porte-serviettes personnalisés sont disponibles sur demande, 10 jours
Handtuchhalter sind auf Anfrage erhältlich, 10 Tagen
По запросу мы можем производить полотенцедержатели под размер 10 дней



• 08	28 → 43 cm	€ 94,00
• 08	45 → 100 cm	€ 105,00
• 02	28 → 43 cm	€ 100,00
• 02	45 → 100 cm	€ 110,00
• 25	28 → 43 cm	€ 118,00
• 25	45 → 100 cm	€ 130,00



> pag. 300



> pag. 336



> pag. 344



> pag. 471



> pag. 474



> pag. 340



563

Specchio sagomato con molatura a bastone
Cut mirror with grinding
Miroir coupé avec meulage
Geformter Spiegel mit Rundschliff
Овальное зеркало
cm 70 L x 90 H

€ 350,00

1062 LED

Applique
Wall mounted applique
Applique à mur
Wandleuchte
Настенные светильники
cm ø 10 x 19 P x 20 H
CE : V 220 IP44 3W 3000K

• 08	€ 165,00
• 16 - 25	€ 205,00

1049

Struttura porta lavabo in ottone con mensola in vetro
Brass support with glass shelf
Support avec glass étagère
Waschtischkonsole aus Messing mit Glasablage
Каркас из хромированной латуни со стеклянной полкой
cm 52 L x 51 P x 78 H

• 08	€ 950,00
• 16 - 25	€ 1.200,00

1050

Lavabo in ceramica in stile
Ceramic washbasin
Lavabo en céramique
Waschtisch aus Keramik im klassischen Stil
Керамическая раковина
cm 70 L x 58 P x 26 H

• 01	€ 340,00
------	----------

RAC 393

Sifone tornito in ottone 1" ¼
Brass siphon 1" ¼
Siphon en laiton 1" ¼
Siphon aus Messing 1" ¼
Хромированный 1" ¼

• 08	€ 86,00
• 16 - 25 - 26	€ 230,00



SPECCHI

Designers: STILHAUS, SETTIMELLI, PALUDI, TALOCCI, PALLOCCA

Designer: Stilhaus, Settimelli, Paludi, Talocci, Pallocca
Materiale: specchio 5 mm
Fuori misura: Si

Designer: Stilhaus, Settimelli, Paludi, Talocci, Pallocca
Material: Mirror 5 mm
Customized: Yes

Designer: Stilhaus, Settimelli, Paludi, Talocci, Pallocca
Matière: Miroir 5 mm
Personnalisé: Oui

Designer: Stilhaus, Settimelli, Paludi, Talocci, Pallocca
Material: Spiegel 5 mm
Kundenwunsch: Ja

Разработка дизайна: Stilhaus, Settimelli, Paludi, Talocci, Pallocca
Используемый материал: зеркало 5 мм
Негабаритный: да



488

Specchio ingranditore 3x a parete con supporto flessibile
Wall mounted enlarging mirror 3x with flexible support
Miroir agrandisseur à mur 3x avec je supporte flexible
Wandspiegel Vergrößerung 3x mit flexibler Wandhalterung
Настенное косметическое зеркало с 3-х кратным увеличением на гибком держателе
cm Ø 14 x 14 P • Base Ø 7,5

• 08

€ 135,00



751

Specchio ingranditore 3x rettangolare a parete
Wall mounted rectangular enlarging mirror 3x
Miroir agrandisseur 3x rectangulaire à mur
Rechteckiger Wandspiegel mit Vergrößerung 3x
Настенное косметическое зеркало с 3-х кратным увеличением
cm 14 L x 27 P x 20 H • Base 4 L x 2 P x 9 H

• 08

€ 125,00



16

23

25

17

36



1035

Specchio ingranditore 3x a parete con supporto snodato singolo
Wall mounted enlarging mirror 3x with single adjustable support
Miroir agrandisseur à mur 3x avec je supporte flexible
Wand-Vergrößerungsspiegel 3x mit LED-Beleuchtung
Настенное косметическое зеркало с 3-х кратным увеличением на гибком держателе
Cm Ø 14 x 20 P Max x H14 • Base Ø 5

• 08

€ 155,00

• 23

€ 175,00

• 16 - 25 - 36

€ 210,00

• 17

€ 235,00



1093

Specchio ingranditore 3x a parete con supporto snodato singolo
Wall mounted enlarging mirror 3x with single adjustable support
Miroir agrandisseur à mur 3x avec je supporte flexible
Wand-Vergrößerungsspiegel 3x mit LED-Beleuchtung
Настенное косметическое зеркало с 3-х кратным увеличением на гибком держателе
cm 15 L x 6/18 P x 15 H • Base 5 L x 5 H x 1 P

• 08

€ 170,00



1092

Specchio ingranditore 3x tondo a parete
Wall mounted round enlarging mirror 3x
Miroir agrandisseur 3x round à mur
Runde Wandspiegel mit Vergrößerung 3x
Настенное косметическое зеркало с 3-х кратным увеличением
Cm Ø 20 x 8/18 P • Base Ø 5 x 1 H

• 08 - 23

€ 120,00



23

1091

Specchio ingranditore 3x quadrato a parete
Wall mounted square enlarging mirror 3x
Miroir agrandisseur 3x carré à mur
Quadratisch Wandspiegel mit Vergrößerung 3x
Настенное косметическое зеркало с 3-х кратным увеличением
Cm 20 L x 8 P x 20 H • Base 5 L x 1 P x 5 H

• 08 - 23

€ 130,00



23

POTENZA DI INGRANDIMENTO

MAGNIFICATION POWER / POUVOIR DE GROSSISSEMENT /
MACHT DER VERGRÖSSERUNG / Увеличение мощности

La calotta concava avvicina l'immagine a una distanza che varia dai 30 cm ai 10 cm, a seconda della potenza di ingrandimento dello specchio.

The concave shell approaches the image at a distance ranging from 30 cm to 10 cm, depending on the magnification power of the mirror.

La coque concave s'approche de l'image à une distance allant de 30 cm à 10 cm, en fonction de la puissance d'agrandissement du miroir.

Die konkave Schale nähert sich dem Bild in einem Abstand von 30 cm bis 10 cm, abhängig von der Vergrößerungsstärke des Spiegels.

Вогнутый колпачок приближает изображение на дистанцию от 30 до 10 см, в зависимости от увеличения мощности зеркала.



2X

ingrandisce circa 2 volte a 30 cm di distanza
enlarges about 2 times to 30 cm away
agrandit environ 2 fois à 30 cm
vergrößert sich ca. 2 mal auf 30 cm
увеличение примерно в 2 раза на расстоянии 30 см



3X

ingrandisce circa 3 volte a 25 cm di distanza
enlarges about 3 times to 25 cm away
agrandit environ 3 fois à 25 cm
vergrößert sich ca. 3 mal auf 25 cm
увеличение примерно в 3 раза на расстоянии 25 см



4X

ingrandisce circa 4 volte a 20 cm di distanza
enlarges about 4 times to 20 cm away
agrandit environ 4 fois à 20 cm
vergrößert sich ca. 4 mal auf 20 cm
увеличение примерно в 4 раза на расстоянии 20 см



6X

ingrandisce circa 6 volte a 10 cm di distanza
enlarges about 6 times to 10 cm away
agrandit environ 6 fois à 10 cm
vergrößert sich ca. 6 mal auf 10 cm
увеличение примерно в 6 раз на расстоянии 10 см

Solo su articoli 783 e 1036
only articles 783 and 1036
soulament article 783 et 1036
nur artikel 783 mit 1036
Только арт. 783 и 1036

Solo su articoli 1036 senza illuminazione, stesso prezzo
only articles 1036 without illumination, same price
soulament article 1036 sans éclairage, même prix
nur artikel 1036 ohne Beleuchtung, gleicher Preis
Только арт. 1036 без освещения, одинаковая цена

INGRANDITORI



16

25

36



1037

Specchio ingranditore 3x a parete con supporto snodato singolo
Wall mounted enlarging mirror 3x with single adjustable support
Miroir agrandisseur double visage à mur 3x avec je supporte single
Wand-Vergrößerungsspiegel 3x mit LED-Beleuchtung
Настенное косметическое зеркало с 3-х кратным увеличением на гибком держателе
cm Ø 18 x 24 P • Base Ø 10

• 08	€ 225,00
• 16 - 25 - 36	€ 295,00



25

16

36



489

Specchio ingranditore bifacciale 3x con supporto snodato
Wall mounted double face enlarging mirror 3x with adjustable support
Miroir agrandisseur double visage à mur 3x avec je supporte réglable
Wandspiegel mit Vergrößerung 3x, doppelseitig und klappbar
Настенное косметическое зеркало с 3-х кратным увеличением и поворотным механизмом
cm Ø 18 x 26 L x 40 P max • Base Ø 10

• 08	€ 290,00
• 16 - 25 - 36	€ 370,00



25

16

36



903

Specchio ingranditore bifacciale 3x a parete
Wall mounted double face enlarging mirror 3x
Miroir agrandisseur double visage à mur 3x
Wandspiegel Vergrößerung 3x doppelseitig
Настенное косметическое зеркало с 3-х кратным увеличением и реверсным механизмом
cm Ø 18 x 60 P max x 40 H • INT 18

• 08	€ 330,00
• 16 - 25 - 36	€ 440,00

INGRANDITORI



1096

Specchio ingranditore 3x a parete
Wall-mounted 3x magnifying mirror
Miroir mural grossissant 3x
Wandmontierter 3x Vergrößerungsspiegel
Настенное 3-кратное увеличительное зеркало
cm Ø 20 x 3/22 P max • Base 5 L x 1 P x 13 H

• 08	€ 145,00
------	----------

HQC



1209 DORIAN [DESIGN GIANLUCA PALUDI]

Specchio ingranditore 3x con calamita
3x enlarging mirror with magnet
Miroir agrandisseur 3x avec aimant
Wandspiegel Vergrößerung 3x mit Magnet
3-кратное увеличительное зеркало с магнитом
cm 14 L x 10 P



• 08	€ 110,00
• Piastra specchio / Mirror plate / Plaque de miroir / Spiegelplatte / Зеркальная пластина	€ 14,00

250



905

Specchio ingranditore 3x con calamita
3x enlarging mirror with magnet
Miroir agrandisseur 3x avec aimant
Wandspiegel Vergrößerung 3x mit Magnet
3-кратное увеличительное зеркало с магнитом
cm 15 L x 10 P

• 08	€ 120,00
• Piastra specchio / Mirror plate / Plaque de miroir / Spiegelplatte / Зеркальная пластина	€ 14,00



1075

Specchio ingranditore 3x per specchio da incollo
Glue fixing enlarging mirror 3x for mirror
Miroir agrandisseur 3x par collie pour miroir
Wandspiegel Vergrößerung 3x mit Klebstoff
Увеличительное зеркало 3x с установкой на зеркало
cm Ø 18



• 08	€ 95,00
------	---------

251



1096/2

Specchio ingranditore 3x a parete
Wall-mounted 3x magnifying mirror
Miroir mural grossissant 3x
Wandmontierter 3x Vergrößerungsspiegel
Настенное 3-кратное увеличительное зеркало
cm Ø 20 x 3 x 44 P max • Base 10 L

• 08	€ 169,00
------	----------

HQC

251



23

561

Specchio ingranditore 3x quadrato con base
 Square enlarging mirror 3x with base
 Miroir agrandisseur 3x cadré d'appui
 Quadratischer Standspiegel mit Vergrößerung 3x
 Настольное косметическое зеркало с 3-х кратным увеличением
 cm 16 L x 19 P x 30 H - base 10 x 10

• 08	€ 130,00
• 23	€ 149,00



23

562

Specchio ingranditore 3x rettangolare con base
 Rectangular enlarging mirror 3x with base
 Miroir agrandisseur 3x rectangulaire d'appui
 Rechteckiger Standspiegel mit Vergrößerung 3x
 Настольное косметическое зеркало с 3-х кратным увеличением
 cm 13 L x 9 P x 34 H - base 10 x 10

• 08	€ 135,00
• 23	€ 155,00



23

1092 AP

Specchio ingranditore 3x tondo con base
 Round enlarging mirror 3x with base
 Miroir agrandisseur 3x rond d'appui
 Runder Standspiegel mit Vergrößerung 3x
 3-х круглое увеличительное зеркало с основанием
 cm 13 L x 9 P x 34 H - base 10 x 10

• 08	€ 135,00
• 23	€ 160,00



16

1287

Specchio ingranditore 3x con batteria ricaricabile
 3x magnifying mirror with battery
 Miroir grossissant 3x avec pile
 3x Vergrößerungsspiegel mit Batterie
 3-кратное увеличительное зеркало с батареей
 cm Ø 18,5 x 41 H • Base Ø 12,5

• 08	€ 510,00
• 16	€ 660,00



25



16



36

752

Specchio ingranditore 3x bifacciale con base
 Double face enlarging mirror 3x with base
 Miroir agrandisseur 3x double visage d'appui
 Doppelseitiger Standspiegel mit Vergrößerung 3x
 Настольное косметическое зеркало с 3-х кратным увеличением
 cm Ø 18,5 x 40 H • Base 12,5

• 08	€ 210,00
• 16 - 25 - 36	€ 290,00



EQ 1338

Specchio ingranditore 3x tondo con base
 Round enlarging mirror 3x with base
 Miroir agrandisseur 3x rond d'appui
 Runder Standspiegel mit Vergrößerung 3x
 3-х круглое увеличительное зеркало с основанием
 cm Ø 20 L x 40 H • Base Ø 10

• 08 - 23	€ 290,00
• 18 - 36	€ 390,00





23 25 16 36



1036

Specchio ingranditore 4x da parete con illuminazione LED
Wall monde enlarging mirror 4x with LED light
Miroir agrandisseur à mur 4x avec LED
Schwenkbarer Wand-Vergrößerungsspiegel 4x
Настенное косметическое зеркало с 4-х кратным увеличением и подсветкой
Cm Ø 22 x 26/40P Max H22 • Base Ø 12,5



CE : V 220 12V 4W	
• 08	€ 420,00
• 26 - 16 - 36 - 23	€ 560,00
• Batteria ricaricabile / Muxirrote / xxPlaque iroir / egeplatte / Зеркальная пластина	€ 60,00 +



902

Specchio ingranditore 3x con illuminazione a LED
Wall mounted enlarging mirror 3x with LED light
Miroir agrandisseur à mur 3x avec éclairage à LED
Wandspiegel Vergrößerung 3x mit LED Beleuchtung
Настенное косметическое зеркало с 3-х кратным увеличением и подсветкой
cm Ø 24 x 26/40 P max x 24 H • Base Ø 12 x 2 H



CE : V 220 12V 4W	
• 08	€ 520,00
• 16	€ 620,00
• Batteria ricaricabile / Muxirrote / xxPlaque iroir / egeplatte / Зеркальная пластина	€ 60,00 +



1097

Specchio ingranditore 3x da parete con illuminazione LED
Wall monde enlarging mirror 3x with LED light
Miroir agrandisseur à mur 3x avec LED
Schwenkbarer Wand-Vergrößerungsspiegel 3x
Настенное косметическое зеркало с 3-х кратным увеличением и подсветкой
Cm Ø 21 x 39 P • Base Ø 12

HQC



CE : V 220 12V 4W	
• 08	€ 295,00
• 23	€ 330,00



901

Specchio ingranditore 3x con illuminazione a LED
Wall mounted enlarging mirror 3x with LED light
Miroir agrandisseur à mur 3x avec éclairage à LED
Wandspiegel Vergrößerung 3x mit LED Beleuchtung
Настенное косметическое зеркало с 3-х кратным увеличением и подсветкой
cm 22 L x 25/39 P x 22 H • Base 12 L x 12 P x 2,5 H



CE : V 220 12V 4W	
• 08	€ 590,00



1252

Specchio ingranditore calamitato con illuminazione LED
Magnetised magnifying mirror with LED lighting
Miroir grossissant magnétisé avec éclairage LED
Magnetischer Vergrößerungsspiegel mit LED-Beleuchtung
Магнитическое увеличительное зеркало со светодиодной подсветкой
Cm Ø 21 x 39 P • Base Ø 12



CE : V 220 12V 4W	
• 08	€ 340,00
• piastra specchio	€ 14,00



25

1282

Specchio ingranditore a soffietto con batteria ricaricabile
Folding magnifying mirror with rechargeable battery
Miroir grossissant pliable avec batterie rechargeable
Faltbarer Vergrößerungsspiegel mit wiederaufladbarem Akku
Складное увеличительное зеркало с аккумулятором
cm 22 L x 39 P x 22 H • Base 12 L x 12 P x 2,5 H



CE : V 220 12V 4W	
• 08	€ 590,00
• 16 - 25 - 36	€ 730,00



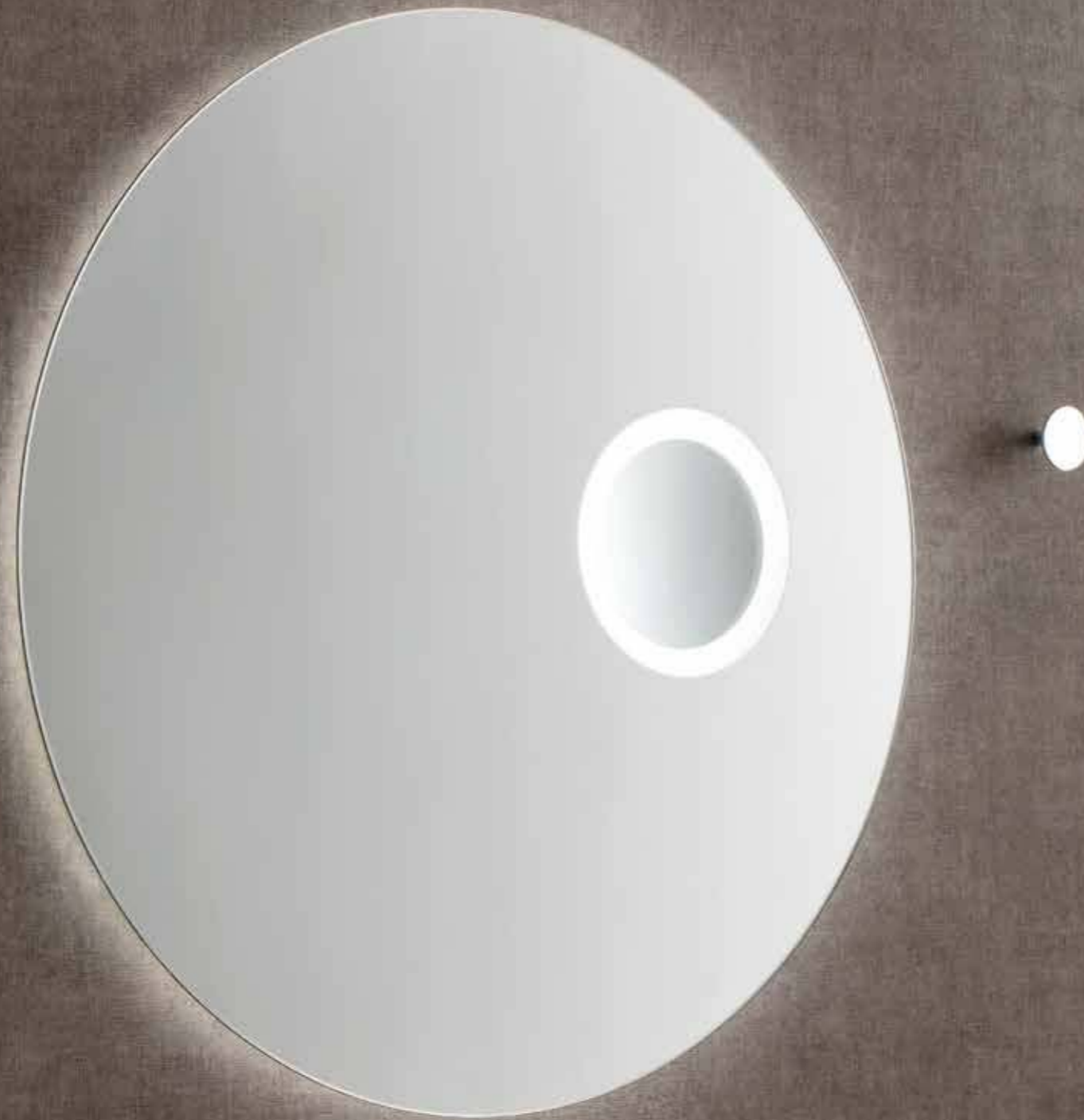

1065

Specchio filo lucido con ingranditore 3x
 Rectangular mirror with enlarging mirror 3x
 Miroir rectangulaire avec miroir agrandisseur 3x
 Rechteckiger Wandspiegel mit Vergrößerung 3x
 зеркало с LED подсветкой и 3-х кратным
 увеличением
 cm 112 L x 64 H - ING. Ø 21

€ 440,00

D 1 3



1140

Specchio filo lucido con ingranditore 3x
 illuminazione LED
 Rectangular mirror with enlarging mirror 3x LED
 Miroir rectangulaire avec miroir agrandisseur 3x LED
 Rechteckiger Wandspiegel mit Vergrößerung 3x LED
 зеркало с LED подсветкой и 3-х кратным
 увеличением
 cm 112 L x 64 H - ING. Ø 21
 CE : V 220 12V 4W

€ 620,00

D 1 3



1289

Specchio filo lucido con ingranditore 3x
 Polished wire mirror with 3x magnification
 Miroir en fil poli avec grossissement 3x
 Polierter Drahtspiegel mit 3-facher Vergrößerung
 Полированное проволочное зеркало с
 увеличением 3x
 cm Ø 80 - ING. Ø 21

€ 490,00

D 1 4



1290

Specchio filo lucido con ingranditore 3x
 illuminazione LED
 Polished wire mirror with 3x magnification and
 LED lighting
 Miroir en fil poli avec grossissement 3x et
 éclairage LED
 Polierter Drahtspiegel mit 3-facher
 Vergrößerung und LED-Beleuchtung
 Полированное проволочное зеркало с
 увеличением 3x и светодиодной подсветкой
 cm Ø 80 - ING. Ø 21
 CE : V 220 12V 4W

€ 690,00

D 1 4



599

Specchio ad angolo con contenitore in acciaio inox
 Corner mirror with container in stainless steel
 Miroir à angle avec conteneur en acier inox
 Eck Spiegelschrank Edelstahl
 Зеркальный шкаф угловой из нержавеющей стали
 cm 41 L x 30 P x 80 H

• filo lucido/shine edge/bord brillant
 glänzender Rand / провод полированный € 380,00



606

Specchio con contenitore in acciaio inox
 Mirror with container in stainless steel
 Miroir avec conteneur en acier inox
 Spiegelschrank Edelstahl
 Зеркальный шкаф из нержавеющей стали
 cm 45 L x 14 P x 62 H

• filo lucido/shine edge/bord brillant
 glänzender Rand / провод полированный € 330,00



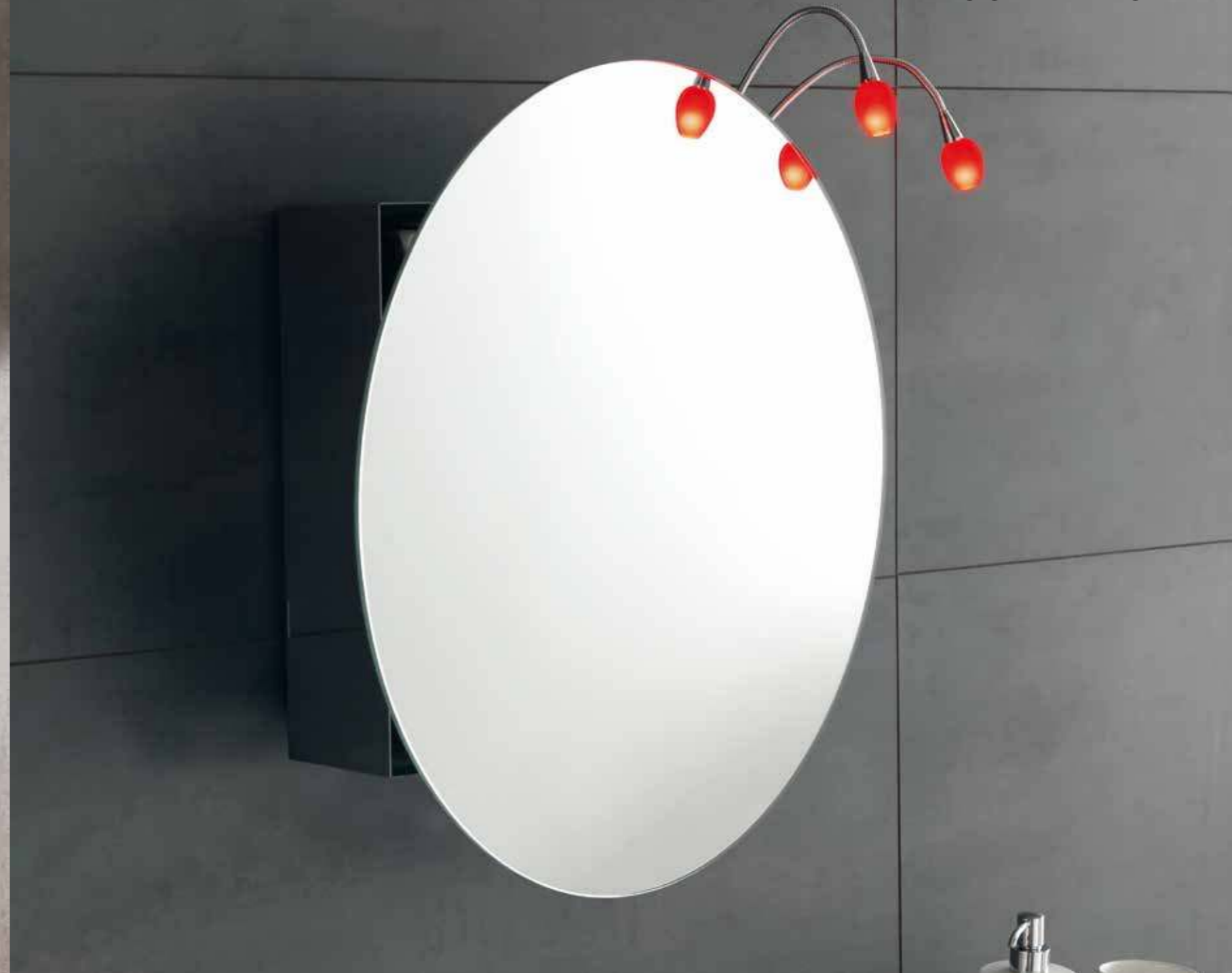

1291

Specchio con contenitore in acciaio inox
Mirror with container in stainless steel
Miroir avec conteneur en acier inox
Spiegelschrank Edelstahl
Зеркальный шкаф из нержавеющей стали
cm 50 L x 14 P x 90 H

• filo lucido/shine edge/bord brillant /
glänzender Rand / провод полированный € 360,00



550

Specchio con contenitore in acciaio inox
Mirror with container in stainless steel
Miroir avec conteneur en acier inox
Spiegelschrank Edelstahl
Зеркальный шкаф из нержавеющей стали
cm Ø 60 x 14 P

• filo lucido/shine edge/bord brillant /
glänzender Rand / провод полированный € 320,00





23 08



Specchio con cornice cromata reversibile
Reversible mirror with chromed frame
Miroir avec cadre chrome réversible
Spiegel mit verchromtem Rand
Прямоугольное зеркало
Reversibile

• 678	cm 50 x 70	• 08 - 23	€ 135,00
• 679	cm 50 x 90	• 08 - 23	€ 145,00



Specchio rettangolare filo lucido reversibile
Reversible rectangular mirror with shine edge
Miroir rectangulaire avec bord brillant réversible
Rechteckiger Spiegel mit glänzendem Rand
Прямоугольное зеркало
Reversibile

• 1319	cm 60x80	€ 135,00
• 1324	cm 70x90	€ 140,00
• 1320	cm 70x120	€ 185,00





1073

Specchio con mensola
Cut mirror with shelf
Miroir coupé avec étagère
Geformter Spiegel
Декоративное зеркало
cm 50 L x 12 P x 70 H

• filo lucido/shine edge/bord brillant/
glänzender Rand / провод полированный € 270,00



RETTANGOLO

Specchio con LED perimetrale
Mirror with diffused led light
Miroir avec led lumière diffusée
Spiegel mit LED Hinterleuchtung
Прямоугольное зеркало с внутренней
подсветкой и алюминиевым обрамлением
Reversibile

CE LED 13 W V 220 IP44

• 1319 LED	cm 60x80	€ 280,00
• 1159	cm 50x90	€ 290,00
• 1324 LED	cm 70x90	€ 310,00
• 1320 LED	cm 70x120	€ 360,00



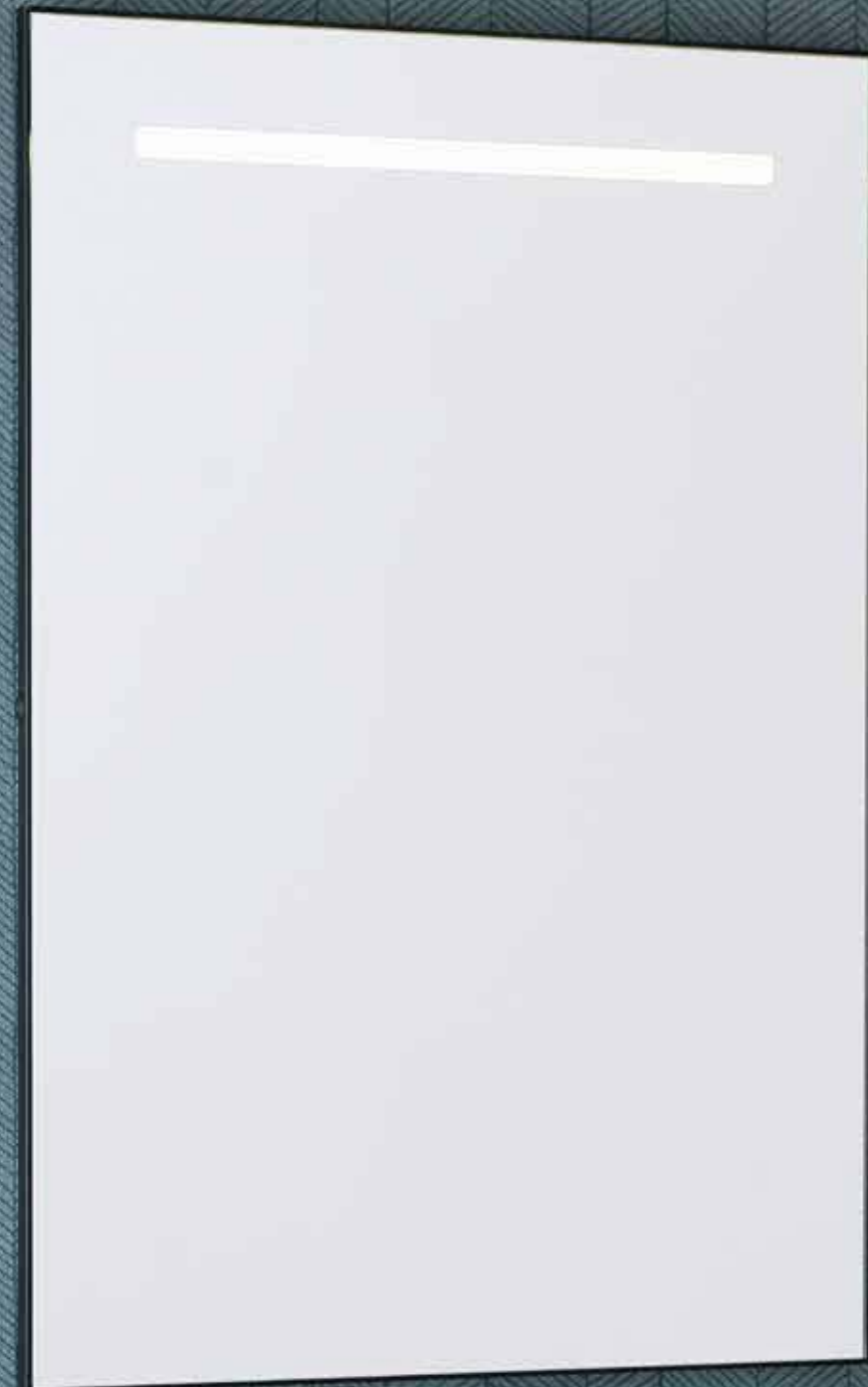

842

Specchio Retroilluminato LED, con cornice cromata
 Mirror with LED light, chrome aluminium frame
 Miroir avec LED lumière, cadre en aluminium Chromé
 Spiegel mit LED Hinterleuchtung und Halterung aus Chrom
 Зеркало с подсветкой, с хромированной алюминиевой раме
 cm 60 L x 90 H
 CE: LED - 9W - V220 - IP21

• 08 - 23 € 340,00



948

Specchio retroilluminato LED, cornice cromata, luce diffusa in alto/basso
 Mirror with diffused led light, chrome aluminium frame
 Miroir avec led lumière diffuse, cadre en aluminium Chromé
 Spiegel mit LED-Beleuchtung (diffus) und Halterung aus Chrom
 Зеркало с подсветкой, с хромированной алюминиевой раме, рассеянный свет
 cm 90 L x 70 H
 CE: LED - 13+8,6 W - V220 - IP21

• 08 - 23 € 440,00



1210

Specchio retroilluminato con 8 spot led, con cornice cromata
 Backlit mirror with 8 led spots, with chromed frame
 Miroir rétro-éclairé avec 8 spots LED, avec cadre chromé
 Von hinten beleuchteter Spiegel mit 8 LED-Spots, mit verchromtem Rahmen
 Зеркало с подсветкой с 8 светодиодными точками, с хромированной рамой
 cm 90 L x 70 H
 CE: LED - 3x3,5W - V220 - IP21

• 08 € 440,00



1115

Specchio Retroilluminato LED, con cornice cromata
 Mirror with LED light, chrome aluminium frame
 Miroir avec LED lumière, cadre en aluminium chromé
 Spiegel mit LED Hinterleuchtung und Halterung aus Chrom
 Зеркало с подсветкой, с хромированной алюминиевой рамой
 cm 90 L x 70 H
 CE: LED - 19,2W - V220 - IP21

• 08 - 23 € 410,00



1175/1308

Specchio retroilluminato, luce cost to cost
 Mirror with led light cost to cost
 Miroir avec led lumiere cost to cost
 Hinterleuchteter Spiegel, Kosten für Licht
 Зеркало с подсветкой, стоимость света

CE: Led 7 W - V 220 - IP21

1175 cm 30 L x 70 H • 08 - 23 € 320,00
 1308 cm 50 L x 90 H • 08 - 23 € 520,00



1139

Specchio Retroilluminato LED, con cornice cromata
 Mirror with LED light, chrome aluminium frame
 Miroir avec LED lumiere, cadre en aluminium Chromé
 Spiegel mit LED Hinterleuchtung und Halterung
 aus Chrom

Зеркало с подсветкой, с хромированной
 алюминиевой раме

cm 70 L x 90 H
 CE: Led 28 W - V 220 - IP21

• 08 € 390,00





1066

Specchio Retroilluminato LED, con fasce satinare
 Mirror with LED light
 Miroir avec LED lumière
 Spiegel mit LED Hinterleuchtung
 Зеркало с подсветкой
cm 60 x 80 • Reversibile
 CE: Led 15 W - V 220 - IP21

• 08 € 370,00



1192

Specchio con Led perimetrale e sabbiatura cm 4
 Mirror with perimeter LED and sandblasting 4 cm
 Miroir avec périmètre LED et sablage 4 cm
 Spiegel mit Perimeter LED und Sandstrahlen 4 cm
 Зеркало по периметру Светодиодный и пескоструйный см 4
cm 70 x 90 • Reversibile
 CE: Led 28 W - V 220 - IP44

€ 390,00

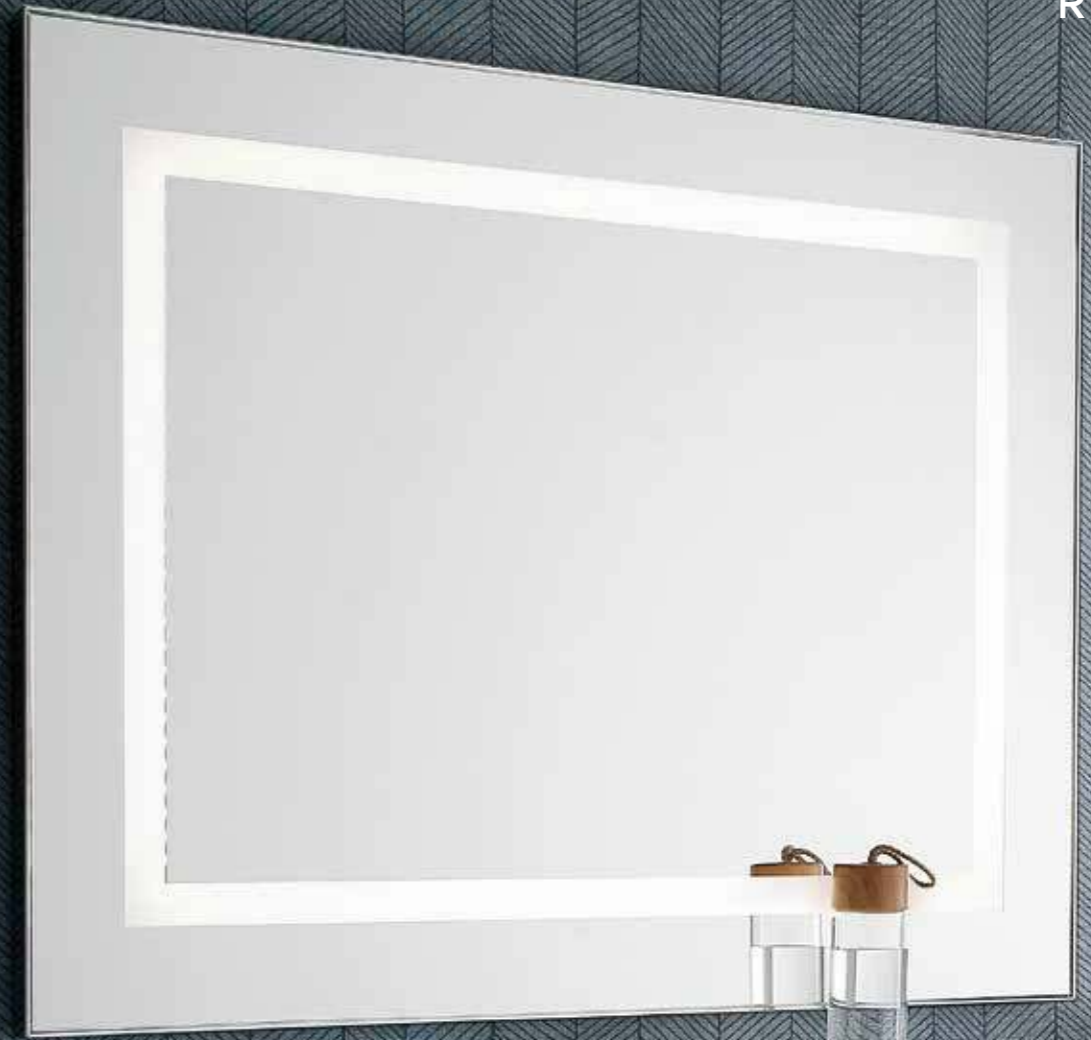

1041

Specchio con LED perimetrale
 Mirror with diffused led light
 Miroir avec led lumiere diffused
 Spiegel mit LED Hinterleuchtung
 Прямоугольное зеркало с внутренней
 подсветкой и алюминиевым обрамлением
cm 80 x 100 • Reversibile
 CE: Led 26 W - V 220 - IP21

€ 410,00



1193

Specchio con sabbiatura interna da 3 cm
 Mirror with internal sandblasting
 Miroir sablage interne de 3 cm
 Spiegel internem Sandstrahlen
 Зеркало по периметру Светодиодное и 3 см
 внутренняя пескоструйная обработка
cm 70 x 90 • Reversibile
 CE: Led 28 W - V 220 - IP44

• 08

€ 440,00

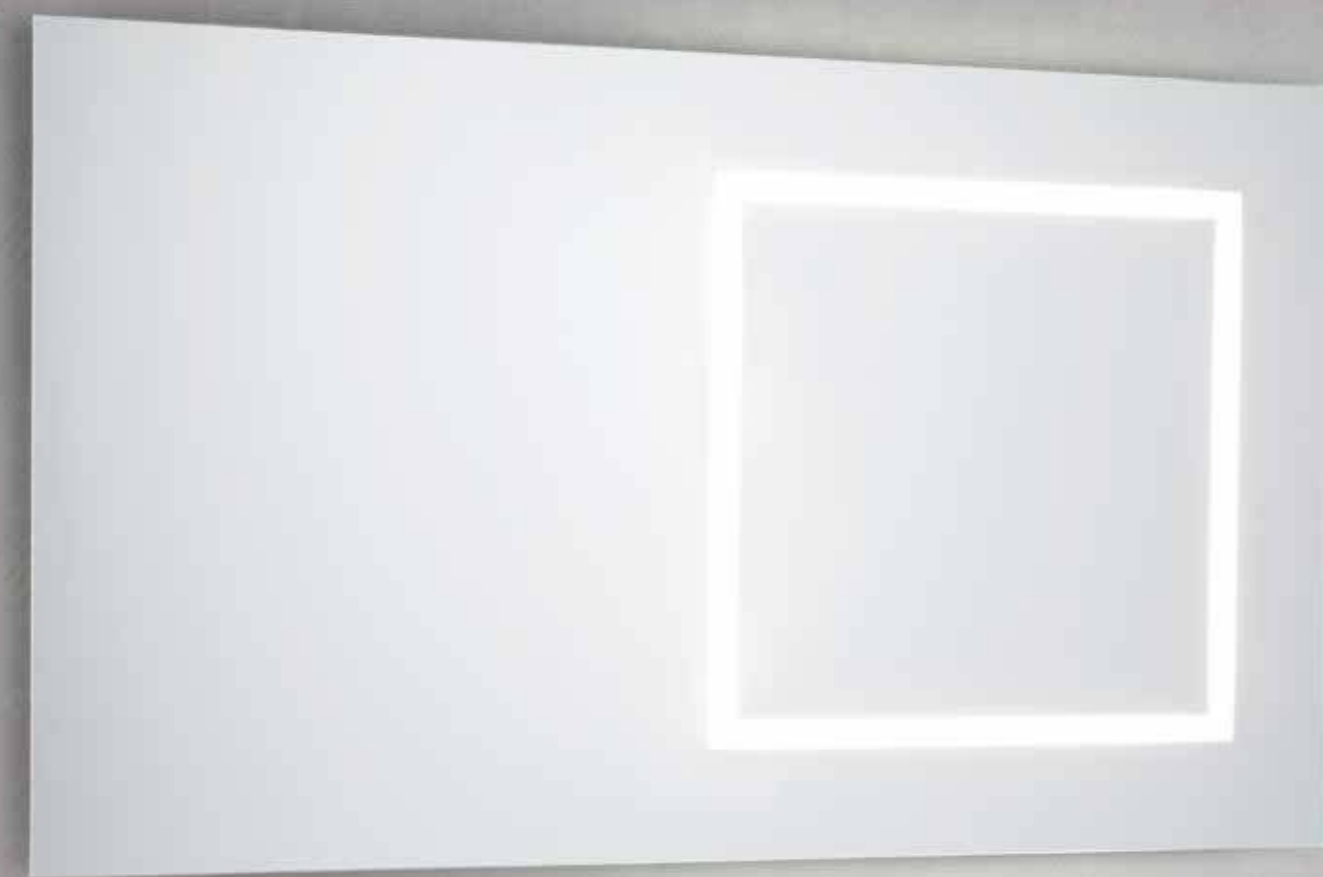
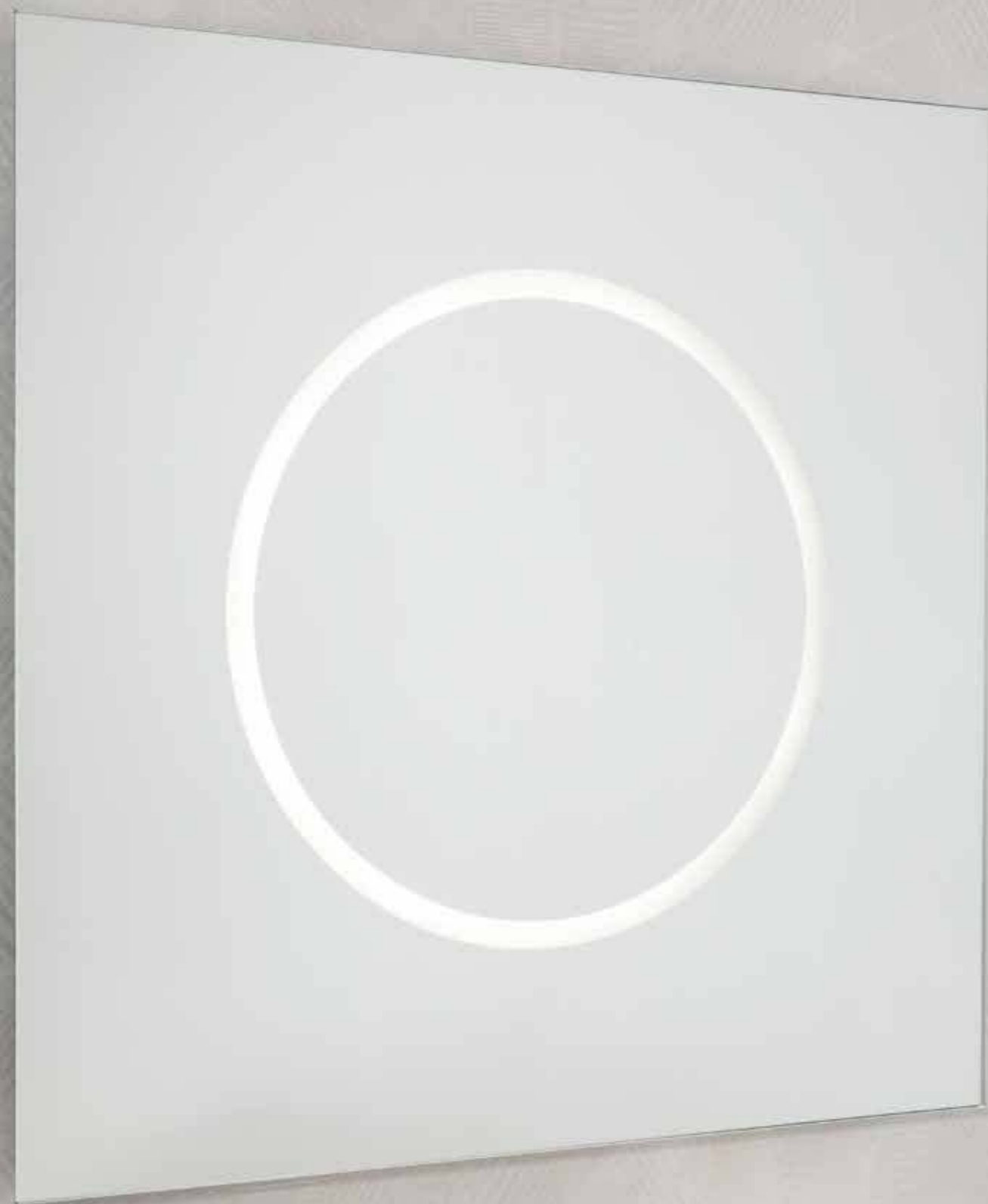

1339

Specchio con sabbiatura interna 2cm
 Mirror with internal sandblasting 2cm
 Miroir avec sablage interne 2cm
 Spiegel mit interner Sandstrahlung 2cm
 Зеркало с внутренним пескоструйным
 рисунком 2см
 cm 80 L x 80 H
 CE: LED - 14 W - V220 - IP44



1340

Specchio con sabbiatura interna 2cm
 Mirror with internal sandblasting 2cm
 Miroir avec sablage interne 2cm
 Spiegel mit interner Sandstrahlung 2cm
 Зеркало с внутренним пескоструйным
 рисунком 2см
 cm 70 L x 120 H
 CE: LED - 16 W - V220 - IP44



€ 460,00

€ 490,00



Specchio rotondo
Round mirror
Miroir rond
Runder Spiegel
Круглое зеркало



• 497	Ø 50	€ 95,00
• 1113	Ø 60	€ 155,00
• 1114	Ø 70	€ 165,00
• 1170	Ø 80	€ 195,00
• 1190	Ø 90	€ 235,00



Specchio rotondo con LED perimetrale
Round mirror with diffused led light
Miroir round avec led lumiere diffused
Runder spiegel mit LED Hinterleuchtung
Прямоугольное зеркало с внутренней
подсветкой и алюминиевым обрамлением



CE: Led 26 W - V 220 - IP21		
• 1118	Ø 70	€ 340,00
• 1191	Ø 80	€ 370,00
• 1179	Ø 90	€ 420,00





1356



Specchio rotondo con LED perimetrale e sabbatura da 3 cm

Round mirror with perimeter LED lighting and 3 cm sandblasting

Miroir rond avec éclairage LED périphérique et sablage de 3 cm

Runder Spiegel mit umlaufender LED-Beleuchtung und Sandstrahlen von 3 cm

Круглое зеркало с периметральной подсветкой LED и пескоструйной обработкой 3 cm

CE: Led 26 W - V 220 - IP21

€ 480,00



1285



Specchio retroilluminato con punti led

Backlit mirror with LED dots

Miroir rétro-éclairé avec points LED

Hintergrundbeleuchteter Spiegel mit LED-Punkten

Зеркало с подсветкой и светодиодными точками

cm Ø 80

CE: LED - 15 W - V220 - IP21

€ 620,00

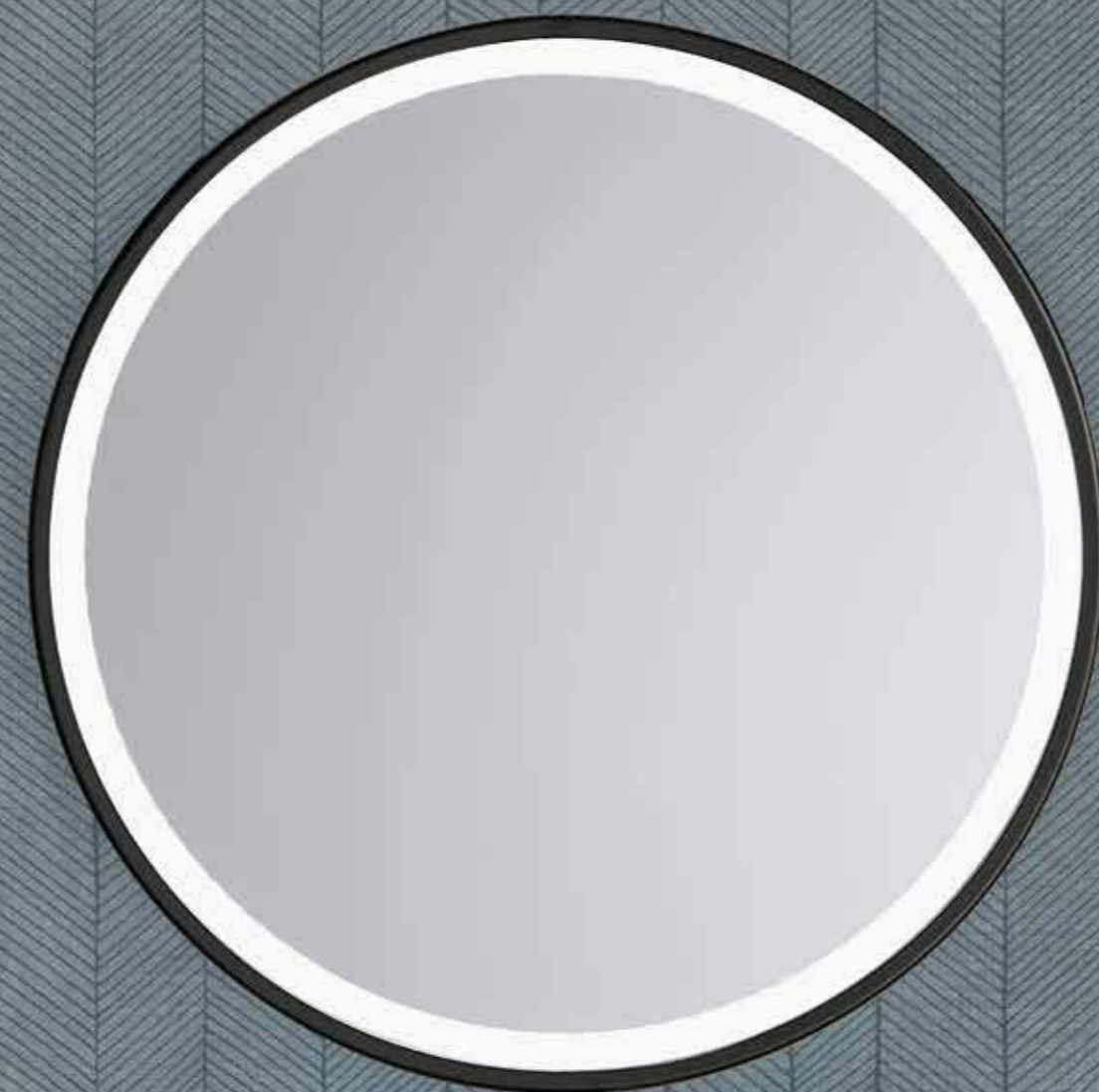

1227

Specchio tondo con metallo e retroilluminazione
 Round mirror with metal and backlighting
 Miroir rond avec métal et rétro-éclairage
 Runder Spiegel mit Metall und Hintergrundbeleuchtung
 Круглое зеркало с металлической и подсветкой

CE: LED - 13 W - V220 - IP21

- 1227.60 Ø 60 • 23 € 490,00
- 1227.60 Ø 60 • 27-18 € 580,00
- 1227.80 Ø 80 • 23 € 610,00
- 1227.80 Ø 80 • 27-18 € 720,00



27



18

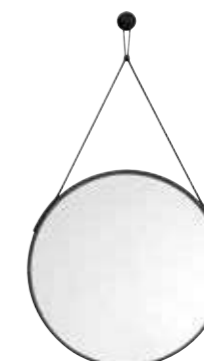

1212

Specchio con cintura in cuoio
 Mirror with leather belt
 Miroir avec ceinture en cuir
 Spiegel mit Ledergürtel
 Зеркало с кожаным ремнем

P3,5 x H115/110

- 1212.60 Ø 60 € 195,00
- 1212.80 Ø 80 € 250,00

**1341**

Specchio sagomato con LED perimetrale
Contoured mirror with perimeter LED
Miroir profilé avec LED périphérique
Konturierter Spiegel mit umlaufender LED
Контурное зеркало со светодиодам по периметру
cm 120 L x 105 H x 80 B
CE: LED - 16 W - V220 - IP44

€ 550,00

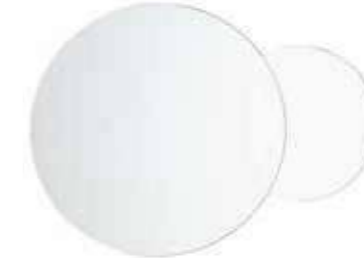
**1178 BI-BUBLE**

Specchi tondi sovrapposti con LED perimetrale
Round mirrors superimposed with perimeter LED
Runde Spiegel, die mit einer LED überlagert sind
Складные круглые зеркала со светодиодами по периметру
cm 115 L x 80 H
CE: Led 16 W - V 220 - IP44

• filo lucido/shine edge/bord brillant/glänzender Rand / провад полированный € 440,00
• con led perimetrale /with diffused led light / avec led lumiere diffused / mit led Hinterleuchtung / LED периметру c € 610,00



**1969 - FASE**

Specchio in 2 parti con led perimetrale
 Two-part mirror with perimeter LED lighting
 Miroir en 2 parties avec éclairage LED périphérique
 Zwei-teiliger Spiegel mit LED-Randbeleuchtung
 Зеркало из двух частей с периметральной
 светодиодной подсветкой
 cm 90 L x 111 H + 69 L x 29 H
 TOP cm 30 H - Sifone 55 H
 CE: Led 20 W - V 220 - IP44

• SX	€ 1300,00
• DX	€ 1300,00

**1311 - ORBITA**

Specchio con led perimetrale
 Mirror with perimeter LED lighting
 Miroir avec éclairage LED périphérique
 Spiegel mit randseitiger LED-Beleuchtung
 Зеркало с периметральной светодиодной
 подсветкой
 cm 95/124 L x 124 H
 CE: Led 15 W - V 220 - IP44

• SX	€ 590,00
• DX	€ 590,00

**LV 01**

Specchio sagomato
Cut mirror
Miroir coupé
Geformter Spiegel
Декоративное зеркало
cm 50 L x 90 H

CE: LED - 26 W - V220 - IP21

- filo lucido/shine edge/bord brillant / glänzender Rand / провод полированный € 270,00
- con led perimetrale /with diffused led light / avec led lumiere diffusé / mit led Hinterleuchtung / LED периметру с € 390,00

**1208 DORIAN [DESIGN GIANLUCA PALUDI]**

Specchio sagomato
Cut mirror
Miroir coupé
Geformter Spiegel
Декоративное зеркало
cm 86 x 86 • Reversibile

CE: LED - 26 W - V220 - IP21

- filo lucido/shine edge/bord brillant / glänzender Rand / провод полированный € 270,00
- con led perimetrale /with diffused led light / avec led lumiere diffusé / mit led Hinterleuchtung / LED периметру с € 410,00
- 1209 - Specchio ingranditore calamitato € 110,00





1262

Specchio sagomato con LED perimetrale
Contoured mirror with perimeter LED
Miroir profilé avec LED périphérique
Konturierter Spiegel mit umlaufender LED
Контурное зеркало со светодиодом по периметру

cm 100 x 50 • Reversibile

CE: LED - 13 W - V220 - IP21

• filo lucido/shine edge/bord brillant/glänzender Rand / провод полированный € 340,00

• con led perimetrale with diffused led light / avec led lumiere diffusée mit led Hinterleuchtung / LED периметру с € 440,00



1261

Specchio sagomato con LED perimetrale
Contoured mirror with perimeter LED
Miroir profilé avec LED périphérique
Konturierter Spiegel mit umlaufender LED
Контурное зеркало со светодиодом по периметру

cm 70 L x 70 H

CE: LED - 13 W - V220 - IP21

• filo lucido/shine edge/bord brillant/glänzender Rand / провод полированный € 290,00

• con led perimetrale with diffused led light / avec led lumiere diffusée mit led Hinterleuchtung / LED периметру с € 400,00



**1326**

Specchio sagomato a soffitto
Shaped ceiling mirror
Miroir façonné au plafond
Geformter Deckenspiegel
Формированное потолочное зеркало
cm 50 L x 90 / 160 H

- 08 - 23 filo lucido/shine edge/bord brillant/
glänzender Rand / провод полированный € 400,00
- 08 - 23 con led perimetrale
with diffused led light / avec led lumiere
diffused mit led Hinterleuchtung / LED
периметру с € 550,00

**1194****FOLD**

Specchio con ante orientabili doppie
Mirror with double adjustable light
Miroir avec double lumière réglable
Spiegel mit doppelt verstellbarem Licht
Зеркало с двойной регулируемой подсветкой
cm 80/106 L x 70 H

- 1194 CE: LED - 19,2W - V220 - IP21 € 590,00
- 1194 SL no LED € 390,00

1194 SL

**1355**

Specchio rettangolare molato
Cut ovale mirror with grind
Miroir ovale coupé avec meulage
Ovaler Spiegel mit Facettenschliff
Овальное зеркало

cm 70 x 90 • Reversibile

€ 290,00

**O 01**

Specchio ovale molato
Cut ovale mirror with grind
Miroir ovale coupé avec meulage
Ovaler Spiegel mit Facettenschliff
Овальное зеркало

cm 65 x 90 • Reversibile

€ 270,00

**D I 4****D I 4**

**798**

Specchio tondo con molatura a bastone
 Cut round mirror with grind
 Miroir coupé avec meulage
 Runder Spiegel mit Rundschliff
 Круглое зеркало
 cm Ø 70

€ 350,00

**563**

Specchio sagomato con molatura a bastone
 Cut mirror with grinding
 Miroir coupé avec meulage
 Geformter Spiegel mit Rundschliff
 Овальное зеркало
 cm 70 L x 90 H

€ 350,00





968

Specchio molato e inciso
 Bavelled mirror and engraved
 Miroir avec meulage et gravée
 Spiegel mit geätzten Rundschliff
 зеркало скошенные травленое
 cm 70 L x 90 H

€ 340,00

D I 4

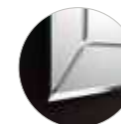

906

Specchio rettangolare con molatura a bastone
 Cut rectangular mirror with grind
 Miroir rectangulaire avec meulage
 Rechteckiger Spiegel mit Rundschliff
 Овальное зеркало
 cm 65 L x 90 H

€ 340,00

D I 4



**R 01.03**

Specchio sagomato molato
Cut mirror with grind
Miroir coupé avec meulage
Geformter Spiegel mit Schliff
Зеркало скошенное

cm 60 L x 80 H

€ 320,00

**G 698 GIUNONE**

Specchio attrezzato come foto
Equipped mirror same photo
Miroir équipé comme photo
Spiegel mit Ablage und Beleuchtung
Зеркало с латунной рамой с полкой

cm 70 L x 95 H

• 08 € 650,00
• 16 - 25 - 36 € 770,00

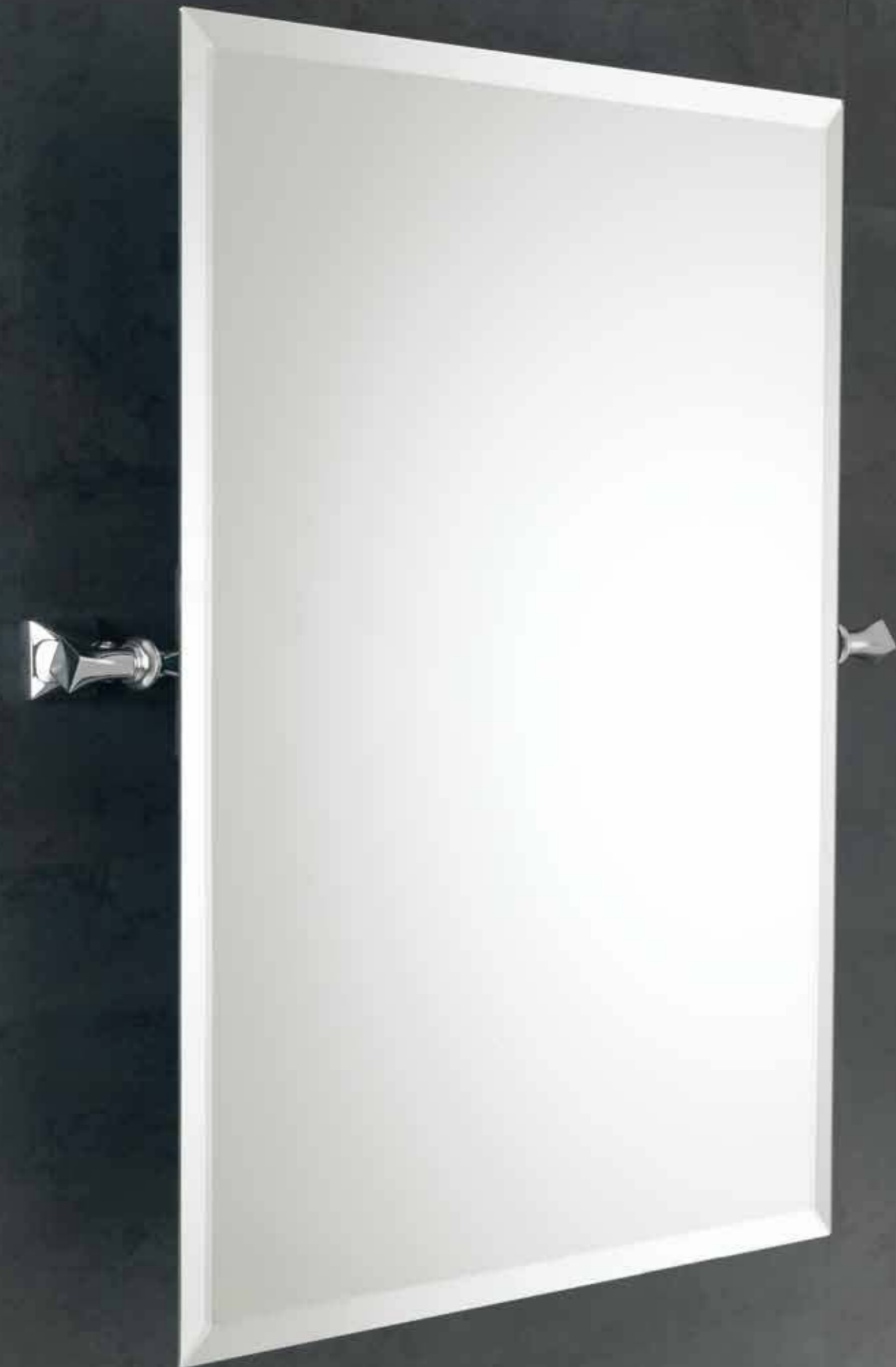
**PR 01 PRISMA**

Specchio molato orientabile
Adjustable and grind mirror
Miroir réglable avec meulage
Justierbare Spiegel mit Rundschiiff
зеркало скошенные регулируемый
cm 63 L x 70 H x 10 P

• 08	€ 340,00
• 16 - 25 - 36	€ 400,00

**EL 01 ELITE**

Specchio molato orientabile
Adjustable and grind mirror
Miroir réglable avec meulage
Justierbare Spiegel mit Rundschiiff
зеркало скошенные регулируемый
cm 63 L x Ø 50 x 10 P

• 08	€ 320,00
• 16 - 25 - 36	€ 380,00



005
ORO
Gold
Or
Gold
золото

06
ARGENTO
Silver
Argent
Silber
серебро

specchio con cornice foglia argento cm 10 - oro, prezzo al cml: € 1,45
mirror with frame silver - gold leaf, price per lcm
miroir avec cadre feuille d'argent - d'or, prix par cml
Spiegel mit Rahmen Silber - Gold Blatt, Preis pro lfd cm
Багетное зеркало лист серебро - золото, Цена за сантиметр

ESEMPIO
EXAMPLE / EXEMPLE / BEISPIEL / Пример
RIF AR cm 70 L - 90 H = cm 320 x € 1,35 = € 464,00



OR
ORO
Gold
Or
Gold
золото

AR
ARGENTO
Silver
Argent
Silber
серебро

08
NERO
Black
Noir
Schwarz
черный

33
BIANCO
White
Blanc
Weiß
белый

specchio con cornice laccato bianco cm 9 - nero, prezzo al cml: € 2,25
mirror with frame white - black lacquered, price per lcm
miroir avec cadre laqué blanc - noir, prix par cml
Spiegel mit Rahmen Weiß - Schwarz lackiert, Preis pro lfd cm
Багетное зеркало лаковый белый - черный, Цена за сантиметр

specchio con cornice foglia argento cm 9 - oro, prezzo al cml: € 2,10
mirror with frame silver - gold leaf, price per lcm
miroir avec cadre feuille d'argent - d'or, prix par cml
Spiegel mit Rahmen Silber - Gold Blatt, Preis pro lfd cm
Багетное зеркало лист серебро - золото, Цена за сантиметр

ESEMPIO
EXAMPLE / EXEMPLE / BEISPIEL / Пример
RIF P 33 cm 70 L - 90 H = cm 320 x € 2,15 = € 720,00
RIF G AR cm 70 L - 90 H = cm 320 x € 1,95 = € 672,00







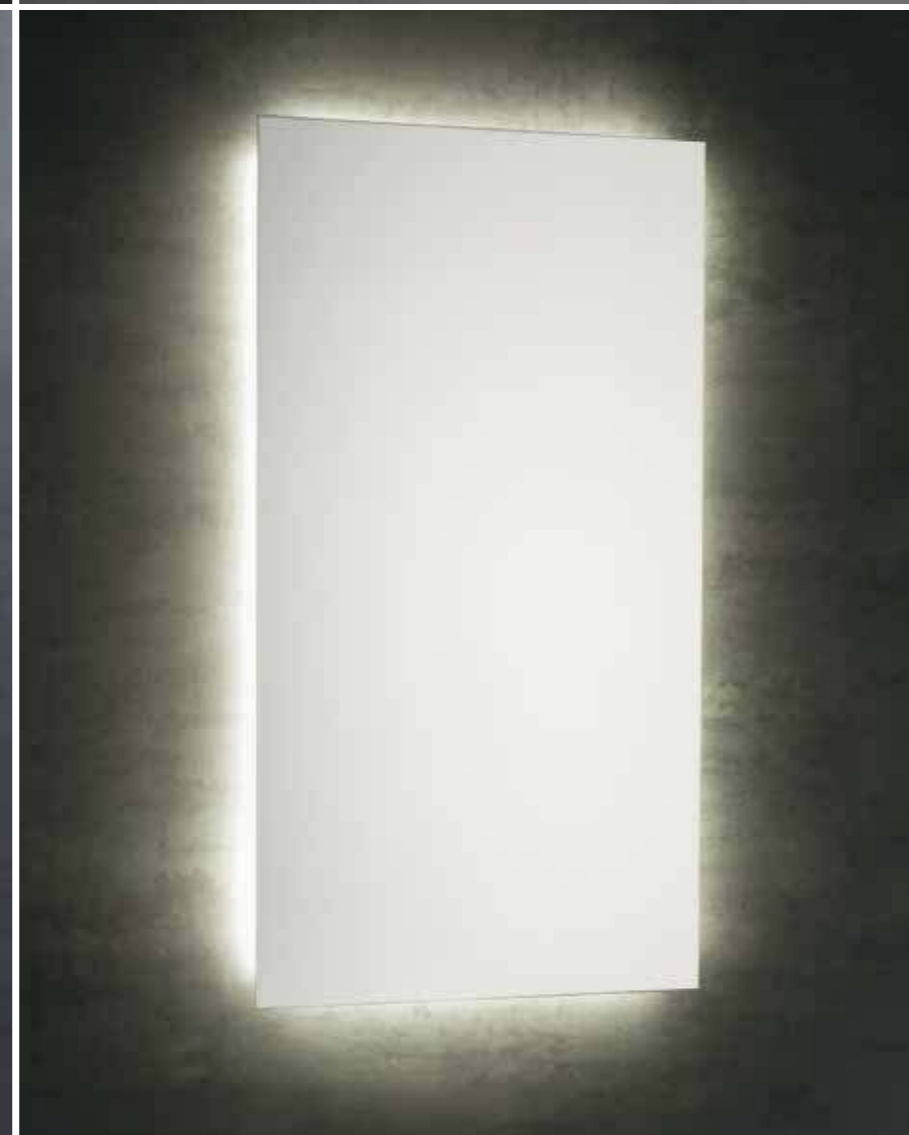
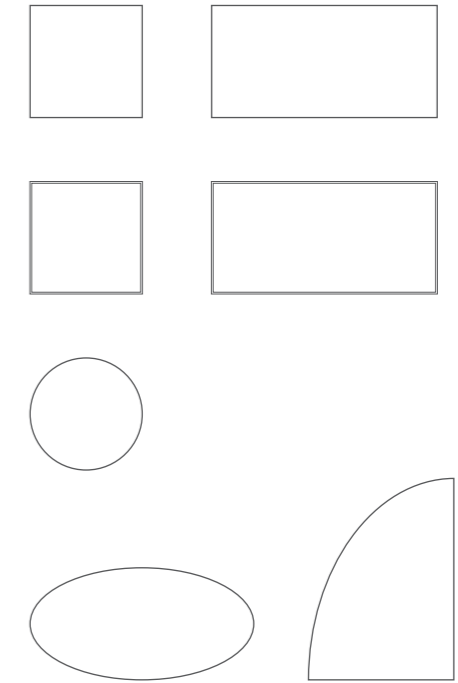

SPECCHI SU MISURA

MIRROR ON MEASURE / MIROIRS SUR MEASURE / MIT GLÄNZENDEM RAND/ зеркала под заказ







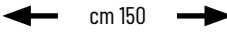

- 1 VETRO a filo lucido (indicare L x H): € 250,00 (per mq) 20 - 220 cm
GLASS with shine edge (indicate L x H): € 250,00 (for mq)
VERRE bord brillant (indiquer L x H): € 250,00 (pour mq)
GLAS mit glänzendem rand (zeigen L x H): € 250,00 (pro mq)
стекло с полированными краями (государственныйШхВ): € 250, 00 (за кв.м.)
- 2 VETRO molato cm 1 (indicare L x H): € 330,00 (per mq) 20 - 220 cm
GLASS Grind cm 1 (indicate L x H): € 330,00 (for mq)
VERRE Meulage cm 1 (indiquer L x H): € 330,00 (pour mq)
GLAS Facettenschliff cm 1 (zeigen L x H): € 330,00 (pro mq)
стекло земля 1 см (Ш x В): указывающие € 330, 00 (за кв.м.)
- 3 VETRO tondo filo lucido € 260,00 per diametro 30 - 150 cm
GLASS round with shine edge: € 260,00 (for DIAMETR)
VERRE bord brillant (indiquer L x H): € 260,00 (pour diamètre)
GLAS mit glänzendem Rand (zeigen L x H): € 260,00 (pro durchmesser)
стекла круглой формы € 260,00 за диаметр
- 4 VETRO sagomato filo lucido € 480,00 (per mq)
Shaped glass with polished edge, €480,00 (for mq)
Verre façonné avec bord poli, 480,00 € (pour mq)
Geschliffenes Glas mit poliertem Rand, 480,00 € (pro mq)
Фигурное стекло с полированным краем, 480,00 € (за кв.м.)





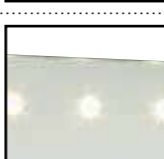

FISSAGGI PER SPECCHI NON RETROILLUMINATI/ FIXING FOR MIRROR WITHOUT LED BACKLIGHTED/ CHÂSSIS POUR MIROIRS SANS RÉTRO-ÉCLAIRAGE/ Rahmen für Spiegel ohne LED-integrierte/ Крепеж для зеркал без светодиодной подсветки

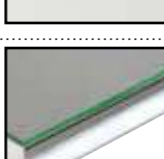

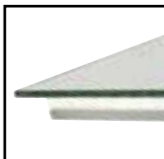

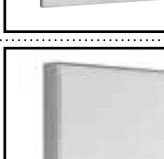
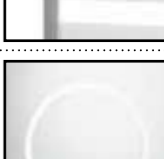

	ESEMPIO EXAMPLE / EXEMPLE BEISPIEL / Пример		
• B) Solo telaio inox lucido, mm 26 Only frame mm 26 Seulement cadre mm 26 Rahmen Edelstahl poliert Только 26 мм полированная рама из нержавеющей стали	1 + B	[maggiorazione] € 80,00 supplément supplément Aufpreis дополнение	583 
• D) Cornice cromata, mm 25 Chromed frame mm 25 Cadre Chrome mm 25 Rahmen Verchromt mm 25 Хромовый остов 25 мм	1 + D	[maggiorazione] € 95,00 supplément supplément Aufpreis дополнение	678 
• Z) Cornice nero opaco, mm 25 Chromed frame mm 25 Cadre Chrome mm 25 Rahmen Verchromt mm 25 Хромовый остов 25 мм	1 + Z	[maggiorazione] € 95,00 supplément supplément Aufpreis дополнение	678 
• E) Per specchi con lato superiore cm 150 L For mirrors biggest than cm 150 L Pour miroir avec une longueur supérieure à cm 150 Spiegel ab 150 cm Länge для зеркала свыше 150 L доплата	1 + B + E	[maggiorazione] € 80,00 supplément supplément Aufpreis дополнение	← cm 150 → 

ESEMPIO
EXAMPLE / EXEMPLE
BEISPIEL / Пример

• O)	Impianto o cornice cromo o nero, per specchi con luce LED - OBLIGATORIO Plant and frame for mirrors with only perimeter light - OBLIGATORY Plante et cadre de miroirs avec seulement la lumière de périmètre - OBLIGATOIRE Halterung und Rahmen für Spiegel mit Umrandungsbeleuchtung - OBLIGATORISCH Машины и рама зеркала с только легкой периметру	1+0+	[maggiorazione] € 140,00 supplement supplément Aufpreis дополнение	842 / 1159	
• F)	Retroilluminati sabbiatura cm 50 max, led 10 W Backlit mirrors, frame, frosted glass cm 50 max, led 10 W Miroirs avec la lumiere, cadre, en verre dépoli cm 50 max, led 10 W Spiegel mit integrierter LED-Leuchte, Rahmen verchromt Milchglas cm 50 max, led 10 W Подсветка Chrome Frame, взрывные 50 см макс, 10 Вт светодиод	1+0+F	[maggiorazione] € 135,00 supplement supplément Aufpreis дополнение	842	
• G)	Retroilluminati, sabbiatura cm 70 max, led 14 W Backlit mirrors, frame, frosted glass cm 70 max, led 14 W Miroirs avec la lumiere, cadre, en verre dépoli cm 70 max, led 14 W Spiegel mit integrierter LED-Leuchte, Rahmen verchromt, Milchglas cm 70 max, led 14 W Подсветка Chrome Frame, взрывные макс 70 см, Ш 14 LED	1+0+G	[maggiorazione] € 170,00 supplement supplément Aufpreis дополнение	842	
• H)	Retroilluminati, sabbiatura cm 100 max, led 19,9 W Backlit mirrors, frame, frosted glass cm 100 max, led 19,9 W Miroirs avec la lumiere, cadre, en verre dépoli cm 100 max, led 19,9 W Spiegel mit integrierter LED-Leuchte, Rahmen verchromt Milchglas cm 100 max, led 19,9 W Подсветка Chrome Frame, взрывные макс 100 см, Ш 19,9 LED	1+0+H	[maggiorazione] € 200,00 supplement supplément Aufpreis дополнение	842	
• i)	Retroilluminati, sabbiatura superiore a cm 100, led 19,9 W Backlit mirrors, frame, frosted glass cm 100 max, led 19,9 W Miroirs avec la lumiere, cadre, en verre dépoli cm 100 max, led 19,9 W Spiegel mit integrierter LED-Leuchte, Rahmen verchromt Milchglas cm 100 max, led 19,9 W Подсветка Chrome Frame, взрывные более 100 см, ширина 19,9 LED	1+0+i	[maggiorazione] € 290,00 supplement supplément Aufpreis дополнение	842	
• J)	Retroilluminati, doppia sabbiatura verticale cm 50 max, led 19,9 W Backlight mirrors, frame, double vertical frosted glass cm 50 max, led 19,9 W Miroirs avec la lumiere, cadre, en verre dépoli vertical cm 50 max, led 19,9 W Spiegel mit Hinterleuchtung, Halterung, Milchglas cm 50 max, led 19,9 W Зеркало со встроенной LED подсветкой 19,9 Вт, с хромированной окантовкой	1+0+J	[maggiorazione] € 240,00 supplement supplément Aufpreis дополнение	1115	
• K)	Retroilluminati cornice cromata, spot led, 3,5 W c.d., Ø 35 mm Backlight mirrors, frame, 3 spot led, 3,5 W c.d., Ø 35 mm Miroirs avec la lumiere, cadre, 3 spot led, 3,5 W, 3,5 W c.d., Ø 35 mm Spiegel mit Hinterleuchtung, Halterung 3 spot led, 3,5 W, 3,5 W c.d., led 19,9 W, Ø 35 mm Зеркало с подсветкой сзади, 3 LED режима, с хромированной окантовкой, Ø 35 mm	1+0+K	[maggiorazione] € 40,00 c.d. supplement supplément Aufpreis дополнение	1116	
• L)	Retroilluminati, punti POWER LED 3 W c.d., Ø 10 mm Backlit mirrors, frame, 6 POINT POWER LED, led 3 W c.d., Ø 10 mm Miroirs avec la lumiere, cadre, poli cm 6 POINTS POWER LED 3 W c.d., Ø 10 mm Spiegel mit Hinterleuchtung, Halterung, 6 Punkte Power LED, led 3 W c.d., Ø 10 mm подсветкой, хромированная рама, 6 точек POWER LED 3 W c.d., Ø 10 mm	1+0+L	[maggiorazione] € 35,00 c.d. supplement supplément Aufpreis дополнение	1285	
• M)	LED perimetrale, con canalina protetta montata a filo specchio (per mt) LED perimeter with frame protected, mounted mirror wire (for mt) Périmètre LED avec cadre de protection, fil de miroir monté (pour mt) LED seitlich, mit integrierter satiniertes abdeckung, amrand LED по периметру, с изоляционной защитой, установленной заподлицо зеркала	1+0+M	[maggiorazione] € 45,00 supplement supplément Aufpreis дополнение	948	

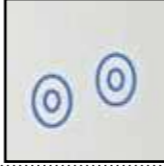
• N)	LED perimetrale, con canalina protetta montata 3 cm interno specchio (per mt) LED perimeter with frame protected mounted 3 cm interior mirror (for mt) Périmètre LED avec cadre de protection monté de 3 cm de intérieur de miroir (pour mt) LED seitlich, mit integrierter satiniertes abdeckung, amrand 3 cm rahmen-rudsprung (pro mt) LED по периметру, с изоляционной защитой, установленной 4 см внутри зеркала (на метр)	1+0+N	[maggiorazione] € 45,00 supplement supplément Aufpreis дополнение	1159	
• DA)	Luce perimetrale con sabbiatura esterna 4 cm e cornice(per mt) Perimeter light with external sandblasting 4 cm and frame (for mt) Lumière périphérique avec sablage externe de 4 cm et cadre (pour mt) Umgebungslicht mit externer Sandstrahlung von 4 cm und Rahmen (pro mt) Периметральный свет с наружной пескоструйной обработкой 4 см и рамкой (за метр)	1+0+DA	[maggiorazione] € 75,00 supplement supplément Aufpreis дополнение	1139	
• X)	Luce perimetrale con sabbiatura esterna 4 cm (per mt) Perimeter light with external sanding 4 cm (for mt) Lumière périmétrique avec ponçage extérieur 4 cm (pour mt) Begrenzungsleuchte mit Außenschliff 4 cm (pro mt) Периметровое освещение с внешней пескоструйной обработкой 4 см (на метр)	1+0+X	[maggiorazione] € 70,00 supplement supplément Aufpreis дополнение	1192	
• X2)	Luce perimetrale con sabbiatura esterna 3 cm per tondo (per mt) Perimeter light with external sandblasting 3 cm for round shape (for mt) Lumière périphérique avec sablage externe de 3 cm pour forme ronde (pour mt) Umgebungslicht mit externer Sandstrahlung von 3 cm für runde Form (pro mt) Периметральный свет с наружной пескоструйной обработкой 3 см для круглой формы (на метр)	1+0+X2	[maggiorazione] € 70,00 supplement supplément Aufpreis дополнение		
• Y)	Luce perimetrale con sabbiatura 3cm, interno specchio 7 cm (per mt) Perimeter light with 3cm sanding, inside mirror 7 cm (per mt) Lumière périmétrique avec ponçage de 3 cm, miroir intérieur de 7 cm (par mt) Begrenzungsleuchte mit 3-cm-Schliff, Innenspiegel 7 cm (pro mt) Светильник по периметру с 3 см шлифовкой, внутреннее зеркало 7 см (на метр).	1+0+Y	[maggiorazione] € 95,00 supplement supplément Aufpreis дополнение	1193	
• CCO)	Sabbiatura costa a costa (non prevede N/M) Coast to coast sandblasting (no N/M) Sablage de côte à côte (pas de N/M) Sandstrahlen von Küste zu Küste (kein N/M) Пескоструйная очистка от берега до берега (нет N/M)	1+0+F+CCO	[maggiorazione] € 50,00 supplement supplément Aufpreis дополнение	1175	
• FA)	Retroilluminati, sabbiatura Ø cm 50 x 2, led 19,9 W Backlit, sandblasted Ø cm 50 x 2, LED 19,9 W Rétroéclairé, sablage Ø cm 50 x 2, LED 19,9 W Rückseitig beleuchtet, sandgestrahlt Ø cm 50 x 2, LED 19,9 W Подсвечиваемый, пескоструйный Ø см 50 x 2, LED 19,9 Вт	1+0+FA	[maggiorazione] € 200,00 supplement supplément Aufpreis дополнение	1339	
• FB)	Retroilluminati, sabbiatura cm 50 x 50 x 2, led 19,9 W Backlit, sandblasted cm 50 x 50 x 2, LED 19,9 W Rétroéclairé, sablé cm 50 x 50 x 2, LED 19,9 W Rückseitig beleuchtet, sandgestrahlt cm 50 x 50 x 2, LED 19,9 W Подсвечиваемый, пескоструйный см 50 x 50 x 2, LED 19,9 Вт	1+0+FB	[maggiorazione] € 200,00 supplement supplément Aufpreis дополнение	1340	

OPZIONI / OPTION / OPTIONS / OPTIONEN / ВАРИАНТЫ

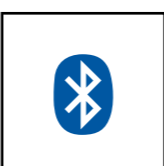
• P)	<p>Interruttore a sfioramento per specchi (distanza superiore a 15 cm da parete) Touchless switch for mirrors (distance greater than 15 cm from wall) Interrupteur tactile pour miroirs (distance supérieure à 15 cm du mur) Touch-Schalter für Spiegel (Abstand größer als 15 cm von der Wand) Сенсорный выключатель для зеркала (на расстоянии более 15 см от стены)</p>	[maggiorazione] € 45,00 supplement supplément Aufpreis дополнение	
• V)	<p>Interruttore touch su specchio Touch switch on mirror Interrupteur tactile sur le miroir Berührungsschalter am Spiegel Сенсорный выключатель на зеркале</p>	[maggiorazione] € 45,00 supplement supplément Aufpreis дополнение	
• V2)	<p>Doppio interruttore (1 dimerabile + 1 On/Off) Double switch (1 dimmable + 1 On/Off) Double interrupteur (1 gradable + 1 On/Off) Doppelter Schalter (1 dimmbar + 1 ein/aus) Двойной выключатель (1 диммируемый + 1 вкл/выкл)</p>	[maggiorazione] € 80,00 supplement supplément Aufpreis дополнение	
• Q)	<p>Resistenza antiappannamento per specchi (superiori a 120cm si applicano 2 resistenze) - specificare modalità di accensione Anti-fog resistance for mirrors (more than 120cm, we add 2 heating elements) - specify ignition mode Résistance anti-buée pour les miroirs (plus de 120cm, 2 éléments chauffants sont recommandés) - spécif spécif spécif mode d'allumage Anti-Beschlag für Spiegel (mehr als 120cm, 2 Heizelemente werden empfohlen) - Zündungsmodus angeben функция антизапотевания (более 120 см, рекомендуется использовать 2 нагревательных элемента) - укажите режим зажигания</p>	[maggiorazione] € 45,00 supplement supplément Aufpreis дополнение	
• R)	<p>Specchio ingranditore 3X integrato sul vetro per specchi ø 21 Integrated 3X magnifying mirror on the glass for mirrors ø 21 Miroir grossissant intégré 3X sur le verre pour miroirs ø 21 Integrierter 3-fach Vergrößerungsspiegel auf dem Glas für Spiegel ø 21 Интегрированное зеркало с увеличением 3X на стекле для зеркал ø 21</p>	[maggiorazione] € 200,00 supplement supplément Aufpreis дополнение	
• S)	<p>Specchio ingranditore 3X RETROILLUMINATO integrato sul vetro per specchi ø 21 Backlit integrated 3X magnifying mirror on the glass for mirrors ø 21 Miroir grossissant intégré rétroéclairé 3X sur le verre pour miroirs ø 21 Rückseitig beleuchteter integrierter 3-fach Vergrößerungsspiegel auf dem Glas für Spiegel ø 21 Подсвечиваемое интегрированное зеркало с увеличением 3X на стекле для зеркал ø 21</p>	[maggiorazione] € 400,00 supplement supplément Aufpreis дополнение	
• U)	<p>Impianto bluetooth senza comandi con specchio retroilluminato Bluetooth plants without controls with back light mirror Bluetooth système sans commandes avec des miroirs rétro-éclairés Bluetooth-Anlage ohne Bedienungseinheit система bluetooth без команд с зеркалом с подсветкой</p>	[maggiorazione] € 90,00 supplement supplément Aufpreis дополнение	
	<p>Impianto bluetooth senza comandi per specchio senza illuminazione (fornito con alimentatore) Bluetooth plants without controls with mirror without illumination (supplied with power supply) Bluetooth système sans commandes avec miroir d'éclairage (fourni avec l'alimentation) Bluetooth-Anlage ohne Bedienungseinheit für Spiegel ohne Beleuchtung система bluetooth без команд для зеркал без подсветки (поставляется вместе с блоком питания)</p>	[maggiorazione] € 120,00 supplement supplément Aufpreis дополнение	



LED 4000 K

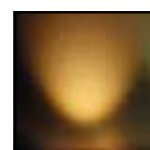

LED 2700 K

SU RICHIESTA
 on demand
 Sur demande
 Auf Anfrage
 По запросу

IMBALLI - Per spedizioni si provvederà al recupero in fattura di:

€ 5,00 netti a specchio per misure fino cm150
 € 10,00 netti a specchio per misure superiori cm 150

PACKAGING - For shipments of mirrors we will debit:

€ 5,00 as extra packing contribution for mirror under cm 150.
 € 10,00 as extra packing contribution for mirror over cm 150.

EMBALLAGE - Dans les livraisons des miroirs nous allons debiter en facture:

€ 5,00 net sous titre de fret d'emballage special dessous cm 150.
 € 10,00 net sous titre de fret d'emballage special dessus cm 150.

AUFSCHLAG FÜR SPIEGEL - Sonderverpackungen:

€ 5 netto Sonderverpackungen unter 150 cm
 € 10 netto Sonderverpackungen über 150 cm

Упаковка - для перевозок мы добавляем в счет:

5 евро нетто для зеркал размером до 150 см
 10 евро нетто для зеркал размером более 150 см

OPZIONI TAGLIO VETRO / Glass cutting options / Options de découpe du verre / Glas-Schneidoptionen / Варианты резки стекла

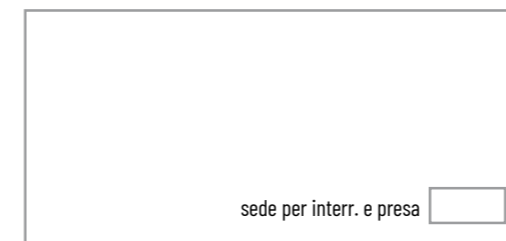

1. Specchio con sede per interruttore a parete
 Mirror with seat for wall switch
 Miroir avec siège pour interrupteur mural
 Spiegel mit Sitz für Wandschalter
 Зеркало с сиденьем для настенного выключателя
 € 90,00 Maggiorazione
 supplement / supplément / Aufpreis / дополнение

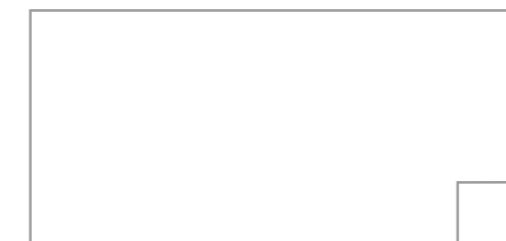

2. Specchio con scasso per interruttore a parete
 Mirror with burglary for wall switch
 Miroir avec cambriolage pour interrupteur mural
 Spiegel mit Einbruchschutz für Wandschalter
 Зеркало со взломом для настенного выключателя
 € 70,00 Maggiorazione
 supplement / supplément / Aufpreis / дополнение

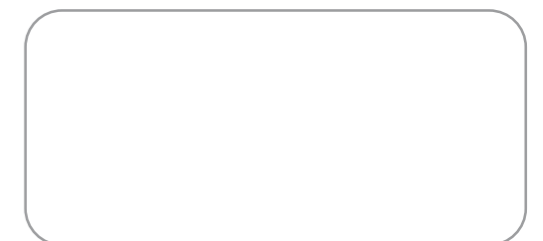

3. Specchio con angolo arrotondato R5
 Mirror with rounded corner R5
 Miroir avec coin arrondi R5
 Spiegel mit abgerundeter Ecke R5
 Зеркало с закругленным углом R5
 € 50,00 Maggiorazione
 supplement / supplément / Aufpreis / дополнение



3. Specchio con Taglio inclinato
 Mirror with inclined cut / Miroir à coupe inclinée
 Spiegel mit schrägem Schnitt / Зеркало с наклонным разрезом
 € 50,00 Maggiorazione
 supplement / supplément / Aufpreis / дополнение

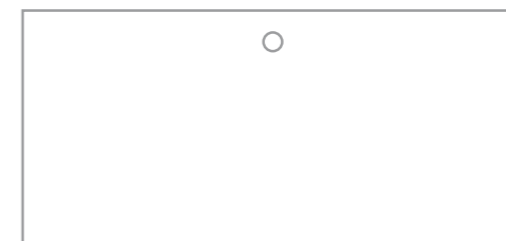

4. Foro su specchio Ø 12
 Hole on mirror Ø 12 / Trou sur le miroir Ø 12
 Bohrung am Spiegel Ø 12 / Отверстие на зеркале Ø 12
 € 30,00 Maggiorazione
 supplement / supplément / Aufpreis / дополнение

FISSAGGI LAMPADE/ Lamp fixings / Fixations de lampe / Lampenbefestigungen / Крепления для ламп

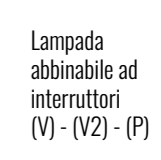

Lampada
 abbinabile ad
 interruttori
 (V) - (V2) - (P)



Entra nel configuratore Scegli la proposta
Clicca su specchi e segui le richieste:

- Tipo Vetro
- Dimensioni
- Luce Interna
- Cornice
- Tipo Luce Interna
- Sabbiatura Costo to Cost
- Posizione Sabbiatura
- Opzioni
- Colore Led
- Lampade
- Luci per Specchi

Enter the configurator choose the proposal
click on mirrors and follow the requests:

- glass type
- dimensions
- interior light
- frame
- internal light type
- sandblasting cost to cost
- sandblasting position
- options
- led color
- lamps
- mirror lights

Entrez dans le configurateur Choisissez votre proposition
Cliquez sur les miroirs et suivez les instructions :

- Type de verre
- Dimensions
- Lumière interne
- Cadre
- Type de lumière interne
- Sablage Coût à Coût
- Position Sandblasting
- Options
- Couleur Led
- Lampes
- Miroir lumineux

Zugang zum Konfigurator Wählen Sie Ihren Vorschlag
Klicken Sie auf Spiegel und folgen Sie den Anweisungen:

- Glas Typ
- Abmessungen
- Internes Licht
- Rahmen
- Interner Lichttyp
- Sandstrahlen Kosten zu Kosten
- Position Sandstrahlen
- Optionen
- Led Farbe
- Lampen
- Spiegel Lichter

Войдите в конфигуратор Выберите свое предложение
Нажмите на зеркала и следуйте требованиям:

- Тип стекла
- Размеры
- Внутренний свет
- Рама
- Тип внутреннего освещения
- Пескоструйная обработка Стоимость к стоимости
- Положение Пескоструйная обработка
- Опции
- Цвет светодиодов
- Лампы
- Зеркальные лампы

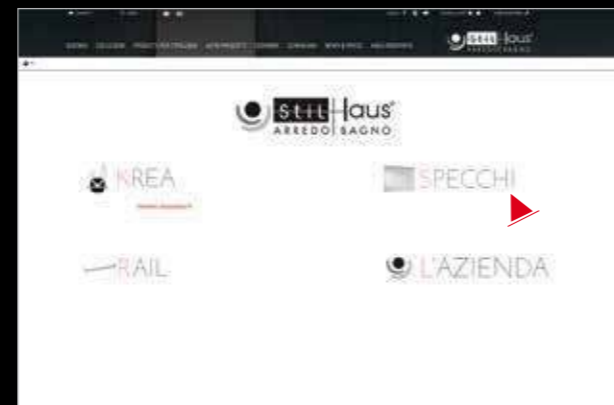

Al termine della configurazione, cliccando sul carrello potrete visionare le opzioni richieste ed il prezzo di listino.

At the end of the configuration, by clicking on the cart you can check the required options and the list price.

À la fin du processus de configuration, cliquez sur le panier pour afficher les options requises et le prix catalogue.

Klicken Sie am Ende des Konfigurationsprozesses auf den Warenkorb, um die gewünschten Optionen und den Listenpreis anzuzeigen.

В конце процесса настройки нажмите на корзину, чтобы просмотреть необходимые опции и прейскурантную цену.



Indica:

- Privato: richiesta punto vendita in azienda
- Preventivo: invio mail preventivo
- Ordine rivenditore: inserimento ordini

Indicate:

- private: you can ask your nearest stilhaus shop
- quotation: ask a quotation directly to our company
- Retailer order: placing orders as direct already registered customer

Indique :

- Privé : demande de point de vente en entreprise
- Devis : envoyer un devis par courriel
- Commande du détaillant : passation de commande

Zeigt an:

- Privat: Anfrage zur Verkaufsstelle im Unternehmen
- Angebot: Angebot per E-Mail senden
- Bestellung des Einzelhändlers: Auftragserteilung

Указывает:

- Частное лицо: запрос торговой точки в компании
- Предложение: отправить предложение по электронной почте
- Заказ розничного продавца: размещение заказа

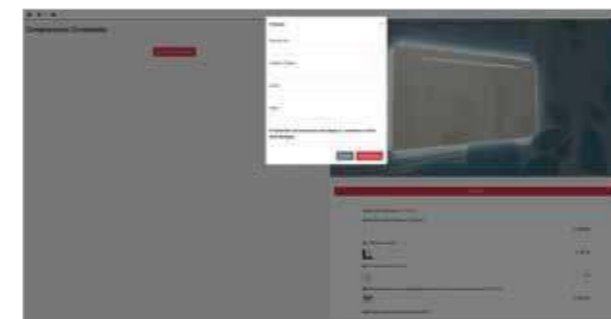

Pour commander, veuillez remplir les champs :

- Numéro de TVA.
- Numéro de client (exemple : 000111) que vous pouvez trouver dans nos confirmations de commande précédentes, pour les nouveaux clients, veuillez demander dans l'entreprise.
- Votre adresse électronique.
- Des notes.
- La commande sera saisie directement dans notre système de gestion pour votre confirmation ultérieure.

Per ordine, compilare i campi:

- Partita Iva.
- Numero cliente(esempio: 000111) che potete trovare nelle nostre conferme ordine precedenti, per i nuovi clienti, chiedere in azienda.
- Vostro indirizzo e-mail.
- Eventuali note.
- L'ordine verrà inserito direttamente nel nostro gestionale per Vs successiva conferma.

Fill in the fields to order:

- vat number
- customer number (example: 000111) that you can find in our previous order confirmations, for new customers, ask the company
- your e-mail address
- possible notes
- the order will be placed directly in our management system for your subsequent confirmation.

Um zu bestellen, füllen Sie bitte die Felder aus:

- Umsatzsteuer-Identifikationsnummer.
- Kundennummer (Beispiel: 000111), die Sie in unseren bisherigen Auftragsbestätigungen finden, bei Neukunden bitte in der Firma erfragen.
- Ihre E-Mail Adresse.
- Irgendwelche Notizen.
- Die Bestellung wird direkt in unser Verwaltungssystem eingegeben und von Ihnen bestätigt.

Для заказа, пожалуйста, заполните поля:

- Номер НДС.
- Номер клиента (пример: 000111), который вы можете найти в наших предыдущих подтверждениях заказов, для новых клиентов, пожалуйста, спросите в компании.
- Ваш адрес электронной почты.
- Любые замечания.
- Заказ будет введен непосредственно в нашу систему управления для последующего подтверждения.



ILLUMINAZIONE

Designer: STILHAUS, PALUDI

Fuori misura: Sì
I prezzi delle illuminazioni a bassa tensione (12V)
comprendono il costo dei trasformatori.
RAEE: Iscr. Al Registro A.E.E. n. IT 3110000008191,
i prezzi delle illuminazioni non comprendono il contributo

Customized: Yes
The prices of the low-voltage halogen lights (12V)
include the cost of the transformers.
RAEE: Iscr. Register to A.E.E. n. 3110000008191 IT,
prices do not include the contribution of the illuminations

Personnalisé: Oui
Les prix des lampes halogènes basse tension (12V)
comprennent le coût des transformateurs.
RAEE: Iscr. Inscrivez-vous pour A.E.E. n. 3110000008191 IT,
prix ne comprennent pas la contribution des illuminations

Kundenwunsch: Ja
Die Preise für die Niedervolt-Halogenlampen (12V)
sind die Kosten der Transformatoren.
RAEE: Iscr. Registrieren A.E.E. n. 3110000008191 IT,
Preise ohne Leuchtmittel

Негабаритный: да
Цены на низковольтных галогенных ламп (12V)
включают в себя стоимость трансформаторов.
RAEE: ISCR. Зарегистрируйся, чтобы A.E.E. n. 3110000008191 IT,
Цены не включают вклад иллюминации

692

Plafoniera vetro sabbato
 Ceiling lamp
 Plafonnier
 Deckenleuchte
 Люстра в латунном обрамлении
 cm Ø 34 x 14 H

CE: V 220 IP20 40Wx2

• 08	€ 189,00
• 02	€ 197,00
• 16 - 25 - 26 - 36	€ 240,00



16



25



36

991 NE

Lampadario con paralume tessuto nero
 Brass chandelier with black fabric lampshade
 Lustre en laiton avec abat-jour tissu noir
 Hängeleuchte mit Lampenschirm aus schwarzem Stoff
 Латунная люстра с тремя лампами и абажуром (модель)
 cm Ø 32 x 74 H

CE: V 220 IP20 60Wx1

• 08	€ 220,00
• 16 - 25	€ 280,00



991 BI

Lampadario con paralume tessuto bianco
 Brass chandelier with white fabric lampshade
 Lustre en laiton avec abat-jour tissu blanc
 Hängeleuchte mit Lampenschirm aus weißem Stoff
 Латунная люстра с тремя лампами и абажуром (модель)
 cm Ø 32 x 74 H

CE: V 220 IP20 60Wx1

• 08	€ 220,00
• 16 - 25	€ 280,00



ILLUMINAZIONE

1334 sp

HASHI applique LED per specchio

LED mirror sconce by HASHI

Applique LED pour miroir de HASHI

LED-Spiegelleuchte von HASHI

Накладная светодиодная

лампа для зеркала от HASHI

cm 40 L x 5 P x 5 H

CE: V 220 IP21 LED 8W 4000K



• 08 - 23 - 24	€ 179,00
• 36 - 18 - 56	€ 230,00
• FN	€ 270,00



18

57

08

ILLUMINAZIONE

1342 sp ONE

Applique per specchio a LED

Applique for mirrorLED

Applique pour miroir LED

Leuchte für Spiegel LED

Верхний светильник

для зеркала LED

cm 6,5 L x 13 P x 10 H

CE: V 220 IP23 LED 3,5W 4000K

• 08 - 23 - 24	€ 190,00
• 36 - 18	€ 240,00
• FN	€ 280,00



ONE

designer Paludi Gianluca

36



08



1134 SP

Applique per specchio a led
 Led mirror lamp
 Lampe a Led pour miroir
 LED Leuchte für Spiegel
 Светодиодный настенный
 светильник для зеркала
 cm 30 L x 11 P x 4,5 H



CE: V 220 IP 44 4,8W 4000K

- 08 € 89,00
- 23 € 96,00
- 3000K maggiorazione / supplement
supplément / Zuschlag
дополнительно € 10,00



1135 SP

Applique per specchio a led
 Led mirror lamp
 Lampe a Led pour miroir
 LED Leuchte für Spiegel
 Светодиодный настенный
 светильник для зеркала
 cm 45 L x 11 P x 5 H



CE: V 220 IP44 8W a 12 Vdc 4000K

- 08 € 119,00
- 3000K maggiorazione / supplement
supplément / Zuschlag
дополнительно € 10,00



1136 SP

Applique per specchio a led
 Led mirror lamp
 Lampe a Led pour miroir
 LED Leuchte für Spiegel
 Светодиодный настенный
 светильник для зеркала
 cm 56 L x 15 P x 4 H



CE: V 220 IP44 8W a 12 Vdc 4000K

€ 149,00



1104 SP LED

Applique per specchio a LED
 Applique for mirror LED
 Applique pour miroir LED
 Leuchte für Spiegel LED
 Верхний светильник
 для зеркала LED
 cm 34,5 L x 9 P x 4 H



CE: V 220 IP44 9W 4000K

- 08 € 155,00



1105 SP LED

Applique per specchio LED
 Applique for mirror LED
 Applique pour miroir LED
 Leuchte Spiegel LED
 Верхний светильник
 для зеркала LED
 cm 55,5 L x 9 P x 4 H



CE: V 220 IP44 15W 4000K

- 08 € 189,00



1277 SP LED

Applique per specchio a LED
 Led mirror lamp
 Lampe a Led pour miroir
 LED Leuchte für Spiegel
 Светодиодный настенный
 светильник для зеркала
 cm 32 L x 5 P x 2 H



CE: V 220 IP44 15W 4000K

- 08 € 95,00

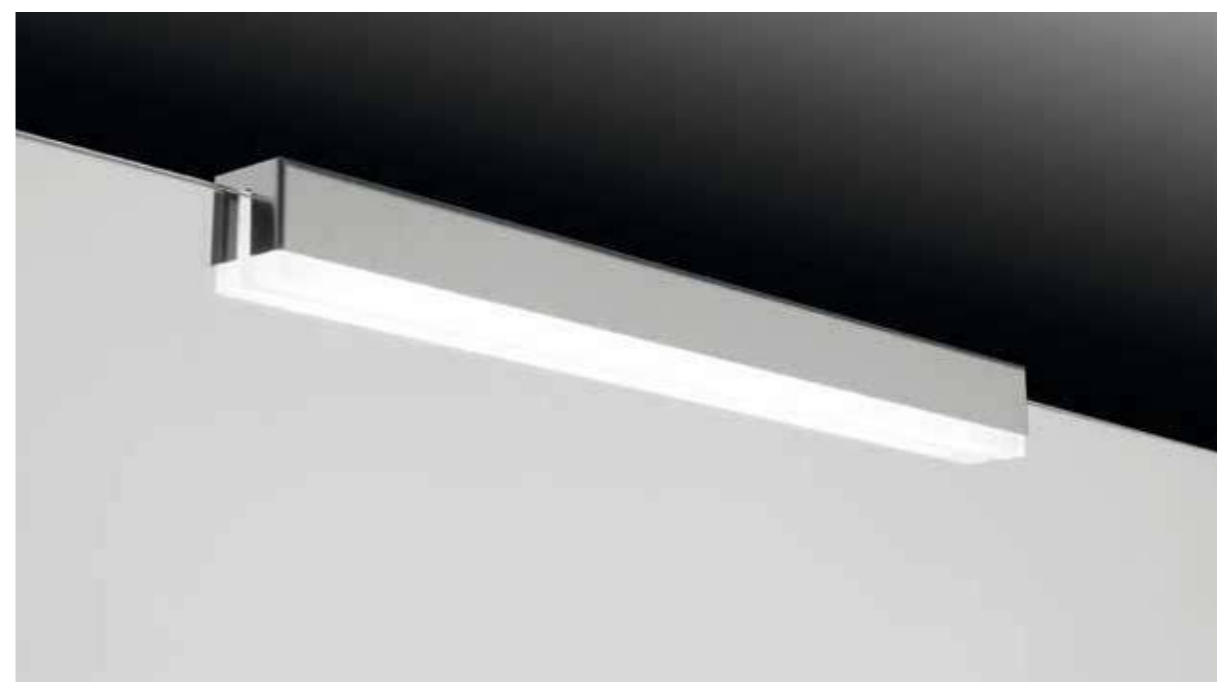

1245 SP LED

Applique LED per specchio
Led mirror lamp
Lampe a Led pour miroir
LED Leuchte für Spiegel
Светодиодный настенный
светильник для зеркала

cm 20 L x 4 P x 4 H
CE : V 220 IP44 LED 7W a 12 Vdc 4000K



€ 135,00



1110 SP

Applique per specchio a led
Led mirror lamp
Lampe a Led pour miroir
LED Leuchte für Spiegel
Светодиодный настенный
светильник для зеркала

cm 7,5 L X 10,5 P X 29 H
CE : V 220 IP 44 G9 3W 3000K



- 08 € 150,00
- 23 € 160,00



1060 CALAMITA

Applique per specchio a led calamitata
Led mirror lamp magnetized
Lampe a Led pour miroir magnétisée
LED Leuchte für Spiegel magnetisiert
Светодиодный настенный
светильник для зеркала

cm Ø 8 x 4 H
CE : V 220 5 W 4000K

- 08 - CAVO ROSSO - RED WIRE € 160,00
- 08 - CAVO NERO - BLACK WIRE € 160,00
- PIASTRA SPECCHIO / Mirror plate € 14,00



774 SP

Applique LED per specchio
Led mirror lamp
Lampe a Led pour miroir
LED Leuchte für Spiegel
Светодиодный настенный
светильник для зеркала

cm 7,5 L x 10,5 P x 7,5 H
CE : V 230 - IP44 4W



- 08 - 23 - 24 € 100,00
- 36 - 18 € 125,00
- FN € 140,00



1198

Lampada per specchio forato Ø 10
Led mirror lamp
Lampe a Led pour miroir
LED Leuchte für Spiegel
Светодиодный настенный
светильник для зеркала

cm 10,5 L X 10,5 P X 10 H
CE : V 220 IP 44 G9 3W 3000K

- 08 € 65,00

Foro su specchio / Hole on mirror /
Trou dans le miroir / Loch im Spiegel /
Отверстие на зеркале € 30,00

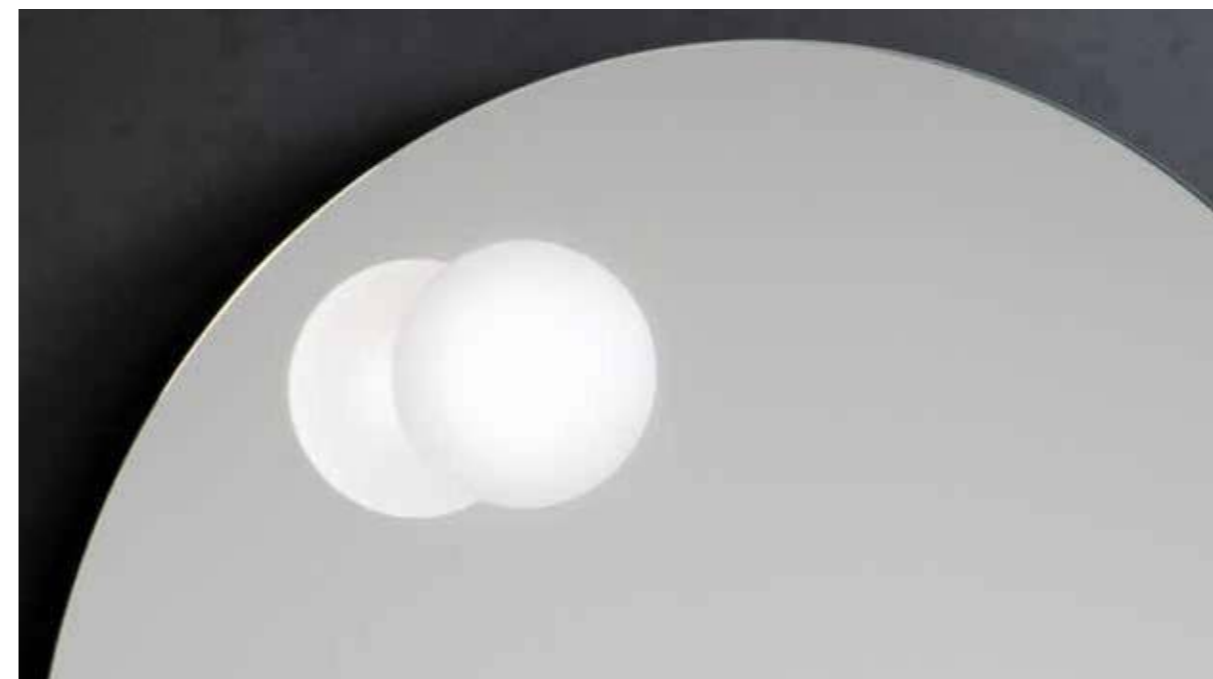

1345 sp

Applique per specchio LED
Applique for mirror LED
Applique pour miroir LED
Leuchte für Spiegel LED
Верхний светильник
для зеркала LED

cm 3 H
CE : V 230 IP44 6W 4000K



- 1345/70SP Ø 70 • 08 - 23 € 120,00
- 1345/80SP Ø 80 • 08 - 23 € 130,00
- 1345/90SP Ø 90 • 08 - 23 € 140,00



1344 sp

Applique per specchio ABS
 ABS mirror sconce
 Applique de miroir en ABS
 Spiegelleuchte aus ABS
 Накладная лампа для зеркала из ABS

cm 5 L x 6 P x 4 H

CE: V 230 IP44 G9 2W



• 08 - 23 - 24

€ 29,00



1103 SP LED

Applique LED per specchio
 Led mirror lamp
 Lampe a Led pour miroir
 LED Leuchte für Spiegel

Светодиодный настенный
 светильник для зеркала

cm 11 L x 7,5 P x 7 H

CE: V 220 IP 20 4,8W 4000K



• 08

€ 60,00

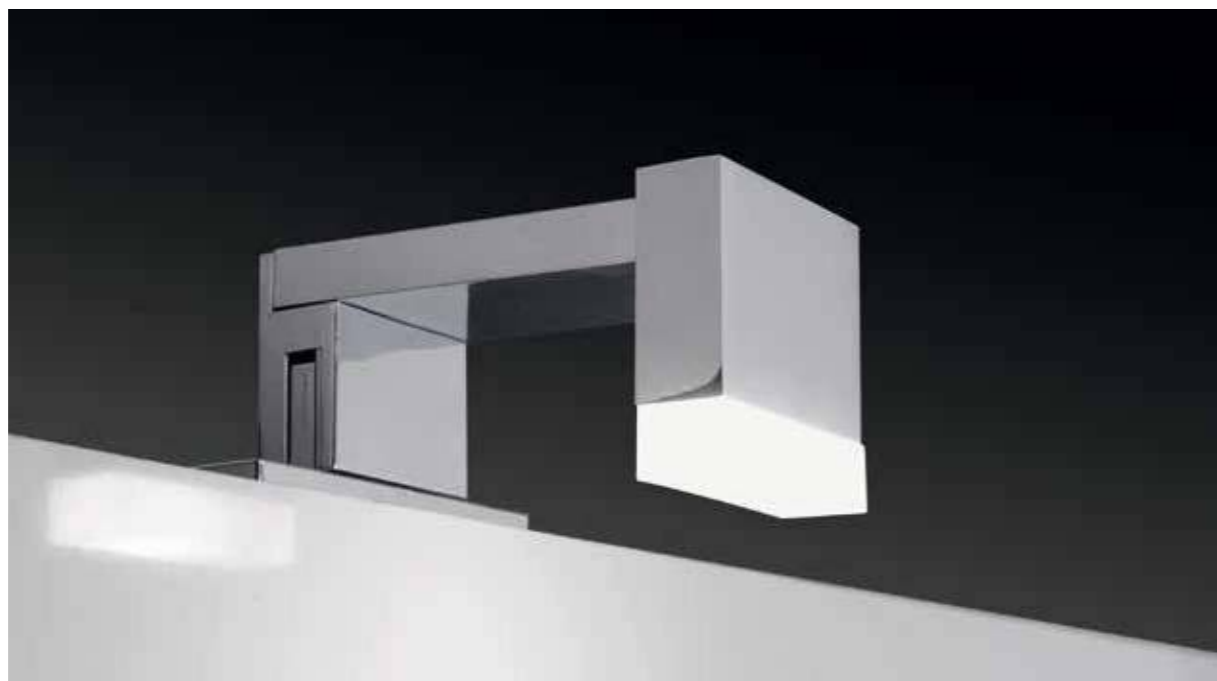

1108 SP LED

Applique LED per specchio
 Led mirror lamp
 Lampe a Led pour miroir
 LED Leuchte für Spiegel

Светодиодный настенный
 светильник для зеркала

cm 20 L x 12 P x 4 H

CE: V 220 IP23 LED 6W a 12 Vdc 4000K



€ 98,00



1322 SP

Lampada LED per specchio
 LED lamp for mirror
 Lampe LED pour miroir
 LED-Lampe für Spiegel

Светодиодная лампа для зеркала

cm 30 L x 11 P x 3 H

CE: V 220 IP44 G9 3W x 2 3000K



•

€ 50,00

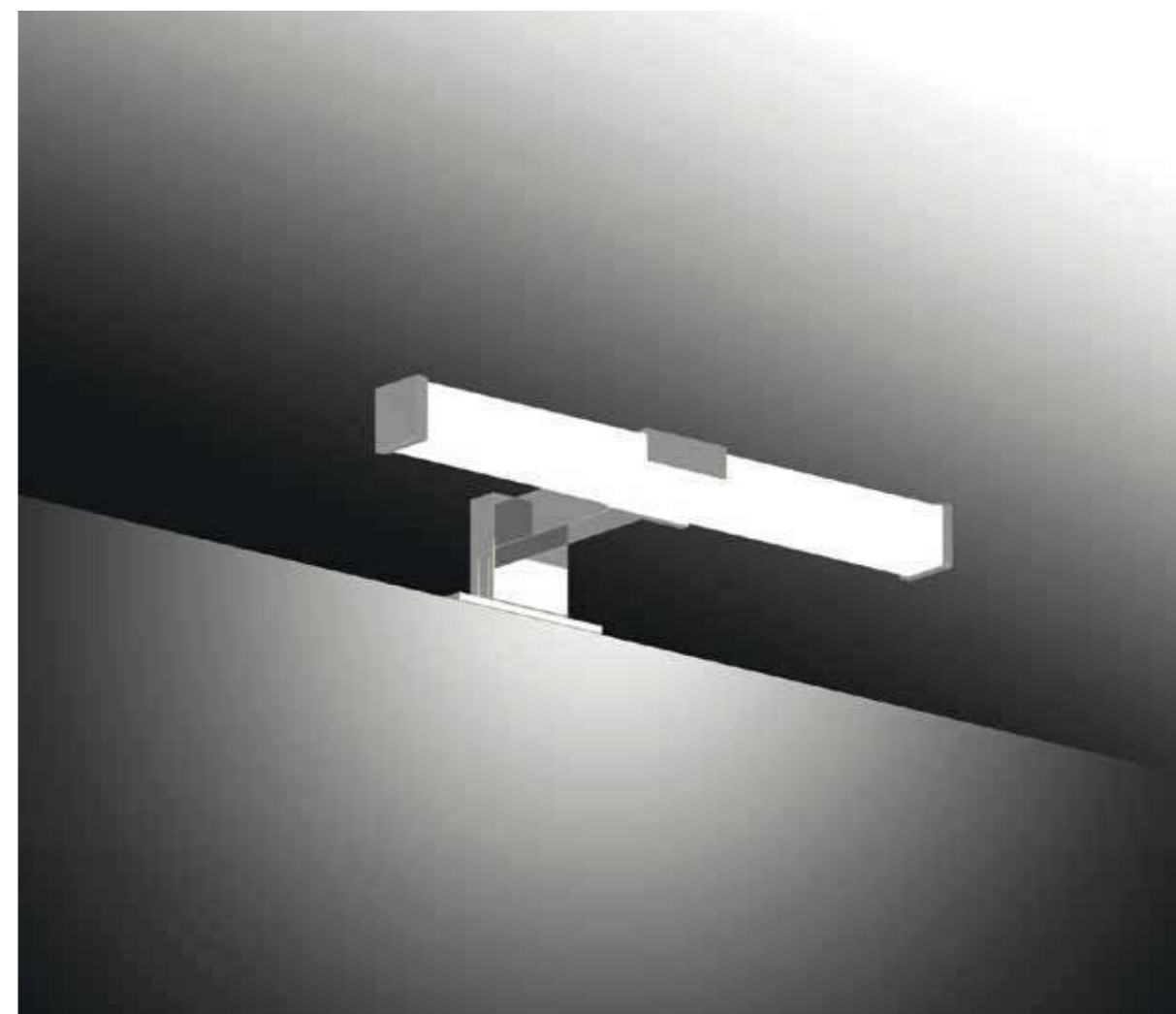

1325 SP

Lampada LED per specchio
 Applique with fixing for mirror adjustable
 Applique pour miroir réglable
 Leuchte für Spiegel verstellbar

Верхний светильник для зеркала

cm 50 L x 11 P x 3 H

CE: V 220 IP44 G9 3W x 2 3000K

•

€ 90,00

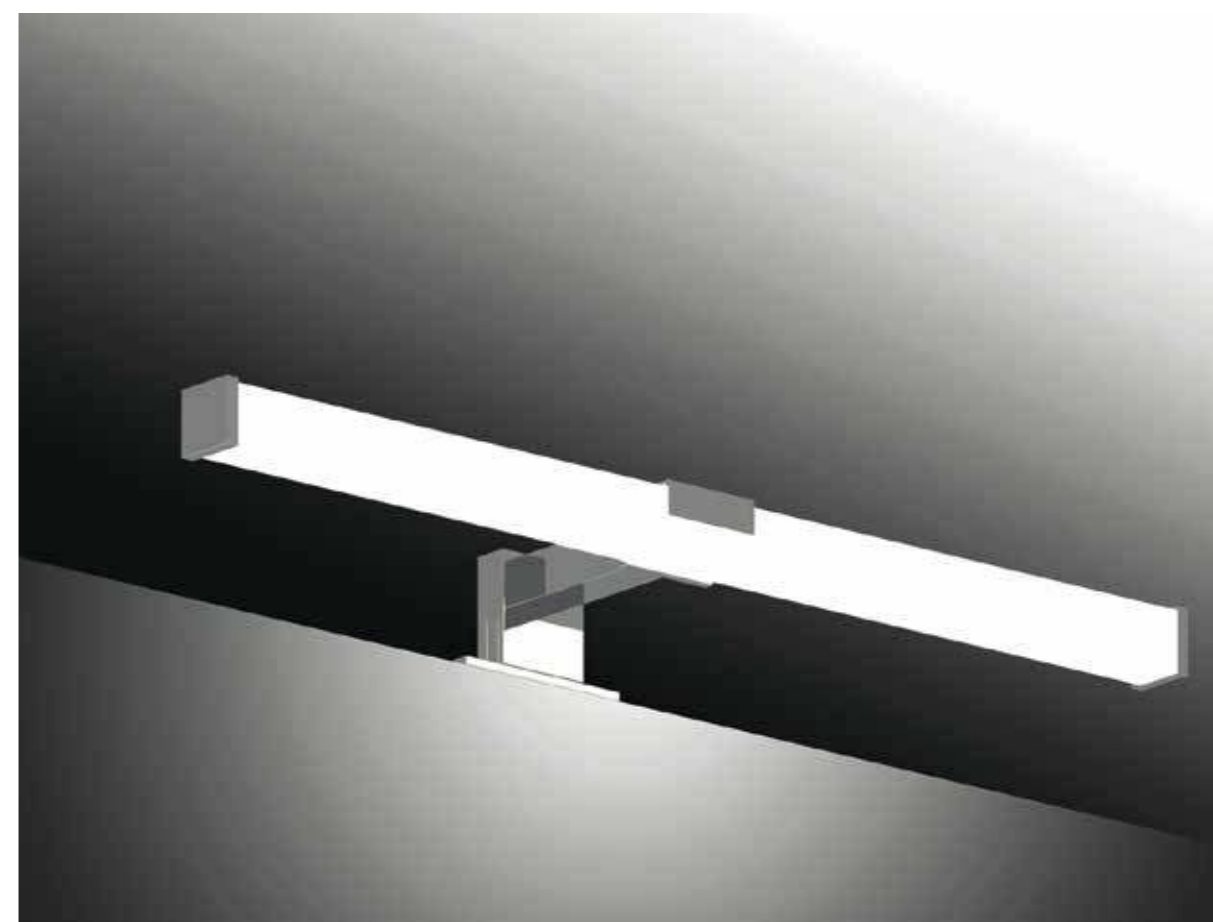

1228 SP LED

Applique per specchio LED
Applique for mirror LED
Applique pour miroir LED
Leuchte für Spiegel LED
Верхний светильник для зеркала LED



cm 57 L x 3 P x 3 H

CE: V 220 IP44 4000K

• 1228 sp /50 - cm 50 L - W 7	€ 144,00
• 1228 sp /70 - cm 70 L - W 10	€ 159,00
• 1228 sp /90 - cm 90 L - W 12,5	€ 169,00

* SU MISURA - 14W x mt (max 190cm)

• 1228 SP /FM*	€ 100,00 + € 15,00 x 10 cm
----------------	----------------------------

ESEMPIO

1228 SP/FM
cm 120 L - € 100,00 + € 15,00 x 12 = € 280,00

1228 SP/FM
cm 175 L - € 100,00 + € 15,00 x 17,5 = € 362,50

* DISPONIBILE IN 20 GG.
Available in 20 days
Disponible en 20 jours
Verfügbar in 20 Tagen
Доступно через 20 дней



B 03 SP

Applique per specchio paralume M
Applique for mirror, lampshade M
Applique pour miroir, abat-jour M
Leuchte für Spiegel, Lampenglass M
Настенный светильник с абажуром регулируемый



cm 5 L x 10 P x 20 H

CE: V 220 IP44 40Wx1

• 08	€ 69,00
------	---------



502

Applique per specchio con trasformatore
Applique with fixing for mirror and transformer
Applique pour miroir avec transformateur
Leuchte für Spiegel mit Transformator
Верхний бра с трансформатором



cm 6 L x 2,5 P

CE: V 220/12V - IP20 - 20Wx2

• 08	€ 149,00
------	----------



> PAG. 305



502

1064 SP LED

Applique per specchio orientabile
Applique with fixing for mirror adjustable
Applique pour miroir réglable
Leuchte für Spiegel verstellbar
Верхний светильник для зеркала

cm 37 L x 11 P x 3 H

CE: V 220 IP44 G9 3W x 2 3000K

• 08	€ 195,00
• 16 - 25 - 26	€ 260,00



ILLUMINAZIONE a parete

1342 ONE

Applique LED a parete
Wall mounted LED applique
Applique à mur à LED
LED Wandleuchte
Настенные светильники светодиодный
cm 8 L x 12 P x 12 H

CE : V220 IP23 LED 3,5W 4000K
• 08 - 23 - 24 € 195,00
• 36 - 18 € 260,00
• FN € 290,00

ONE

designer Paludi Gianluca

08



FN



ILLUMINAZIONE a parete

1134

Applique LED a parete
Wall mounted LED applique
Applique à mur à LED
LED Wandleuchte
Настенные светильники светодиодный
cm 30 L x 10 P x 8 H

CE : V220 IP44 LED 4,8W/12V 4000K
• 08 € 125,00
• 23 € 135,00
• 3000K maggiorazione / supplément / supplément / Zuschlag / дополнительно € 10,00



1134

1135

Applique LED a parete
Wall mounted LED applique
Applique à mur à LED
LED Wandleuchte
Настенные светильники светодиодный
cm 45 L x 15 P x 8 H

CE : V220 IP44 LED 7,9 W/12V 4000K
• 08 € 145,00



1135

1104

Applique LED a parete
Wall mounted LED applique
Applique à mur à LED
LED Wandleuchte
Настенные светильники светодиодный
cm 34,5 L x 9 P x 8 H

CE : V220 IP20 LED 9,6W/12V 4000K
• 08 € 179,00



1104

1105

Applique LED a parete
Wall mounted LED applique
Applique à mur à LED
LED Wandleuchte
Настенные светильники светодиодный
cm 55 L x 9 P x 8 H

CE : V220 IP20 LED 12,5W/12V 4000K
• 08 € 220,00

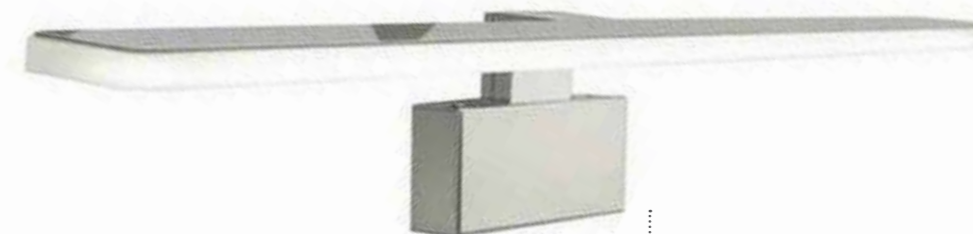

1105

ILLUMINAZIONE a parete

1061

Applique LED a parete
Wall mounted LED applique
Applique à mur à LED
LED Wandleuchte
Настенные светильники светодиодный

cm 55 L x 4 P x 5,5 H

CE: V220 IP23 LED 9,6W/12V 4000K

• 54 € 145,00



1064 LED

Applique orientabile a LED
Adjustable applique LED
Applique réglable LED
Wandleuchte verstellbar LED
Регулируемый настенный светильник с абажуром LED

cm 37 L x 22 P x 17 H

CE: V 220 IP44 G9 3W x 2 3000K

• 08 € 198,00

• 16 - 25 - 26 € 260,00



ILLUMINAZIONE a parete

1110

Applique LED a parete
Wall mounted LED applique
Applique à mur à LED
LED Wandleuchte
Настенные светильники светодиодный

cm 7,5 L x 10,5 P x 29 H

CE: V220 IP44 G9 3W 3000K

• 08 € 180,00

• 23 € 190,00



848

Applique a parete paralume P
Wall mounted applique lampshade P
Applique à mur abat-jour P
Wandleuchte Lampenglas P
Верхний светильник для зеркала P

cm 11 L x 14 P x 23 H

CE: V 220 IP44 40Wx1

• 08 € 139,00

• 16 - 25 € 179,00





1162



774



1062

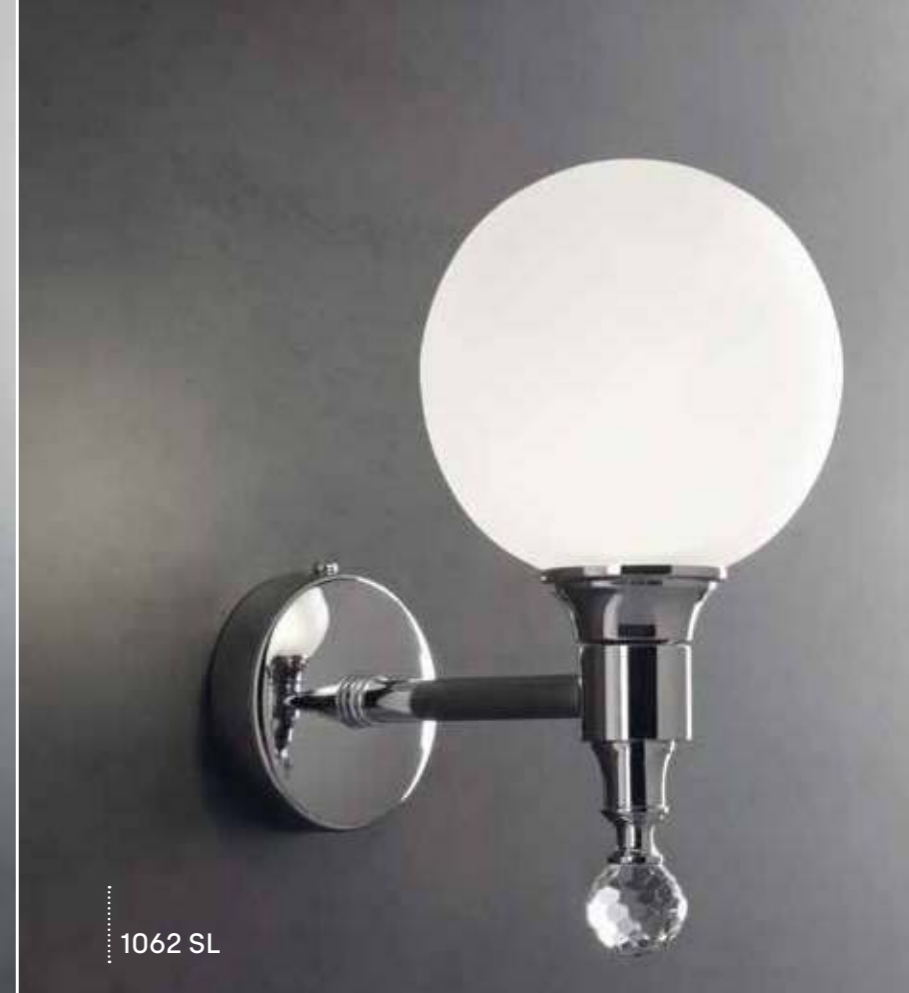

1062 SL

1162 MOON 1

Applique a parete
Wall mounted applique
Applique à mur
Wandleuchte

Верхний светильник для зеркала с фиксацией
cm 10 L x 13 P x 10,5 H

CE: V 220/12v IP44 G9 3W 3000K

- 08 - 23 € 95,00
- 16 - 25 € 130,00

774 MOON 2

Applique a parete
Wall mounted applique
Applique à mur
Wandleuchte

Верхний светильник для зеркала с фиксацией
cm 10,5 L x 15 P x 15 H

CE: V 220/12v IP44 G9 3W 3000K

- 08 € 135,00

B 03

Applique a parete paralume M
Wall mounted applique, lampshade M
Applique à mur, abat-jour M
Wandleuchte Lampenglas, Lampenglass M
Настенный светильник с абажуром регулируемый

cm 10 L x 10 P x 20 H

CE: V 220 IP44 60Wx1

- 08 € 95,00



B 03



504



> PAG. 315

1062 LED

Applique a parete
Wall mounted applique
Applique à mur
Wandleuchte

Настенные светильники
cm Ø 10 x 19 P x 20 H

CE: V 220 IP44 G9 3W 3000K

- 08 € 165,00
- 16 - 25 € 205,00

1062 SL LED

Applique a parete con finale cristallo
Wall sconce with crystal finish
Applique murale avec finition en cristal
Wandleuchter mit Kristall-Finish

Настенный брашлет с хрустальной отделкой
cm Ø 10 x 19 P x 20 H

CE: V 220 IP44 G9 3W 3000K

- 08 € 175,00
- 16 - 25 € 210,00

504

Applique alogena
Applique alogen
Applique halogène
Wandleuchte Halogenlampen
Настенный светильник с регулируемой лампой

cm Ø 10

CE: V 220/12v IP20 G4 20Wx3

- 08 € 230,00

ILLUMINAZIONE

EL 03 ELITE

Applique a parete, paralume Z
Wall mounted applique, lampshade Z
Applique à mur, abat-jour Z
Wandleuchte, Lampenglass Z
Настенные лампы с абажуром
cm 14 L x 15 P x 15 H

CE: V 220 IP44 40Wx1

• 08	€ 135,00
• 02 - 03 - 04	€ 148,00
• 16 - 25 - 26	€ 169,00



EL 03.2 ELITE

Applique doppia, paralume Z
Applique with 2 lamps, lampshade Z
Applique avec 2 lampe, abat-jour Z
Wandleuchte doppelt, Lampenglass Z
Настенные 2 лампы с абажуром
cm 36 L x 15 P x 16 H

CE: V 220 IP44 40Wx2

• 08	€ 210,00
• 02	€ 235,00
• 16 - 25 - 26	€ 275,00



B

I

> PAG. 337



ILLUMINAZIONE

i 824 IDRA LED

Applique a parete
Wall mounted applique
Applique à mur
Wandleuchte
Настенный светильник с абажуром
cm 10,5 L x 24 P x 22 H

CE: V 220 IP44 G9 3W 3000K

• 08	€ 159,00
• 16 - 25	€ 199,00



i 03 IDRA

Applique a parete paralume B
Wall mounted applique, lampshade B
Applique à mur, abat-jour B
Wandleuchte Lampenglas, Lampenglass B
Настенный светильник с абажуром
cm 10 L x 24 P x 22 H

CE: V 220 IP44 40Wx1

• 08	€ 145,00
• 16 - 25	€ 179,00



915 NE

Applique a parete
Wall mounted applique
Applique à mur
Wandleuchte

Настенные светильники
cm 15 L x 15 P x 24 H

CE: V 220 IP44 40Wx1

- 08 € 155,00
- 16 - 25 € 175,00



915 NE

915 BI

Applique a parete
Wall mounted applique
Applique à mur
Wandleuchte

Настенные светильники
cm 15 L x 15 P x 24 H

CE: V 220 IP44 40Wx1

- 08 € 150,00
- 16 - 25 € 170,00



915 BI

1125 BI

Applique a parete ventola bianco
Wall mounted applique
Applique à mur
Wandleuchte

Настенные светильники
cm 9 L x 15 P x 26 H x 22 B

CE: V 220 IP20 40Wx1

- 08 € 125,00
- 16 - 25 € 159,00



1125 VE

1125 VE

Applique a parete ventola verde
Wall mounted applique
Applique à mur
Wandleuchte

Настенные светильники
cm 9 L x 15 P x 26 H x 22 B

CE: V 220 IP20 40Wx1

- 08 € 125,00
- 16 - 25 € 159,00



1125 BI

MOD. B

Vetro sabbato
Sand glass
Verre sablé
Milchglas
Абажур (матовое стекло)
cm Ø 13 x 10 P

- B € 19,00



MOD. I

Ceramica bianca
White ceramic
Céramique blanc
Weiße Keramik
Белый керамический
cm Ø 15 x 10 P

- Bianco / white / blanc / weiß / белый € 23,00
- Con applique (maggiorazione)
With applique (supplement)
Avec applique (supplément)
Mit Wandleuchte (Zuschlag)
С аппликацией (за дополнительную плату) € 9,00



MOD. U

Vetro di Murano in diversi colori
Murano's glass in various colors
Verre de Murant en divergés couleurs
Muranglas in verschiedenen Farben
Мурано стекло различных цветов
cm Ø 3 x 4 H

- U € 18,00



MOD. Z

Vetro satinato
Satinated glass
Verre satiné
Satinieretes Glas
Абажур матовое стекло
cm Ø 13 x 10 P

- z € 19,00



TERMOARREDI E PLACCHE

Designer: STILHAUS

Materiale: ottone, Tubo Ø28, basetta a muro Ø 70
Finitura: 08-16-25
Fuori misura: Sì
- in larghezza, con aumento del 10% dal prezzo di listino
- in altezza, a preventivo
- con aggiunta di elementi, a preventivo

Material: Brass tube Ø 28, fixing plate cover Ø 70
Finishes: 08-16-25
Customized: Yes
- in width, with a 10% increase from the price list
- in height, to quote
- with the addition of element, to quote

Matière: Laiton, tuyau Ø 28, boucle couvre-vis Ø 70
Finitions: 08- 6-25
Personnalisé: Oui
- en largeur, avec une augmentation de 10% du prix de list
- hauteur, faire une estimation
- avec des éléments ajoutés, faire une estimation

Material: Messing Rohr Ø28, Angriff Ø70
Zubehör: Mattglas
Ausführungen: 08-16-25
Kundenwunsch: Ja
- die Breite mit 10% Preisaufschlag
- die Höhe gegen Kostenvoranschlag
- zusätzliche Elemente gegen Kostenvoranschlag

Материал: латунь
Варианты цвета: 08-16-25
Варианты под заказ:
По ширине, с увеличением на 10% от цены прайс-листа
по высоте, по запросу
с добавлением элементов, по запросу

1020

Scalda asciugamani in ottone a parete, versione acqua calda
 Brass wall towel warmer, hot water version
 Warmwasser-Wandhandtuchwärmer aus Messing, Warmwasser-Version
 Полотенцесушитель водяной, латунь
 Cm 60 H x 57 L x 14 P Int 50
 Δ 50°C 165 KCAL/H

• 08	€ 1.280,00
• 25-16	€ 1.650,00

1020 E

Scalda asciugamani in ottone a parete, versione elettrica 270 W
 Brass wall towel warmer, electric version 270 W
 Warmwasser-Wandhandtuchwärmer aus Messing, elektrische Version (270W)
 Полотенцесушитель электрический 270 W, латунь
 Cm 60 H x 57 L x 14 P Int 50
 Δ 50°C 180 W

• 08	€ 1.520,00
• 25-16	€ 1.743,00

1024

Valvola e detentore completi
 Valve and lockshield
 Ventile und Drossel
 клапана и вентеля в комплекте

• 08	€ 330,00
• 25-16	€ 460,00

1025

Tubetti di collegamento
 Connecting pipes
 Verbindungsstücke
 трубки для подключения

• 08	€ 68,00
• 25-16	€ 92,00

1026

Termostato
 Thermostat
 Thermostat
 Терморегулятор

• 01	€ 135,00
------	----------

1027

Cover con interruttore
 Cover with switch
 Couverture avec interrupteur
 Крышка с выключателем

• 08	€ 360,00
• 25-16	€ 440,00



1021

Scalda asciugamani in ottone a parete, versione acqua calda
 Brass wall towel warmer, hot water version
 Warmwasser-Wandhandtuchwärmer aus Messing, Warmwasser-Version
 полотенцесушитель водяной, латунь
 Cm 80 H x 57 L x 14 P Int 50
 Δ 50°C 270 KCAL/H

• 08	€ 1.660,00
• 25-16	€ 2.050,00

1021 E

Scalda asciugamani in ottone a parete, versione elettrica 270 W
 Brass wall towel warmer, electric version 270 W
 Warmwasser-Wandhandtuchwärmer aus Messing, elektrische Version (270W)
 полотенцесушитель электрический 270 W, латунь
 Cm 80 H x 57 L x 14 P Int 50
 Δ 50°C 285 W

• 08	€ 1.940,00
• 25-16	€ 2.180,00

1024

Valvola e detentore completi
 Valve and lockshield
 Ventile und Drossel
 клапана и вентеля в комплекте

• 08	€ 330,00
• 25-16	€ 460,00

1025

Tubetti di collegamento
 Connecting pipes
 Verbindungsstücke
 трубки для подключения

• 08	€ 68,00
• 25-16	€ 92,00

1026

Termostato
 Thermostat
 Thermostat
 Терморегулятор

• 01	€ 135,00
------	----------

1027

Cover con interruttore
 Cover with switch
 Couverture avec interrupteur
 Крышка с выключателем

• 08	€ 360,00
• 25-16	€ 440,00



1024

1025

1022

Scalda asciugamani in ottone a parete, versione acqua calda
 Brass wall towel warmer, hot water version
 Warmwasser-Wandhandtuchwärmer aus Messing, Warmwasser-Version
 Полотенцесушитель водяной, латунь
 Cm 120 H x 57 L x 14 P Int 50
 Δ 50°C 345 KCAL/H

• 08	€ 2.050,00
• 25-16	€ 2.550,00

1022 E

Scalda asciugamani in ottone a parete, versione elettrica 270 W
 Brass wall towel warmer, electric version 270 W
 Warmwasser-Wandhandtuchwärmer aus Messing, elektrische Version (270W)
 Полотенцесушитель электрический 270 W, латунь
 Cm 120 H x 57 L x 14 P Int 50
 Δ 50°C 360 W

• 08	€ 2.300,00
• 25-16	€ 2.900,00

1024

Valvola e detentore completi
 Valve and lockshield
 Ventile und Drossel
 клапана и вентеля в комплекте

• 08	€ 330,00
• 25-16	€ 460,00

1025

Tubetti di collegamento
 Connecting pipes
 Verbindungsstücke
 трубки для подключения

• 08	€ 68,00
• 25-16	€ 92,00

1026

Termostato
 Thermostat
 Thermostat
 Терморегулятор

• 01	€ 135,00
------	----------

1027

Cover con interruttore
 Cover with switch
 Couverture avec interrupteur
 Крышка с выключателем

• 08	€ 360,00
• 25-16	€ 440,00



TERMO A

Scalda asciugamani BASE in ottone a parete
 BASE Brass wall towel warmer, hot water version
 Chauffe-serviettes BASE en laiton monté au mur
 Warmwasser-Wandhandtuchwärmer aus Messing, Warmwasser-Version
 Полотенцесушитель водяной, латунь
 Cm 50/ 120 H x 40 / 60 L x 10/ 14 P

• 08	€ 1.050,00
• 25-16	€ 1.320,00



TERMO B

Tubo con giunti in ottone
 Pipe with brass joints
 Tube avec raccords en laiton
 Rohr mit Messingverbindungen
 Труба с латунными швами
 Cm 20 H min x 40 / 60 L

• 08	€ 240,00
• 25-16	€ 320,00

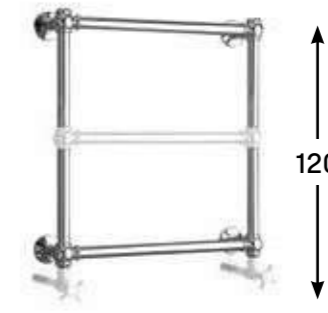

TERMO H

Altezza superiore a cm 120
 Height greater than 120 cm
 Hauteur supérieure à 120 cm
 Höhe größer als 120 cm
 Высота более 120 см
 Cm 120/ 160 H x 40 / 60 L x 10/ 14 P

• 08	€ 125,00
• 25-16	€ 290,00



TERMO EL

Resistenza elettrica
 Electrical resistance
 Résistance électrique
 Elektrischer Widerstand
 Электрическое сопротивление

• 08	€ 230,00
------	----------



1024

Valvola e detentore completi
 Valve and lockshield
 Ventile und Drossel
 клапана и вентеля в комплекте

• 08	€ 330,00
• 25-16	€ 460,00



1025

Tubetti di collegamento
 Connecting pipes
 Verbindungsstücke
 трубки для подключения

• 08	€ 68,00
• 25-16	€ 92,00



1027

Cover con interruttore
 Cover with switch
 Couverture avec interrupteur
 Крышка с выключателем

• 08	€ 360,00
• 25-16	€ 440,00



1026

Termostato
 Thermostat
 Thermostat
 Терморегулятор

• 01	€ 135,00
------	----------

ESEMPIO Termoarredo 5 tubi cromo elettrico con cover Cm 95 H x 55 L
EXAMPLE Chrome electric 5 tubes thermo-furnishing with cover
EXEMPLE Chrome électrique 5 tubes thermo-aménagement avec couvercle
BEISPIEL Verchromte elektrische 5-Röhren-Thermomöbel mit Deckel
Пример Хромированный электрический 5-трубчатый радиатор с крышкой

A	TERMO A	08	€ 1.050,00
B	TERMO B	08	€ 240,00 x3
A	TERMO EL		€ 230,00
A	1027	08	€ 360,00
			TOT € 2.360,00



A

+



B

+



C

+

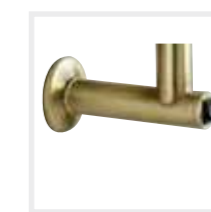

D

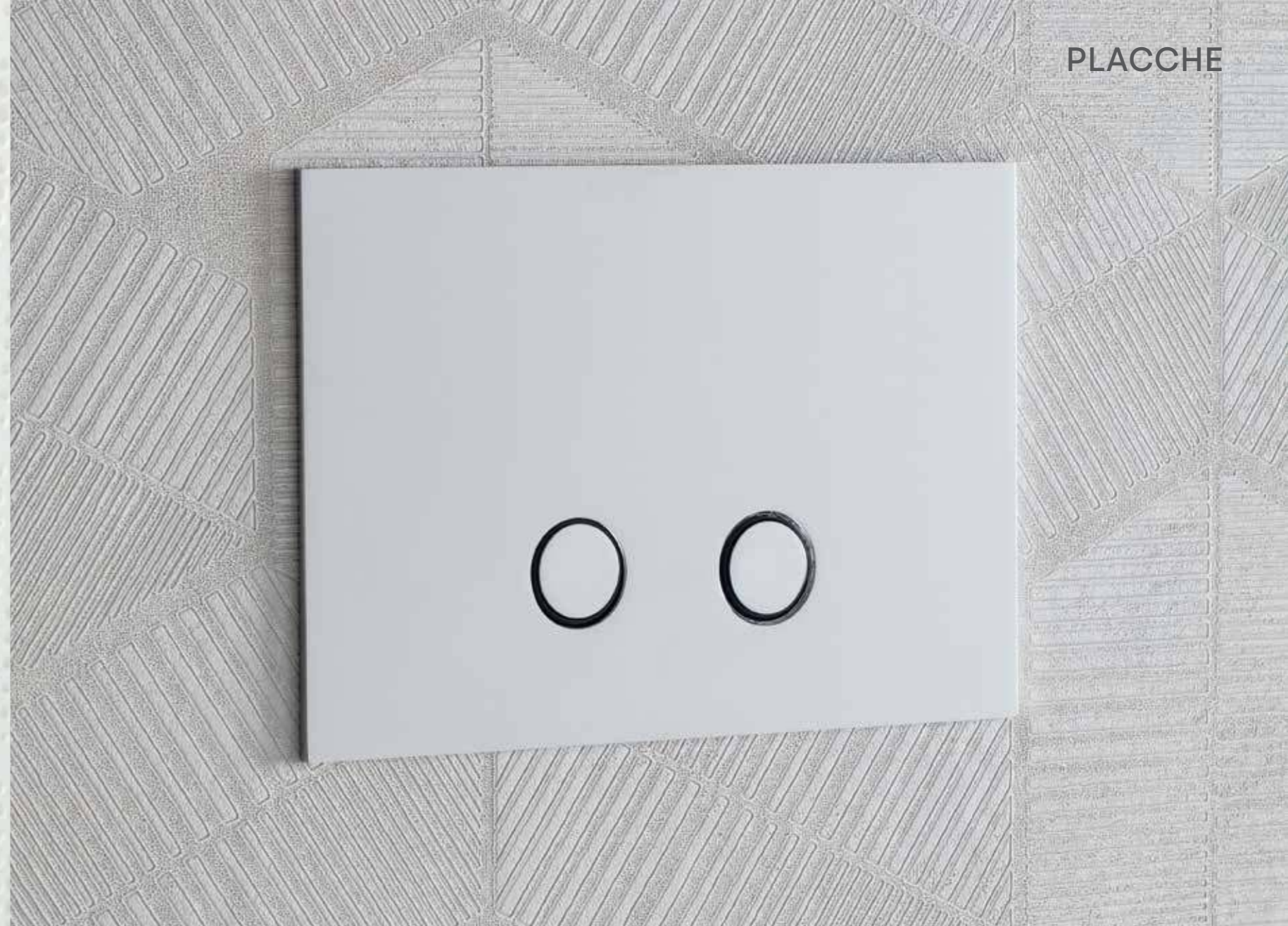

1098

Placca comando per cassetta incasso mod. Geberit, compatibile con Sigma 8, Unica+, Combifix e Duofix dotate del corpo cassetta UP320 o simili
 Plate for Geberit Waste System featuring with Sigma 8, Unica+, Combifix e Duofix that mounted body UP320 or similar
 Drückerplatte für Geberit Installationssysteme (Sigma 8, Unica+, Combifix und Duofix), die mit UP320 Kassettengehäuse oder ähnlichem ausgestattet sind.
 Клавиша смыва для бачков скрытого монтажа Geberit Sigma 8, Unica+, Combifix e Duofix установленных в бачки UP320 или подобные
 cm 33LxP2,5xH7

• 08	€ 490,00
• 12 - 16 - 25	€ 630,00
• FN	€ 730,00



12



16



25



Placca comando per cassetta incasso compatibile con:
 mod. Geberit: Sigma 8, Unica+, Combifix e Duofix dotate del corpo cassetta UP320 o simili.
 mod. Tece Octa II.
 Control plate for built-in cistern, compatible with:
 Geberit Water (System featuring with Sigma 8, Unica+, Combifix e Duofix that mounted body UP320 or similar)
 Tece Octa II.
 Bedienplatte für Einbauspülkasten, kompatibel mit: Geberit Installationssysteme (Sigma 8, Unica+, Combifix und Duofix), die mit UP320 Kassettengehäuse oder ähnlichem ausgestattet sind. Tece Octa II.
 cm. 25 L x 17 H x 0,5 P

• 1316	08 - 23 - 24	€ 390,00
• 1316	FN	€ 590,00
• 1316TECE	08 - 23 - 24	€ 390,00
• 1316TECE	FN	€ 590,00



27 - FN



FN*

PROGETTO SARTORIA
 Tailoring project
 Finishes on request
 finitions sur demande
 Ausführungen auf Anfrage
 отделка по запросу



72 - FNPVD

FNPVD**

PROGETTO SARTORIA PVD +80% DAL 08
 Tailoring project PVD
 increase +80% on 08
 augmentation +80% sur 08
 Steigerung +80 % auf 08
 рный матовый



PIANTANE E COLONNE ATTREZZATE

Designer: STILHAUS, GIANLUCA PALUDI

Fuori misura: Sì
Customized: Yes
Personnalisé: Oui
Kundenspezifische: Ja
Негабаритный: да

PIANTANE



PIANTANE

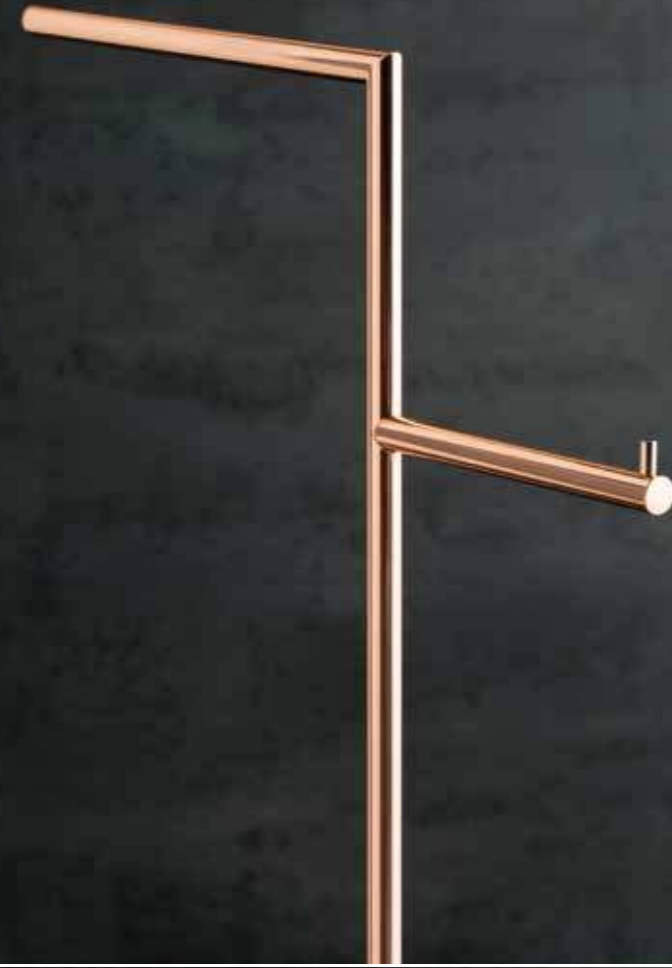

1239

1244



1244

1242



1239

1244



1239

1242



EQUILIBRIUM MARMO brass and marble

realizzata in ottone / realized in brass / réalisée en laiton / aus Messing hergestellt / Сделано из латуни

Designer Gianluca Paludi



1239

Piantana: porta rotolo e scopino
Free-standing upright: paper holder and toilet-brush holder
Montant autonome: porte rouleau et porte balayent
Ständer: Papierrollenhalter und Bürstengarnitur
Стойка: бумагодержатель+ерш
металлический
cm Ø 12 x 14,5 L x 56 H

• 08 - 23	€ 430,00
• 10 - 18 - 36 - 56	€ 500,00
• FN	€ 570,00

1240

Piantana: porta rotolo
Free-standing upright: paper holder
Support : porte-rouleau
Ständer: Rollenhalter
Подставка: держатель рулона
cm Ø 12 x 14,5 L x 56 H

• 08 - 23	€ 400,00
• 10 - 18 - 36 - 56	€ 480,00
• FN	€ 520,00

1241

Piantana: porta rotolo, porta salviette e scopino
Free-standing upright: paper holder, towel rail and toilet-brush holder
Unité autonome : porte-rouleau de papier toilette, porte-serviette et brosse de toilette
Freistehende Einheit: Toilettenpapierhalter, Handtuchhalter und Toilettenbürste
Отдельно стоящее устройство: держатель рулона туалетной бумаги, полотенцедержатель и туалетный ершик
cm Ø 12 x 36 L x 80 H

• 08 - 23	€ 510,00
• 10 - 18 - 36 - 56	€ 580,00
• FN	€ 640,00

1242

Piantana: porta rotolo e porta salviette
Free-standing upright: paper holder and Towel rail
Sur pied : porte-rouleau de papier toilette et porte-serviette
Stehleuchte: Toilettenpapier- und Handtuchhalter
Напольный светильник: держатель для туалетного рулона и полотенца
cm Ø 12 x 36 L x 80 H

• 08 - 23	€ 490,00
• 10 - 18 - 36 - 56	€ 570,00
• FN	€ 630,00

1243

Piantana: scopino, dosatore sapone, porta asciugamani e porta rotolo
Free-standing upright: toilet brush holder, soap dispenser, towel holder and paper holder
Montant autonome: porte balayent, doseur de savon, porte serviette et porte rouleau
Ständer: Bürstengarnitur, Flüssigseifenspender, Handtuchhalter und Papierrollenhalter
Стойка: мылница + полотенцедержатель + бумагодержатель + ёрш металлический
cm Ø 12 x 36 L x 84 H

• 08 - 23	€ 620,00
• 10 - 18 - 36 - 56	€ 700,00
• FN	€ 780,00

1244

Piantana porta asciugamani
Free-standing upright towel rail
Porte-serviettes
Handtuchhalter
Подставка для полотенца
cm Ø 12 x 45 L x 80 H

• 08 - 23	€ 480,00
• 10 - 18 - 36 - 56	€ 580,00
• FN	€ 640,00

** FINITURA DISPONIBILE IN 20 GG.
Finish available in 20 days
Finition disponible en 20 jours
Oberfläche lieferbar in 20 Tagen
Отделка доступна в течение 20 дней



08

10**

56**



18**

23

36



FN**

PROGETTO SARTORIA
Tailoring project
Finishes on request
finitions sur demande
Ausführungen auf Anfrage
отделка по запросу

EQUILIBRIUM RESINA Brass and resin

realizzata in ottone / realized in brass / réalisée en laiton / aus Messing hergestellt / Сделано из латуни

Designer Gianluca Paludi



1302

Piantana: porta rotolo e scopino
 Freestanding unit: toilet roll holder and toilet brush
 Lampadaire : porte-rouleau de papier toilette et brosse de toilette
 Stehleuchte: Toilettenpapierhalter und Toilettenbürste
 Напольный светильник: держатель для туалетного рулона и щетка для унитаза
 cm Ø 12 x 14,5 L x 56 H

• 10 -	€ 270,00
• 10 - 18 - 36 - 56	€ 340,00
• FN	€ 420,00

1303

Piantana: porta rotolo
 Free-standing upright: paper holder
 Support : porte-rouleau
 Ständer: Rollenhalter
 Подставка: держатель рулона
 cm Ø 12 x 14,5 L x 56 H

• 08 - 23	€ 240,00
• 10 - 18 - 36 - 56	€ 320,00
• FN	€ 360,00

1304

Piantana: porta rotolo, porta salviette e scopino.
 Free-standing upright: paper holder, towel rail and toilet-brush holder.
 Unité autonome : porte-rouleau de papier toilette, porte-serviette et brosse de toilette
 Handtuchleiter
 полотенцедержатель напольный
 cm Ø 12 x 36 L x 80 H

• 08 - 23	€ 360,00
• 10 - 18 - 36 - 56	€ 440,00
• FN	€ 580,00

1305

Piantana: porta rotolo e porta salviette
 Free-standing upright: paper holder and Towel rail
 Sur pied : porte-rouleau de papier toilette et porte-serviette
 Stehleuchte: Toilettenpapier- und Handtuchhalter
 Напольный светильник: держатель для туалетного рулона и полотенца
 cm Ø 12 x 36 L x 80 H

• 08 - 23	€ 340,00
• 10 - 18 - 36 - 56	€ 420,00
• FN	€ 490,00

1306

Piantana: scopino, dosatore sapone, porta asciugamani e porta rotolo
 Free-standing upright: toilet brush holder, soap dispenser, towel holder and paper holder
 Montant autonome: porte balaynet, doseur de savon, porte serviette et porte rouleau
 Ständer: Bürstengarnitur, Flüssigseifenspender, Handtuchhalter und Papierrollenhalter
 Стойка: мыльница + полотенцедержатель + бумагодержатель + ёрш металлический
 cm Ø 12 x 36 L x 84 H

• 08 - 23	€ 460,00
• 10 - 18 - 36 - 56	€ 550,00
• FN	€ 650,00

1307

Piantana porta asciugamani
 Free-standing upright towel rail
 Porte-serviettes
 Handtuchhalter
 Подставка для полотенца
 cm Ø 12 x 45 L x 80 H

• 08 - 23	€ 340,00
• 10 - 18 - 36 - 56	€ 420,00
• FN	€ 490,00

** FINITURA DISPONIBILE IN 20 GG.
 Finish available in 20 days
 Finition disponible en 20 jours
 Oberfläche lieferbar in 20 Tagen
 Отделка доступна в течение 20 дней

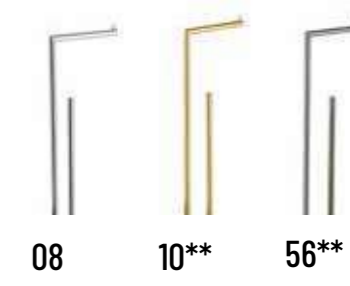

FN** PROGETTO SARTORIA
 Tailoring project
 Finishes on request
 finitions sur demande
 Ausführungen auf Anfrage
 отделка по запросу

NEOP

RESINA NERO OPACO
 Matt black resin
 Résine Noir mat
 Mattschwarz Harz
 черная матовая смола



Disponibili in neolite opaco (maggiorazione)
 Available in matt neolite (supplement)
 Disponible en néolite mat (supplément)
 Erhältlich in mattem Neolith (Zuschlag)
 Доступен в матовом неолитовом цвете (дополнительно)

€ 25,00

EQUILIBRIUM OTTONE TOTAL BRASS

realizzata in ottone / realized in brass / réalisée en laiton / aus Messing hergestellt / Сделано из латуни

Designer Gianluca Paludi

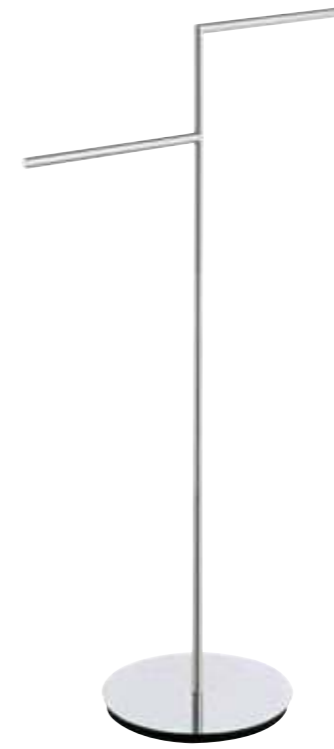

1246

Piantana: porta rotolo e scopino
Free-standing upright: paper holder and toilet-brush holder
Montant autonome: porte rouleau et porte balayent
Ständer: Papierrollenhalter und Bürstengarnitur
Стойка: бумагодержатель+ерш металлический
cm Ø 13 x 14,5 L x 56 H

• 08 - 23	€ 230,00
• 10 - 18 - 36 - 56	€ 290,00
• FN	€ 345,00

1247

Piantana: porta rotolo
Stand: roll holder
Support: porte-rouleau
Ständer: Rollenhalter
Подставка: держатель рулона
cm Ø 13 x 14,5 L x 56 H

• 08 - 23	€ 155,00
• 10 - 18 - 36 - 56	€ 210,00
• FN	€ 230,00

1248

Piantana: porta rotolo, porta salviette e scopino.
Free-standing upright: paper holder, towel rail and toilet-brush holder.
Unité autonome: porte-rouleau de papier toilette, porte-serviette et brosse de toilette
Handtuchleiter
полотенцедержатель напольный
cm Ø 17 x 36 L x 78 H

• 08 - 23	€ 300,00
• 10 - 18 - 36 - 56	€ 390,00
• FN	€ 450,00

1249

Piantana: porta rotolo e porta salviette
Free-standing upright: paper holder and Towel rail
Sur pied: porte-rouleau de papier toilette et porte-serviette
Stehleuchte: Toilettenpapier- und Handtuchhalter
Напольный светильник: держатель для туалетного рулона и полотенца
cm Ø 17 x 36 L x 79 H

• 08 - 23	€ 230,00
• 10 - 18 - 36 - 56	€ 305,00
• FN	€ 345,00

1250

Piantana: scopino ottone, dosatore sapone, porta asciugamani e porta rotolo
Free-standing upright: toilet brush holder, soap dispenser, towel holder and paper holder
Montant autonome: porte balayent, porte savon liquid, porte serviette et porte rouleau
Ständer: Bürstengarnitur, Seifenschale, Handtuchhalter und Papierrollenhalter
Стойка: мывница + полотенецедержатель + бумагодержатель + ёрш металлический
cm Ø 17 x 36 L x 84 H

• 08 - 23	€ 400,00
• 10 - 18 - 36 - 56	€ 560,00
• FN	€ 600,00

1251

Piantana porta asciugamani
Towel stand
Porte-serviettes
Handtuchhalter
Подставка для полотенца
cm Ø 22 x 45 L x 79 H

• 08 - 23	€ 265,00
• 10 - 18 - 36 - 56	€ 345,00
• FN	€ 375,00

** FINITURA DISPONIBILE IN 20 GG.
Finish available in 20 days
Finition disponible en 20 jours
Oberfläche lieferbar in 20 Tagen
Отделка доступна в течение 20 дней

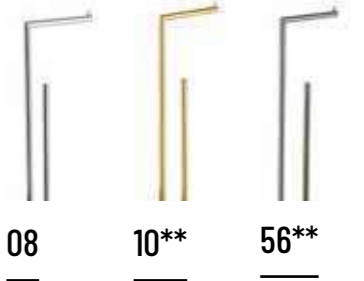

FN** PROGETTO SARTORIA
Tailoring project
Finishes on request
finitions sur demande
Ausführungen auf Anfrage
отделка по запросу



HASHI

realizzata in ottone / realized in brass / réalisée en laiton / aus Messing hergestellt / Сделано из латуни



972

Piantana: porta rotolo e scopino ceramica
Free-standing upright: paper holder
and toilet-brush holder
Montant autonome: porte rouleau et porte
balayent
Ständer: Papierrollenhalter und Bürstengarnitur
Стойка: бумагодержатель +
ерш металлический керамика
base cm Ø 13 x 62 H

• 08 - 23 - 24	€ 180,00
• 18 - 56	€ 240,00
• FN	€ 270,00



971

Piantana: scopino ottone, porta sapone, porta
asciugamani e porta rotolo
Free-standing upright: toilet brush holder, soap
dish, towel holder and paper holder
Montant autonome: porte balayent, porte
savon, porte serviette et porte rouleau
Ständer: Bürstengarnitur, Seifenschale,
Handtuchhalter und Papierrollenhalter
Стойка: мыльница + полотенцедержатель +
бумагодержатель + ёрш металлический
base cm Ø 13 x 73 H

• 08 - 23 - 24	€ 298,00
• 18 - 56	€ 395,00
• FN	€ 445,00

* Con dosatore sapone liquido (maggiorazione) € 28,00
With liquid soap dispenser (supplement)
Avec doseur de savon liquid (supplément)
Mit Seifenspender (Zuschlag)
с дозатором (дополнительно)



969

Piantana: porta rotolo e scopino ottone
Free-standing upright: paper holder toilet-brush
Montant autonome: porte rouleau et porte
balayent
Ständer: Papierrollenhalter und Bürstengarnitur
Стойка: бумагодержатель + ерш металлический
base cm Ø 13 x 63 H

• 08 - 23 - 24	€ 189,00
• 18 - 56	€ 265,00
• FN	€ 285,00

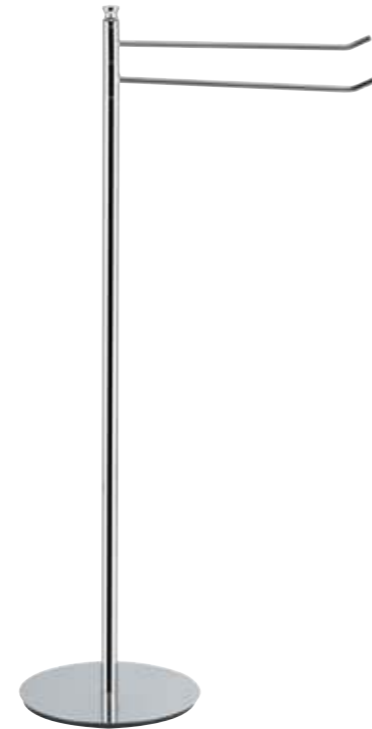

1123

Piantana con 2 portasciugamani
Free-standing upright with 2 towel holders
Montant autonome avec 2 porte serviette
Handtuchständer 2 armig
Стойка для 2-ух полотенец
cm 81,5 H - 29 L • Base Ø 22

• 08 - 23 - 24	€ 189,00
• 18 - 56	€ 265,00
• FN	€ 285,00

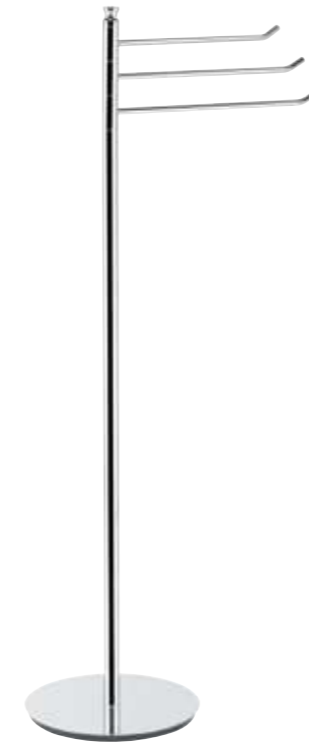

1123/3

Piantana con 3 portasciugamani
Free-standing upright with 3 towel holders
Montant autonome avec 3 porte serviette
Handtuchständer 3 armig
Стойка для 3-ух полотенец
cm 85,5 H - 29 L • Base Ø 22

• 08 - 23 - 24	€ 235,00
• 18 - 56	€ 305,00
• FN	€ 350,00

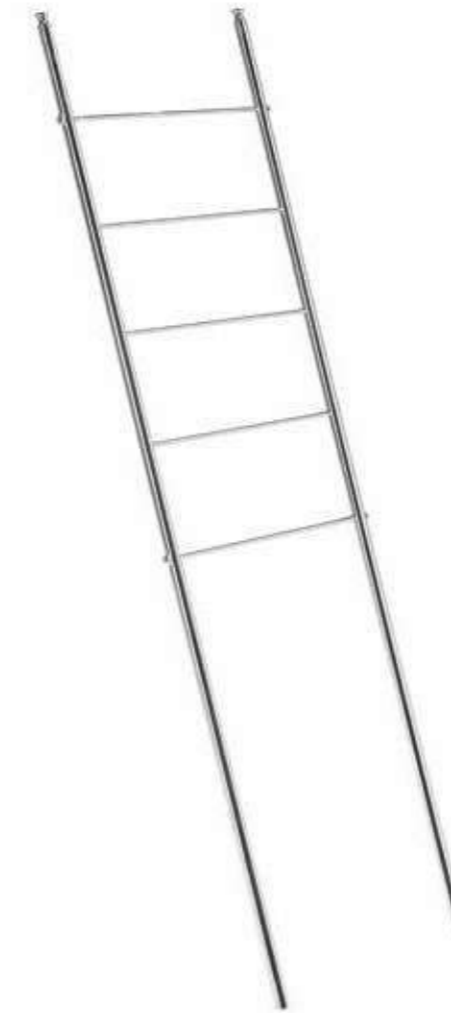

1189

Scaletta portaserviette
Ladder towel holder
Escalier porte serviettes
Handtuchleiter
полотенцедержатель напольный
cm 40 L x 142 H

• 08 - 23 - 24	€ 260,00
• 18 - 56	€ 320,00
• FN	€ 390,00

** FINITURA DISPONIBILE IN 20 GG.
Finish available in 20 days
Finition disponible en 20 jours
Oberfläche lieferbar in 20 Tagen
Отделка доступна в течение 20 дней



18**

23



24

56**



FN*

PROGETTO SARTORIA
Tailoring project
Finishes on request
finitions sur demande
Ausführungen auf Anfrage
отделка по запросу



*

MEDEA

realizzata in ottone / realized in brass / réalisée en laiton / aus Messing hergestellt / Сделано из латуни



ME 972

Piantana: porta rotolo e scopino ceramica
Free-standing upright: paper holder and toilet-brush holder
Montant autonome: porte rouleau et porte balayent en ceramique
Ständer: Papierrollenhalter und Bürstengarnitur aus Keramik
Стойка: бумагодержатель+ерш керамический
base cm Ø 13 x 64 H

• 08 - 23	€ 180,00
• 16 - 18 - 36	€ 240,00
• FN	€ 270,00



ME 20

Piantana: porta rotolo e scopino
Free-standing upright: paper holder and toilet-brush holder
Montant autonome: porte rouleau et porte balayent
Ständer: Papierrollenhalter und Bürstengarnitur
Стойка: бумагодержатель+ерш металлический
base cm Ø 13 x 62 H

• 08 - 23	€ 240,00
• 16 - 18 - 36	€ 310,00
• FN	€ 360,00



ME 21

Piantana: scopino, porta sapone, porta asciugamani e porta rotolo
Free-standing upright: toilet brush holder, soap dish, towel holder and paper holder
Montant autonome: porte balayent, porte savon, porte serviette et porte rouleau
Ständer: Bürstengarnitur, Seifenschale, Handtuchhalter und Papierrollenhalter
Стойка: ёрш металлический+ мьльница+бумагодержатель+полотенцедержатель
base cm Ø 17 x 88 H

• 08 - 23	€ 370,00
• 16 - 18 - 36	€ 450,00
• FN	€ 550,00

* • Con dosatore sapone liquido (maggiorazione) € 35,00
With liquid soap dispenser (supplement)
Avec doseur de savon liquide (supplément)
Mit Seifenspender (Zuschlag)
с дозатором (дополнительно)



ME 19

Piantana con 2 portasciugamani
Free-standing upright with 2 towel holders
Montant autonome avec 2 porte serviette
Handtuchständer 2 armig
Стойка для 2-ух полотенец
base cm Ø 22 / 81 H - 28/30 L

• 08 - 23	€ 245,00
• 16 - 18 - 36	€ 320,00
• FN	€ 370,00



1158

Cavalletto portasciugamani
Free-standing towel holders
Montant autonome porte serviette
Handtuchständer
полотенцедержатель напольный
cm 60 L x 20 P x 91 H

• 08 - 23	€ 460,00
• 16 - 18 - 36	€ 595,00
• FN	€ 660,00

** FINITURA DISPONIBILE IN 20 GG.
Finish available in 20 days
Finition disponible en 20 jours
Oberfläche lieferbar in 20 Tagen
Отделка доступна в течение 20 дней



16**

18**



23

36**



FN*

PROGETTO SARTORIA
Tailoring project
finishes on request
finitions sur demande
Ausführungen auf Anfrage
отделка по запросу



URANIA

realizzata in ottone / realized in brass / réalisée en laiton / aus Messing hergestellt / Сделано из латуни



U 20

Piantana: porta rotolo e scopino ceramica
Free-standing upright: paper holder
and toilet-brush holder
Montant autonome: porte rouleau et
porte balayent en ceramique
Ständer: Papierrollenhalter und
Bürstengarnitur aus Keramik
Стойка: бумагодержатель + ёрш керамический
base cm 16 L x 13 P x 66 H

• 08 - 23	€ 335,00
• 36	€ 410,00
• FN	€ 495,00

U 20 M

Piantana: porta rotolo e scopino ottone
Free-standing upright: paper holder
and toilet-brush holder brass
Montant autonome: porte rouleau et porte
balayent en laiton
Ständer: Papierrollenhalter und
Bürstengarnitur aus Messing
Стойка: ёрш металлический+
бумагодержатель
base cm 13 L x 16 P x 66 H

• 08 - 23	€ 365,00
• 36	€ 460,00
• FN	€ 550,00

U 21

Piantana: scopino ceramica, p. sapone,
p. asciugamani e p. rotolo
Free-standing upright: toilet brush holder,
soap dish, towel holder and paper holder
Montant autonome: porte balayent,
porte savon, porte serviette et porte rouleau
Ständer: Bürstengarnitur, Seifenschale,
Handtuchhalter und Papierrollenhalter
Стойка: ёрш керамический+
мыльница+бумагодержатель+
полотенцедержатель
base cm 16 L x 13 P x 76 H

• 08 - 23	€ 440,00
• 36	€ 560,00
• FN	€ 660,00

* Con dosatore sapone liquido (maggiorazione) € 45,00
With liquid soap dispenser (supplement)
Avec doseur de savon liquid (supplément)
Mit Seifenspender (Zuschlag)
с дозатором (дополнительно)

U 21 M

Piantana: scopino ottone, p. sapone,
p. asciugamani e p. rotolo
Free-standing upright: toilet brush holder,
soap dish, towel holder and paper holder
Montant autonome: porte balayent,
porte savon, porte serviette et porte rouleau
Ständer: Bürstengarnitur, Seifenschale,
Handtuchhalter und Papierrollenhalter
Стойка: ёрш металлический+
мыльница+бумагодержатель+
полотенцедержатель
base cm 16 L x 13 P x 76 H

• 08 - 23	€ 495,00
• 36	€ 620,00
• FN	€ 740,00

* Con dosatore sapone liquido (maggiorazione) € 45,00
With liquid soap dispenser (supplement)
Avec doseur de savon liquid (supplément)
Mit Seifenspender (Zuschlag)
с дозатором (дополнительно)

U 19

Piantana con 2 portasciugamani
Free-standing upright with 2 towel holders
Montant autonome avec 2 porte serviette
Handtuchständer 2 armig
Стойка для 2-ух полотенец
base cm 20 L x 15 P x 81,5 H - 30/28 L

• 08 - 23	€ 310,00
• 36	€ 390,00
• FN	€ 470,00

780 URANIA

Scaletta portasalviette
Ladder towel holder
Escalier porte serviettes
Handtuchleiter
полотенцедержатель напольный
cm 42 L x 142 H x 7,5/15 P

• 08 - 23	€ 440,00
• 36	€ 530,00
• FN	€ 660,00

** FINITURA DISPONIBILE IN 20 GG.
Finish available in 20 days
Finition disponible en 20 jours
Oberfläche lieferbar in 20 Tagen
Отделка доступна в течение 20 дней



23

36**



DIANA

realizzata in ottone / realized in brass / réalisée en laiton / aus Messing hergestellt / Сделано из латуни



DI 20

Piantana: porta rotolo e scopino
Free-standing upright: paper holder
and toilet-brush holder
Montant autonome: porte rouleau et
porte balayent
Ständer: Papierrollenhalter und Bürstengarnitur
Стойка: бумагодержатель+ёрш металлический
base cm 16 L x 13 P x 62 H

• 08 € 320,00



DI 21

Piantana: scopino, porta sapone,
porta asciugamani e porta rotolo
Free-standing upright: toilet brush holder,
soap dish, towel holder and paper holder
Montant autonome: porte balayent,
porte savon, porte serviette et porte rouleau
Ständer: Bürstengarnitur, Seifenschale,
Handtuchhalter und Papierrollenhalter
Стойка: ёрш металлический+
мьльница+бумагодержатель+
полотенцедержатель
base cm 14 L x 16 P x 77 H

• 08 € 410,00

* Con dosatore sapone liquido (maggiorazione) € 35,00
With liquid soap dispenser (supplement)
Avec doseur de savon liquid (supplément)
Mit Seifenspender (Zuschlag)
с дозатором (дополнительно)



DI 19

Piantana con 2 portasciugamani
Free-standing upright with 2 towel holders
Montant autonome avec 2 porte serviette
Handtuchständer 2 armig
Стойка для 2-ух полотенец
base cm 20 L x 15 P x 83 H - 28/30 L

• 08 € 275,00



LV 20

Piantana: porta rotolo e scopino
Free-standing upright: paper holder
and toilet-brush holder
Montant autonome: porte rouleau et
porte balayent
Ständer: Papierrollenhalter und Bürstengarnitur
Стойка: бумагодержатель+ёрш металлический
base cm Ø 13 x 72,5 H

• 08-05-03 € 250,00



LV 21

Piantana: scopino, porta sapone,
porta asciugamani e porta rotolo
Free-standing upright: toilet brush holder,
soap dish, towel holder and paper holder
Montant autonome: porte balayent,
porte savon, porte serviette et porte rouleau
Ständer: Bürstengarnitur, Seifenschale,
Handtuchhalter und Papierrollenhalter
Стойка: ёрш металлический+
мьльница+бумагодержатель+
полотенцедержатель
base cm Ø 17 x 87 H

• 08-05-03 € 380,00

* Con dosatore sapone liquido (maggiorazione) € 45,00
With liquid soap dispenser (supplement)
Avec doseur de savon liquid (supplément)
Mit Seifenspender (Zuschlag)
с дозатором (дополнительно)

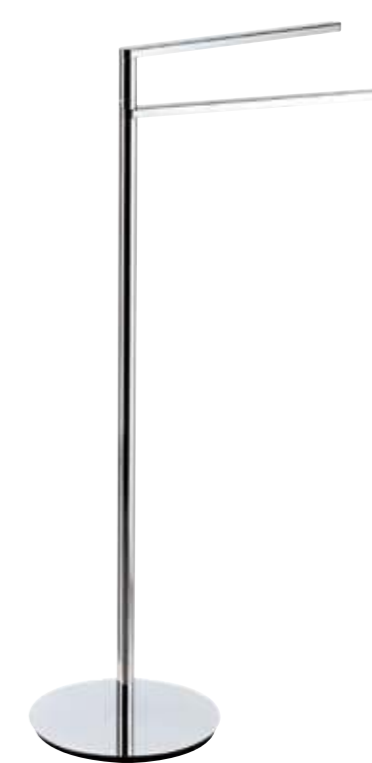

LV 19

Piantana con 2 portasciugamani
Free-standing upright with 2 towel holders
Montant autonome avec 2 porte serviette
Handtuchständer 2 armig
Стойка для 2-ух полотенец
base cm Ø 22 x 78,5 H - 28/30 L

• 08-05-03 € 275,00

* FINITURA DISPONIBILE IN 20 GG.
Finish available in 20 days
Finition disponible en 20 jours
Oberfläche lieferbar in 20 Tagen
Отделка доступна в течение 20 дней



03

05



LIZ

realizzata in ottone / realized in brass / réalisée en laiton / aus Messing hergestellt / Сделано из латуни



856

Piantana: porta rotolo e scopino
Free-standing upright: paper holder
and toilet-brush holder
Montant autonome: porte rouleau et porte balayent
Ständer: Papierrollenhalter und Bürstengarnitur
Стойка: 3 крючка под халаты и 3
полотенцедержателя
base cm Ø 17 x 62 H

• 08 € 230,00



857

Piantana: scopino, porta sapone, porta asciugamani e porta rotolo
Free-standing upright: toilet brush holder, soap dish, towel holder and paper holder
Montant autonome: porte balayent, porte savon, porte serviette et porte rouleau
Ständer: Bürstengarnitur, Seifenschale, Handtuchhalter und Papierrollenhalter
Стойка: ёрш металлический+ мыльница+бумагодержатель+полотенцедержатель
base cm Ø 17 x 72 H

• 08 € 330,00

* Con dosatore sapone liquido (maggiorazione)
With liquid soap dispenser (supplement)
Avec doseur de savon liquid (supplément)
Mit Seifenspender (Zuschlag)
с дозатором (дополнительно)



855

Piantana con 2 portasciugamani
Free-standing upright with 2 towel holders
Montant autonome avec 2 porte serviette
Handtuchständer 2 armig
Стойка для 2-ух полотенец
base cm Ø 22 x 88 H - 34 L

• 08 € 260,00



858

Piantana porta accappatoio con portasciugamani
Free-standing upright bathrobe with towel holders
Montant autonome peignoir avec porte serviette
Bademantelständer armig
Стойка: крючка под халаты и 3 полотенецдержателя
base cm Ø 22 x 176 H - 34 L

• 08 € 350,00



Q 20

Piantana: porta rotolo e scopino
Free-standing upright: paper holder
and toilet-brush holder
Montant autonome: porte rouleau et porte balayent
Ständer: Papierrollenhalter und Bürstengarnitur
Стойка: бумагодержатель + ёрш металлический
base cm 16 L x 17 P x 68,5 H

• 08 € 275,00



Q 21

Piantana: scopino, porta sapone, porta asciugamani e porta rotolo
Free-standing upright: toilet brush holder, soap dish, towel holder and paper holder
Montant autonome: porte balayent, porte savon, porte serviette et porte rouleau
Ständer: Bürstengarnitur, Seifenschale, Handtuchhalter und Papierrollenhalter
Стойка: ёрш металлический + мыльница + бумагодержатель + полотенецдержатель
base cm 16 L x 14 P x 93,5 H

• 08 € 400,00

* Con dosatore sapone liquido (maggiorazione)
With liquid soap dispenser (supplement)
Avec doseur de savon liquid (supplément)
Mit Seifenspender (Zuschlag)
с дозатором (дополнительно)

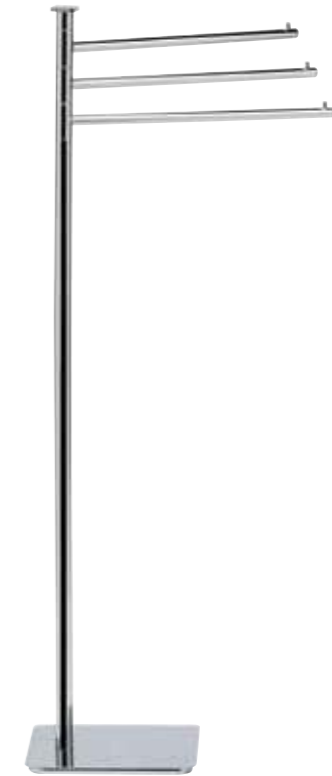

Q 19

Piantana con 3 portasciugamani
Free-standing upright with 3 towel holders
Montant autonome avec 3 porte serviette
Handtuchständer 3 armig
Стойка: 3 полотенецдержателя
base cm 20 L x 15 P x 86 H - 30,5 L

• 08 € 300,00



Q 817

Piantana porta accappatoio con 3 portasciugamani
Free-standing upright bathrobe with 3 towel holders
Montant autonome peignoir avec 3 porte serviette
Bademantelständer 3 armig
Стойка для халата и под 3 полотенца
base cm 22 L x 22 P x 173,5 H - 30 L

• 08 € 420,00

QUID

realizzata in ottone / realized in brass / réalisée en laiton / aus Messing hergestellt / Сделано из латуни

Designer Claudio Papa





ELITE

realizzata in ottone / realized in brass / réalisée en laiton / aus Messing hergestellt / Сделано из латуни



EL 20

Piantana: porta rotolo e scopino
Free-standing upright: paper holder
and toilet-brush holder
Montant autonome: porte rouleau et porte balayent
Ständer: Papierrollenhalter und Bürstengarnitur
Стойка: бумагодержатель +
ерш металлический
base cm Ø 20 x 67 H

• 08	€ 295,00
• 16 - 25 - 36	€ 380,00
• FN	€ 440,00



EL 21

Piantana: scopino, porta sapone,
porta asciugamani e porta rotolo
Free-standing upright: toilet brush holder,
soap dish, towel holder and paper holder
Montant autonome: porte balayent, porte
savon, porte serviette et porte rouleau
Ständer: Bürstengarnitur, Seifenschale,
Handtuchhalter und Papierrollenhalter
Стойка: ёрш металлический +
мыльница + бумагодержатель +
полотенцедержатель
base cm Ø 20 x 85,5 H

• 08	€ 380,00
• 16 - 25 - 36	€ 495,00
• FN	€ 570,00

* Con dosatore sapone liquido (maggiorazione) € 35,00
With liquid soap dispenser (supplement)
Avec doseur de savon liquid (supplément)
Mit Seifenspender (Zuschlag)
с дозатором (дополнительно)

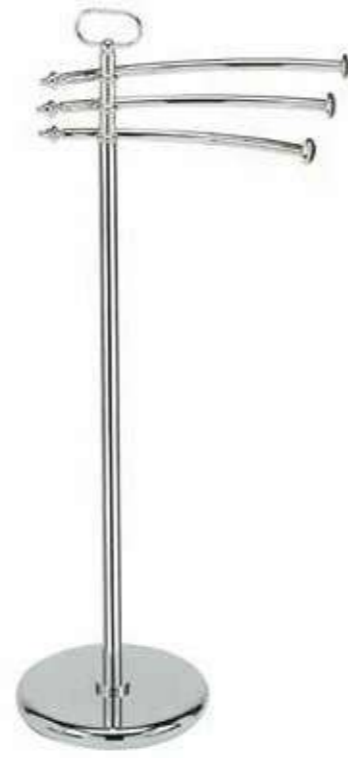

EL 19

Piantana con 3 portasciugamani
Free-standing upright with 3 towel holders
Montant autonome avec 3 porte serviette
Handtuchständer 3 armig
Стойка: 3 полотенецдержателя
base cm Ø 25 x 91 H - 30/27/24 L

• 08	€ 350,00
• 16 - 25 - 36	€ 450,00
• FN	€ 530,00



746 NESTOR

Portasciugamani
Free-standing towel holder
Montant autonome porte serviette
Handtuchständer
полотенцедержатель напольный
cm 58 L x 35 P x 80 H

• 08	€ 495,00
• 16 - 25 - 36	€ 620,00
• FN	€ 740,00



741 MIRTA

Piantana porta accappatoio
con 3 portasciugamani
Free-standing upright bathrobe with 3 towel holders
Montant autonome peignoir avec 3 porte serviette
Bademantelständer 3 armig
Стойка: 3 крючка под халаты и 3
полотенецдержателя
base cm Ø 25 x 168 H - 32 L

• 08	€ 410,00
• 16 - 25 - 36	€ 510,00
• FN	€ 620,00

** FINITURA DISPONIBILE IN 20 GG.
Finish available in 20 days
Finition disponible en 20 jours
Oberfläche lieferbar in 20 Tagen
Отделка доступна в течение 20 дней



02

16**



25

36**





NEMI

realizzata in ottone / realized in brass / réalisée en laiton / aus Messing hergestellt / Сделано из латуни



33

40

N 20

Piantana: porta rotolo e scopino
Free-standing upright: paper holder
and toilet-brush holder
Montant autonome: porte rouleau et porte
balayent
Ständer: Papierrollenhalter und Bürstengarnitur
Стойка: бумагодержатель +
ёрш металлический
base cm Ø 20 x 69 H

• 33 - 39	€ 295,00
• 40	€ 320,00

N 21

Piantana: scopino, porta sapone, porta
asciugamani e porta rotolo
Free-standing upright: toilet brush holder,
soap dish, towel holder and paper holder
Montant autonome: porte balayent,
porte savon, porte serviette et porte rouleau
Ständer: Bürstengarnitur, Seifenschale,
Handtuchhalter und Papierrollenhalter
Стойка: ёрш металлический +
мыльница + бумагодержатель +
полотенцедержатель
base cm Ø 20 x 79 H

• 33 - 39	€ 370,00
• 40	€ 400,00

N 19

Piantana con 3 portasciugamani
Free-standing upright with 3 towel holders
Montant autonome avec 3 porte serviette
Handtuchständer 3 armig
Стойка: 3 полотенцедержателя
base cm Ø 25 x 91 H - 32 L

• 33 - 39	€ 285,00
• 40	€ 300,00

N 23

Piantana porta accappatoio
con 3 portasciugamani
Free-standing upright bathrobe with 3 towel holders
Montant autonome peignoir avec 3 porte serviette
Bademantelständer 3 armig
Стойка: 3 крючка под халаты и 3
полотенцедержателя
base cm Ø 25 x 169 H

• 33 - 39	€ 420,00
• 40	€ 430,00

GIUNONE

realizzata in ottone / realized in brass / réalisée en laiton / aus Messing hergestellt / Сделано из латуни

** FINITURA DISPONIBILE IN 20 GG.
 ** Finish available in 20 days
 Finition disponible en 20 jours
 Oberfläche lieferbar in 20 Tagen
 Отделка доступна в течение 20 дней



02

16**



25

G 691

Piantana: porta rotolo e scopino
 Free-standing upright: paper holder
 and toilet-brush holder
 Montant autonome: porte rouleau et porte balayent
 Ständer: Papierrollenhalter und Bürstengarnitur
 Стойка: бумагодержатель + ерш металлический
 base cm Ø 20 x 67 H

• 08	€ 310,00
• 02 - 03 - 04	€ 340,00
• 16 - 25 - 26 - 36	€ 390,00

G 697

Piantana: scopino, porta sapone,
 porta asciugamani e porta rotolo
 Free-standing upright: toilet brush, soap dish,
 towel holder and paper holder
 Montant autonome: balayent, porte savon,
 porte serviette et porte rouleau
 Ständer: Bürstengarnitur, Seifenschale,
 Handtuchhalter und Papierrollenhalter
 Стойка: ёрш металлический +
 мьльница + бумагодержатель +
 полотенцедержатель
 base cm Ø 20 x 85 H

• 08	€ 410,00
• 02 - 03 - 04	€ 450,00
• 16 - 25 - 26 - 36	€ 520,00

G 696

Piantana con 3 portasciugamani
 Free-standing upright with 3 towel holders
 Montant autonome avec 3 porte serviette
 Handtuchständer 3 armig
 Стойка для 3-х полотенец
 base cm Ø 25 x 98 H - 25/28/31 L

• 08	€ 430,00
• 02 - 03 - 04	€ 470,00
• 16 - 25 - 26 - 36	€ 540,00

PR 20

Piantana: porta rotolo e scopino
 Free-standing upright: paper holder
 and toilet-brush holder
 Montant autonome: porte rouleau et porte balayent
 Ständer: Papierrollenhalter und Bürstengarnitur
 Стойка: бумагодержатель +
 ерш металлический
 base cm Ø 20 x 73 H

• 08	€ 360,00
• 16 - 25	€ 460,00

PR 21

Piantana: scopino, porta sapone,
 porta asciugamani e porta rotolo
 Free-standing upright: toilet brush holder,
 soap dish, towel holder and paper holder
 Montant autonome: porte balayent, porte
 savon, porte serviette et porte rouleau
 Ständer: Bürstengarnitur, Seifenschale,
 Handtuchhalter und Papierrollenhalter
 Стойка: ёрш металлический +
 мьльница + бумагодержатель +
 полотенцедержатель
 base cm Ø 20 x 90 H

• 08	€ 460,00
• 16 - 25	€ 595,00
• Con dosatore sapone liquido (maggiorazione) With liquid soap dispenser (supplement) Avec doseur de savon liquid (supplément) Mit Seifenspender (Zuschlag) с дозатором (дополнительно)	€ 45,00

*
 *
 *
 с дозатором (дополнительно)

PR 19

Piantana con 3 portasciugamani
 Free-standing upright with 3 towel holders
 Montant autonome avec 3 porte serviette
 Handtuchständer 3 armig
 Стойка: 3 полотенцедержателя
 base cm Ø 25 x 93 H - 30/27/24 L

• 08	€ 400,00
• 16 - 25	€ 500,00



*

** FINITURA DISPONIBILE IN 20 GG.
 ** Finish available in 20 days
 Finition disponible en 20 jours
 Oberfläche lieferbar in 20 Tagen
 Отделка доступна в течение 20 дней



16**

25**

URANIA

realizzata in ottone / realized in brass / réalisée en laiton / aus Messing hergestellt / Сделано из латуни



U 24 URANIA

Colonna componibile a parete per lavabo
Wall mounted modular column for washbasin
Colonne à éléments à mur pour lavabo
Stangensystem für Waschtisch-Set
Настенная модульная колонна в комплектации для раковины

U 24 ASTA H cm 90 Bar cm 90 H / Barre H cm 90 / Stange H cm 90	€ 185,00
U 24.561 SPECCHIO INGRANDITORE CM. 12 Enlarging mirror / Miroir agrandisseur / Vergrößerungsspiegel	€ 105,00
U 24.05 ASTA PORTASCIUGAMANI CM. 35 L Towel holder / Porte serviette / Handtuchhalter	€ 52,00
U 24.09 PORTA SAPONE Soap dish / Porte savon / Seifenschale	€ 82,00
U 24.10 PORTA BICCHIERE Glass holder / Porte verre / Zahnbürstenhalter	€ 82,00
COMPOSIZIONE COME FOTO Composition as photo Composition comme photo Kombination wie auf dem Bild Композиция как фото	€ 558,00



U 25 URANIA

Colonna componibile a parete per wc/bidet
Wall mounted modular column for wc/bidet
Colonne à éléments à mur pour wc/bidet
Stangensystem für WC/Bidet-Set
Настенная модульная колонна в комплектации для унитаза/биде

U 25 ASTA H cm 70 Bar cm 70 H / Barre H cm 70 / Stange H cm 70	€ 178,00
U 25.06 ASTA PORTASCIUGAMANI CM. 25 L Towel holder / Porte serviette / Handtuchhalter	€ 47,00
U 25.30 DOSATORE SAPONE LIQUIDO Dispenser liquid soap / Doseur de savon liquid / Seifenspender	€ 132,00
U 25.11 PORTA ROTOLO Paper holder / Porte rouleau / Papierrollenhalter	€ 44,00
U 25.039 PORTA SCOPINO QUADRO Square toilet brush / Porte balaynet cadre / Quadratische Bürstengarnitur	€ 185,00
COMPOSIZIONE COME FOTO CM 75 Composition as photo Composition comme photo Kombination wie auf dem Bild Композиция как фото	€ 586,00



U 26

Colonna componibile a parete porta salviette
Modular wall-mounted towel rail column
Colonne porte-serviettes murale modulaire
Modulare wandmontierte Handtuchhalter-Säule
Модульная настенная колонна для полотенцесушителя
cm 35L x 40H

• 08	€ 290,00
------	----------



ME 24

Colonna componibile a parete per lavabo
Wall mounted modular column for washbasin
Colonne à éléments à mur pour lavabo
Stangensystem für Waschtisch-Set
Настенная модульная колонна в комплектации для раковины

ME 24 ASTA H cm 80 Bar cm 80 H / Barre H cm 80 / Stange H cm 80	€ 130,00
ME 24.05 ASTA PORTASCIUGAMANI CM. 35 L Towel holder / Porte serviette / Handtuchhalter	€ 52,00
ME 24.09V PORTA SAPONE IN VETRO Glass soap dish / Porte savon en verre / Seifenschale aus Glas	€ 83,00
ME 24.10V PORTA BICCHIERE IN VETRO Glass holder / Porte verre / Zahnbürstenhalter	€ 62,00
ME 24.10M PORTA BICCHIERE IN METALLO Metal glass holder / Porte verre en métal / Zahnbürstenhalter aus Metall	€ 94,00
ME 24.562 SPECCHIO INGRANDITORE Enlarging mirror / Miroir agrandisseur / Vergrößerungsspiegel	€ 107,00
COMPOSIZIONE COME FOTO Composition as photo Composition comme photo Kombination wie auf dem Bild Композиция как фото	€ 411,00

MEDEA

realizzata in ottone / realized in brass / réalisée en laiton / aus Messing hergestellt / Сделано из латуни



ME 25

Colonna componibile a parete per wc/bidet
Wall mounted modular column for wc/bidet
Colonne à éléments à mur pour wc/bidet
Stangensystem für WC/Bidet-Set
Настенная модульная колонна в комплектации для унитаза/биде

ME 25 ASTA H cm 70 Bar cm 70 H / Barre H cm 70 / Stange H cm 70	€ 126,00
ME 25.06 ASTA PORTASCIUGAMANI CM. 25 L Towel holder / Porte serviette / Handtuchhalter	€ 46,00
ME 25.30 DOSATORE SAPONE LIQUIDO Dispenser liquid soap / Doseur de savon liquid / Seifenspender	€ 100,00
ME 25.11 PORTA ROTOLO Paper holder / Porte rouleau / Papierrollenhalter	€ 40,00
ME 25.039 PORTA SCOPINO IN OTTONE Brass toilet brush / Porte balaynet en laiton / Bürstengarnitur aus Messing	€ 103,00
COMPOSIZIONE COME FOTO CM 75 Composition as photo Composition comme photo Kombination wie auf dem Bild Композиция как фото	€ 415,00



ME 26

Colonna componibile a parete porta salviette
Modular wall-mounted towel rail column
Colonne porte-serviettes murale modulaire
Modulare wandmontierte Handtuchhalter-Säule
Модульная настенная колонна для полотенцесушителя
cm 35L x 40H

• 08	€ 260,00
------	----------



OGGETTISTICA

Designer: STILHAUS, BGR, PAPA, SETTIMELLI, TALOCCI, PALLOCCA



ECO

colori disponibili / available colours / couleurs disponibles / verfügbare Farben



BIANCO
white
blanc
weiß
белый



VERDE
green
vert
grün
зеленый



ROSSO
red
rouge
rot
красный



NERO
black
noir
schwarz
черный



MARRONE
brown
brun
braun
коричневый



GRIGIO
grey
gris
gray
серый

ECO [design Gianluca Paludi]

1160

Porta spazzolini, diffusore musicale in ceramica
Ceramic toothbrush holder and music speaker
Porte brosses et haut-parleur musical en
ceramique

Zahnburstenhalter mit Musik-Lautsprecher
aus Keramik

дозатор керамический + подставка для
зубных щёток

cm 14 L x 18 P x 16 H

- Bianco / white / blanc / weiß € 85,00
- Colorato / colored / coloré / farbig € 95,00



Guarda il video sul nostro canale youtube
Watch the video on our youtube channel
Regardez la vidéo sur notre chaîne Youtube
Sehen Sie sich das Video auf unserem Youtube-Kanal an
Смотрите видео на нашем канале youtube



ECO: Modello registrato EU N. 004544708-0001
ECO: European Patent No. 004544708-0001
ECO: Brevet Européen No. 004544708-0001
ECO: Europäisches Patent Nr. 004544708-0001
ECO: Europäisches патент 004544708-0001

OGGETTISTICA DIFFUSORE PROFUMO

RETTANGOLO

Serie in Neolite
Neolite series
Série Neolite
Neolith-Reihe
серия неолитов

1265

Diffusore di profumo con bacchette
Perfume diffuser with wands
Diffuseur de parfum avec baguettes
Parfümzerstäuber mit Stäben
Парфюмерный диффузор с палочками
cm 10,5 L x 7 P x 14 H

• BI / 08 - 23	€ 115,00
• BI / 16 - 17 - 18 - 36	€ 140,00
• NE / 08 - 23	€ 130,00
• NE / 16 - 17 - 18 - 36	€ 160,00



OGGETTISTICA DIFFUSORE PROFUMO

DIVA

Serie in ceramica bianca
White ceramic set
Série en céramique blanc
Serie aus weißer Keramik
серия в белой керамике

1267

Diffusore di profumo con bacchette
Perfume diffuser with wands
Diffuseur de parfum avec baguettes
Parfümzerstäuber mit Stäben
Парфюмерный диффузор с палочками
cm 7 L x 7 P x 20 H

• 08 - 23	€ 60,00
• 17 - 18 - 36	€ 75,00

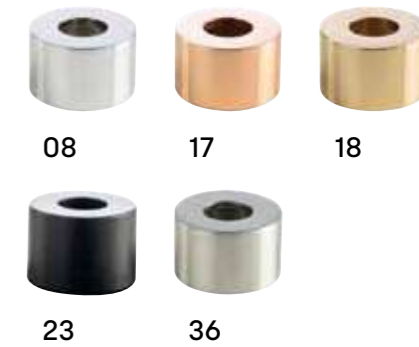

LIVING

Serie in ceramica bianca
White ceramic set
Série en céramique blanc
Serie aus weißer Keramik
серия в белой керамике

1266

Diffusore di profumo con bacchette
Perfume diffuser with wands
Diffuseur de parfum avec baguettes
Parfümzerstäuber mit Stäben
Парфюмерный диффузор с палочками
cm 6 L x 9 P x 20 H

• 08 - 23	€ 60,00
• 17 - 18 - 36	€ 75,00



CRISTALLO

Serie in cristallo
Crystal set
Série en cristal
Serie aus Kristallglas
Серия из стекла

1268

Diffusore di profumo con bacchette
Perfume diffuser with wands
Diffuseur de parfum avec baguettes
Parfümzerstäuber mit Stäben
Парфюмерный диффузор с палочками
cm Ø 7,5 x 14 H

• 08	€ 250,00
• 17 - 18 - 36 - 25	€ 280,00





RETTANGOLO
[design Massimiliano Settimesti]

Serie in Neolite
Neolite series
Série Neolite
Neolith-Reihe
серия НЕОЛИТОВ

1201

Porta sapone
Soap dish/Porte savon/Seifenschale/
Настольная мыльница
cm 13 L x 9 P x 3 H

• BI	€ 65,00
• NE	€ 75,00

1202

Bicchieri
Glass/Verre/Zahnputzbecher/Настольный стакан
cm 10,5 L x 7 P x 10 H

• BI	€ 74,00
• NE	€ 94,00

1203

Dosatore sapone
Liquid soap dispenser/Seifenspender/
Dose mit Deckel /настойный дозатор
cm 10,5 L x 7 P x 14 H

• BI / 08 - 23	€ 135,00
• BI / 16 - 18 - 36	€ 165,00
• NE / 08 - 23	€ 150,00
• NE / 16 - 18 - 36	€ 175,00



BI 08



BI 18



BI 36



BI 23



BI 16



NE 08



NE 18



NE 36



NE 23



NE 16



BI 08



BI 18



BI 36



BI 23



BI 16



NE 08



NE 18



NE 36



NE 23



NE 16

TONDO

[design Massimiliano Settimelli]

Serie in Neolite
Neolite series
Série Neolite
Neolith-Reihe
серия НЕОЛИТОВ

1204

Porta sapone
Soap dish/Porte savon/Seifenschale/
Настольная мыльница
cm Ø 12 x 3 H

• BI	€ 65,00
• NE	€ 75,00

1205

Bicchieri
Glass/Verre/Zahnputzbecher/Настольный стакан
cm Ø 7,5 x 13 H

• BI	€ 75,00
• NE	€ 85,00

1206

Dosatore sapone
Liquid soap dispenser/Seifenspender/
Dose mit Deckel /настойный дозатор
cm Ø 7,5 x 17 H

• BI / 08 - 23	€ 135,00
• BI / 16 - 18 - 36	€ 165,00
• NE / 08 - 23	€ 150,00
• NE / 16 - 18 - 36	€ 175,00



BI 08



BI 36



BI 23



BI 16



NE 08



NE 36



NE 23



NE 16

RAIL
[design Giovanna Talocci e Marco Pallocca]

Serie in Neolite
Neolite series
Série Neolite
Neolith-Reihe
серия НЕОЛИТОВ

1350

Porta sapone
Soap dish/Porte savon/Seifenschale/
Настольная мыльница
cm 10,5 L x 10,5 P x 3 H

• BI	€ 65,00
• NE	€ 75,00

1351

Bicchieri
Glass/Verre/Zahnputzbecher/Настольный стакан
cm 7 L x 7 P x 11 H

• BI	€ 74,00
• NE	€ 94,00

1352

Dosatore sapone
Liquid soap dispenser/Seifenspender/
Dose mit Deckel /настольный дозатор
cm 7 L x 7 P x 15 H

• BI / 08 - 23	€ 135,00
• BI / 16 - 18 - 36	€ 165,00
• NE / 08 - 23	€ 150,00
• NE / 16 - 18 - 36	€ 175,00

EQUILIBRIUM DISEGNI

Serie in ottone cromato
 Chromed brass set
 Série en laiton chromée
 Serie aus verchromtem Messing
 Серия в хроме

EQDA 30 AP

Dosatore sapone **DIAMANTE**
 Liquid soap dispenser / Porte savon liquid /
 Seifenspender / дозатор
 cm Ø 6 x 17 H

• 08 - 23 - 24	€ 120,00
• FN	€ 165,00

EQDB 30 AP

Dosatore sapone **GESSATO**
 Liquid soap dispenser / Porte savon liquid /
 Seifenspender / дозатор
 cm Ø 6 x 17 H

• 08 - 23 - 24	€ 120,00
• FN	€ 165,00

EQDC 30 AP

Dosatore sapone **RIGATO**
 Liquid soap dispenser / Porte savon liquid /
 Seifenspender / дозатор
 cm Ø 6 x 17 H

• 08 - 23 - 24	€ 170,00
• FN	€ 230,00

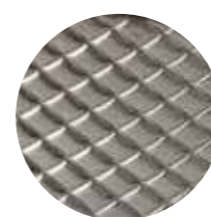

A - DIAMANTE/DIAMOND

B - GESSATO/PINSTRIFE

C - RIGATO/STRIPE



EQUILIBRIUM DISEGNI

[design Gianluca Paludi]

Serie in ottone cromato
 Chromed brass set
 Série en laiton chromée
 Serie aus verchromtem Messing
 Серия в хроме

EQDA 10 AP

Bicchiere **DIAMANTE**
 Glass / Verre / Zahnputzbecher / стакан
 cm Ø 6 x 11 H

• 08 - 23 - 24	€ 85,00
• FN	€ 120,00

EQDB 10 AP

Bicchiere **GESSATO**
 Glass / Verre / Zahnputzbecher / стакан
 cm Ø 6 x 11 H

• 08 - 23 - 24	€ 85,00
• FN	€ 120,00

EQDC 10 AP

Bicchiere **RIGATO**
 Glass / Verre / Zahnputzbecher / стакан
 cm Ø 6 x 11 H

• 08 - 23 - 24	€ 135,00
• FN	€ 190,00

OGGETTISTICA

MEDEA

Serie in ottone cromato
Chromed brass set
Série en laiton chromée
Serie aus verchromtem Messing
Серия в хроме



* FINITURA DISPONIBILE IN 20 GG.
Finish available in 20 days
Finition disponible en 20 jours
Oberfläche lieferbar in 20 Tagen
Отделка доступна в течение 20 дней

ME 09 M AP

Porta sapone
Soap dish / Porte savon / Seifenschale /
мыльница
cm Ø 12 x 11 H

• 08	€ 49,00
• 18 - 23 - 24 - 36 - 16	€ 70,00
• FN	€ 80,00

ME 10 AP

Bicchiere
Glass / Verre / Zahnputzbecher / стакан
cm Ø 6 x 11 H

• 08 - 23 - 24	€ 50,00
• 18 - 36 - 16	€ 84,00
• FN	€ 95,00

ME 30 AP

Dosatore sapone con pompetta in metallo
Liquid soap dispenser / Porte savon liquid /
Seifenspender / Настольный дозатор
cm Ø 6 x 16 H

• 08 - 23 - 24	€ 90,00
• 18 - 36 - 16	€ 135,00
• FN	€ 155,00



URANIA

Serie in ottone cromato
Chromed brass set
Série en laiton chromée
Serie aus verchromtem Messing
серия из металла

981

Porta sapone
Soap dish / Porte savon / Seifenschale /
мыльница
cm 10 L x 10 P x 1 H

• 08	€ 46,00
------	---------

982

Bicchiere
Glass / Verre / Zahnputzbecher / стакан
cm 6 L x 6 P x 11 H

• 08	€ 74,00
------	---------

983

Dosatore sapone con pompetta in metallo
Liquid soap dispenser / Porte savon liquid /
Seifenspender / дозатор
cm 6 L x 6 P x 17 H

• 08	€ 120,00
------	----------



OGGETTISTICA

DIANA

Serie in ottone cromato ovale
Oval chromed brass set
Série en laiton chromée ovale
Serie aus verchromtem Messing oval
серия из металла

917

Porta sapone ovale
Oval soap dish / Porte savon ovale /
Seifenschale oval / овальная мыльница
cm 14 L x 8,5 P x 2 H

• 08	€ 46,00
------	---------

918

Bicchiere ovale
Oval glass / Verre ovale / Zahnputzbecher oval
/ овальный стакан
cm 5,5 L x 8 P x 11 H

• 08	€ 74,00
------	---------

919

Dosatore sapone con pompetta in metallo
Liquid soap dispenser / Porte savon liquid /
Seifenspender / дозатор
cm 5,5 L x 8 P x 16 H

• 08	€ 110,00
------	----------



REGAL

Serie in ottone cromato
Chromed brass set
Série en laiton chromée
Serie aus verchromtem Messing
Серия в хроме

ME 09M AP

Porta sapone
Soap dish / Porte savon / Seifenschale /
мыльница
cm Ø 12 x 2,5 H

• 08	€ 49,00
• 16	€ 70,00

1130

Bicchiere
Glass / Verre / Zahnputzbecher / стакан
cm Ø 6 x 11 H

• 08	€ 69,00
• 16	€ 99,00

1131

Dosatore sapone con pompetta in metallo
Liquid soap dispenser / Porte savon liquid /
Seifenspender / Настольный дозатор
cm Ø 6 x 16 H

• 08	€ 110,00
• 16	€ 165,00



QUEEN TRASPARENTE

Serie in cristallo
Crystal set
Série en cristal
Serie aus Kristallglas
Серия из стекла



1271 TR

Dosatore sapone
Liquid soap dispenser / Seifenspender /
Dose mit Deckel / настольный дозатор
cm Ø 7,5 x 17 H

• 08	€ 310,00
• 16 - 18 - 36	€ 360,00

1270 TR

Bicchiere
Glass/Verre/Zahnputzbecher/Настольный стакан
cm Ø 7,5 x 12 H

• vetro / glass / verre / Glas	€ 195,00
--------------------------------	----------

1269 TR

Porta sapone
Soap dish / Porte savon / Seifenschale /
Настольная мыльница
cm Ø 10 x 4 H

• vetro / glass / verre / Glas	€ 125,00
--------------------------------	----------

1268 TR

Diffusore di profumo con bacchette
Perfume diffuser with wands
Diffuseur de parfum avec baguettes
Parfümzerstäuber mit Stäben
Парфюмерный диффузор с палочками
cm Ø 7,5 x 14 H

• 08	€ 250,00
• 16 - 18 - 36	€ 280,00

1272 TR

Contentitore porta kleenex
Kleenex container
Boîte à Kleenex
Kleenex-Behälter
Контейнер для клинекса
cm 13 L x 13 P x 13H

• vetro / glass / verre / Glas	€ 340,00
--------------------------------	----------

QUEEN AMBRA

Serie in cristallo
Crystal set
Série en cristal
Serie aus Kristallglas
Серия из стекла



1271 AM

Dosatore sapone
Liquid soap dispenser / Seifenspender /
Dose mit Deckel / настольный дозатор
cm Ø 7,5 x 17 H

• 08	€ 310,00
• 16 - 18 - 36	€ 360,00

1270 AM

Bicchiere
Glass/Verre/Zahnputzbecher/Настольный стакан
cm Ø 7,5 x 12 H

• vetro / glass / verre / Glas	€ 220,00
--------------------------------	----------

1269 AM

Porta sapone
Soap dish / Porte savon / Seifenschale /
Настольная мыльница
cm Ø 10 x 4 H

• vetro / glass / verre / Glas	€ 140,00
--------------------------------	----------

1268 AM

Diffusore di profumo con bacchette
Perfume diffuser with wands
Diffuseur de parfum avec baguettes
Parfümzerstäuber mit Stäben
Парфюмерный диффузор с палочками
cm Ø 7,5 x 14 H

• 08	€ 280,00
• 16 - 18 - 36	€ 330,00

1272 AM

Contentitore porta kleenex
Kleenex container
Boîte à Kleenex
Kleenex-Behälter
Контейнер для клинекса
cm 13 L x 13 P x 13H

• vetro / glass / verre / Glas	€ 395,00
--------------------------------	----------

EQUILIBRIUM MARMO

Serie in marmo
Marble set
Série en marbre
Serie aus Marmor
Мрамор

EQM 10 AP

Bicchieri in Marmo
Marble glass
Verre marbré
Marmoriertes Glas
Мраморное стекло
cm - Ø 7,5 x 13 H

• € 240,00

EQM 30 AP

Dosatore sapone liquido in Marmo
Marble liquid soap dispenser
Distributeur de savon liquide en marbre
Flüssigseifenspender aus Marmor
Мраморный дозатор для жидкого мыла
cm - Ø 7,5 x 17 H

• 08-23 € 310,00
• 18-36 € 345,00
• 17 € 365,00



CRACLÈ

Serie in cristallo
Crystal set
Série en cristal
Serie aus Kristallglas
Серия из стекла

1124

Porta sapone
Soap dish/Porte savon/Seifenschale/
Настольная мыльница
cm Ø 13 x 3 H

• TR € 55,00
• AM-AZ € 60,00

1125

Bicchieri
Glass/Verre/Zahnputzbecher/Настольный стакан
cm Ø 8 x 9 H

• TR € 58,00
• AM-AZ € 68,00

1126

Dosatore sapone
Liquid soap dispenser/Seifenspender/
Dose mit Deckel /настойный дозатор
cm Ø 8 x 18 H

• TR € 89,00
• AM-AZ € 100,00



SARA

Serie in vetro bianco o colorato
White or coloured glass set
Série en verre blanc ou colorée
Serie aus weißem oder farbigem Glas
серия из белого или цветного стекла

579

Porta sapone
Soap dish / Porte savon / Seifenschale
/мыльница
cm Ø 12 x 2 H

• 01 € 19,00
• vetro colorato / colored glass / verre coloré € 28,00
farbiges Glas / витражи

578

Bicchieri
Glass / Verre / Zahnputzbecher / стакан
cm Ø 7 x 9 H

• 01 € 22,00
• vetro colorato / colored glass / verre coloré € 30,00
farbiges Glas / витражи

580

Dosatore sapone con pompetta in metallo
Liquid soap dispenser / Porte savon liquid /
Seifenspender / дозатор
cm Ø 9 x 18 H

• 01 € 42,00
• vetro colorato / colored glass / verre coloré € 52,00
farbiges Glas / витражи

DIVA [design Massimiliano Settimelli]

Serie in ceramica bianca
White ceramic set
Série en céramique blanc
Serie aus weißer Keramik
серия в белой керамике

DV 09 AP

Porta sapone
Soap dish / Porte savon / Seifenschale /
мыльница
cm 8 L x 12 P x 2 H

• Bianco / white / blanc / weiß € 24,00

DV 10 AP

Bicchieri
Glass / Verre / Zahnputzbecher / стакан
cm 7 L x 7 P x 14,5 H

• Bianco / white / blanc / weiß € 29,00

DV 30 AP

Dosatore sapone con pompetta in metallo
Liquid soap dispenser / Porte savon liquid /
Seifenspender / дозатор
cm 7 L x 7 P x 21 H

• Bianco / white / blanc / weiß € 56,00

DV 14 AP

Porta oggetti
Stowage try / Plateau / Tablett / лоток
cm 20 L x 10 P x 2 H

• Bianco / white / blanc / weiß € 29,00

LIVING [design BGR]

Serie in ceramica bianca
White ceramic set
Série en céramique blanc
Serie aus weißer Keramik
серия в белой керамике

LV 09 AP

Porta sapone
Soap dish / Porte savon / Seifenschale /
мыльница
cm 8 L x 12 P x 2 H

• Bianco / white / blanc / weiß € 22,00

LV 10 AP

Bicchieri
Glass / Verre / Zahnputzbecher / стакан
cm 6 L x 9 P x 14,5 H

• Bianco / white / blanc / weiß € 26,00

LV 30 AP

Dosatore sapone con pompetta in metallo
Liquid soap dispenser / Porte savon liquid /
Seifenspender / дозатор
cm 6 L x 9 P x 21 H

• Bianco / white / blanc / weiß € 75,00

• A Bianco / A white / A blanc / A weiß € 58,00



CUBE

Serie in ceramica con base ottone cromato
Ceramic set with chromed brass base
Série en céramique avec base en laiton chromée
Serie aus Keramik mit Fuß aus verchromtem Messing
серия из керамики на металлической ножке

616

Porta sapone
Soap dish / Porte savon / Seifenschale /
мыльница
cm 10 L x 10 P x 5 H

• 08 € 75,00

617

Bicchieri
Glass / Verre / Zahnputzbecher / стакан
cm 9 L x 9 P x 12 H

• 08 € 75,00

618

Dosatore sapone con pompetta in metallo
Liquid soap dispenser / Porte savon liquid /
Seifenspender / дозатор
cm 10 L x 7 P x 19 H

• 08 € 125,00



OPERA

Serie in ceramica con base ottone cromato
Ceramic set with chromed brass base
Série en céramique avec base en laiton chromée
Serie aus Keramik mit Fuß aus verchromtem Messing
серия из керамики на металлической ножке

OP 09 AP

Porta sapone
Soap dish / Porte savon / Seifenschale /
мыльница
cm Ø 12 x 5 H

• 08 € 72,00

• 16 € 89,00

• 17 € 105,00

OP 10 AP

Bicchieri
Glass / Verre / Zahnputzbecher / стакан
cm Ø 10 x 12 H

• 08 € 72,00

• 16 € 89,00

• 17 € 105,00

OP 30 AP

Dosatore sapone con pompetta in metallo
Liquid soap dispenser / Porte savon liquid /
Seifenspender / дозатор
cm Ø 10 x 21 H

• 08 € 99,00

• 16 € 120,00

• 17 € 155,00

ZEFIRO [design Claudio Papa]

Serie in ceramica
Ceramic set
Série en céramique
Serie aus Keramik
серия из керамики

652

Porta sapone
Soap dish / Porte savon / Seifenschale /
настольная мыльница
cm 13 L x 8 P x 2 H

- Bianco / white / blanc / weiß € 21,00
- Colorato / colored / coloré / farbig € 23,00

653

Bicchiere
Glass / Verre / Zahnputzbecher /
настольный стакан
cm 13 L x 7 P x 10 H

- Bianco / white / blanc / weiß € 27,00
- Colorato / colored / coloré / farbig € 29,00

654

Dosatore sapone con pompetta in metallo
Liquid soap dispenser / Porte savon liquid /
Seifenspender / настольный дозатор
cm 10 L x 7 P x 19 H

- Bianco / white / blanc / weiß € 59,00
- Colorato / colored / coloré / farbig € 63,00

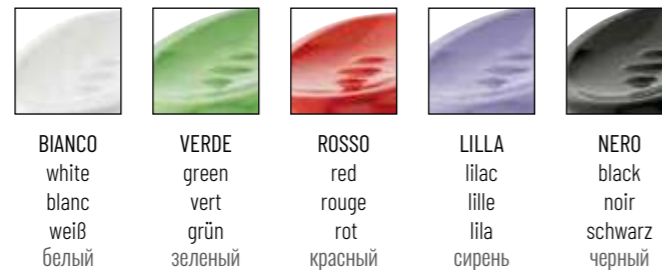

LIZ [design Massimiliano Settimelli]

Serie in ceramica
Ceramic set
Série en céramique
Serie aus Keramik
серия из керамики

LZ 09 AP

Porta sapone
Soap dish / Porte savon / Seifenschale /
мыльница
cm 13 L x 9 P x 2,5 H

- 08 € 23,00

LZ 10 AP

Bicchiere
Glass / Verre / Zahnputzbecher / стакан
cm Ø 8 x 11,5 H

- 08 € 24,00

LZ 30 AP

Dosatore sapone con pompetta in metallo
Liquid soap dispenser / Porte savon liquid /
Seifenspender / дозатор
cm Ø 8 x 17 H

- 08 € 58,00



FAUL

Serie in ceramica bianca o colorata
White or coloured ceramic set
Série en céramique blanc ou colorée
Serie aus weißer oder farbiger Keramik
Серия с белой или цветной керамикой

794

Porta sapone
Soap dish / Porte savon / Seifenschale /
мыльница
cm 10 L x 10 P x 2 H

- Bianco / white / blanc / weiß € 21,00
- Colorato / colored / coloré / farbig € 28,00

793

Bicchiere
Glass / Verre / Zahnputzbecher / стакан
cm 13 L x 7 P x 10 H

- Bianco / white / blanc / weiß € 25,00
- Colorato / colored / coloré / farbig € 30,00

795

Dosatore sapone con pompetta in metallo
Liquid soap dispenser / Porte savon liquid /
Seifenspender / дозатор
cm 7,5 L x 7,5 P x 10 H

- Bianco / white / blanc / weiß € 72,00
- Colorato / colored / coloré / farbig € 83,00
- 16 - Oro (maggiorazione)
(supplément)
(supplément)
(Zuschlag) € 10,00



BUCKET

Serie in ceramica
Ceramic set
Série en céramique
Serie aus Keramik
серия из керамики

BK 09 AP

Porta sapone
Soap dish / Porte savon / Seifenschale /
мыльница
cm Ø 12 x 3,5 H

- 01 € 21,00

BK 10 AP

Bicchiere
Glass / Verre / Zahnputzbecher / стакан
cm Ø 9 x 10 H

- 01 € 21,00

BK 30 AP

Dosatore sapone con pompetta in metallo
Liquid soap dispenser / Porte savon liquid /
Seifenspender / дозатор
cm Ø 9 x 18 H

- 01 € 55,00



MARTE

Serie in vetro con base in ottone
Glass set with brass base
Série en verre avec base en laiton
Serie mit Fuß aus Messing
серия в стекле на металлической ножке

MA 09 AP

Porta sapone
Soap dish / Porte savon / Seifenschale /
мыльница
cm 15 L x 14 P x 12 H

• 08	€ 89,00
• 16 - 25 - 36	€ 115,00

MA 10 AP

Bicchiere
Glass / Verre / Zahnputzbecher / стакан
cm 9 L x 14 P x 12 H

• 08	€ 89,00
• 16 - 25 - 36	€ 115,00

MA 30 AP

Dosatore sapone con pompetta in metallo
Liquid soap dispenser / Porte savon liquid /
Seifenspender / дозатор
cm Ø 8 x 18 H

• 08	€ 115,00
• 16 - 25 - 36	€ 145,00

NEMI

Serie in ceramica bianca con base in ottone
White ceramic set with brass base
Série en céramique blanc avec base en laiton
Serie aus weißer Keramik mit Fuß aus Messing
серия из керамики на металлической ножке

N 09 AP

Porta sapone
Soap dish / Porte savon / Seifenschale /
мыльница
cm Ø 12 x 5 H

• 08	€ 78,00
• 16 - 25 - 36	€ 100,00

N 10 AP

Bicchiere
Glass / Verre / Zahnputzbecher / стакан
cm Ø 9 x 11 H

• 08	€ 78,00
• 16 - 25 - 36	€ 100,00

N 30 AP

Dosatore sapone con pompetta in metallo
Liquid soap dispenser / Porte savon liquid /
Seifenspender / дозатор
cm Ø 8 x 18 H

• 08	€ 105,00
• 16 - 25 - 36	€ 135,00



ELITE

Serie in vetro con base in ottone
Glass set with brass base
Série en verre avec base en laiton
Serie mit Fuß aus Messing
серия в стекле на металлической ножке

EL 09 AP

Porta sapone
Soap dish / Porte savon / Seifenschale / мыльница
cm 15 L x 14 P x 6 H

• 02 - 08	€ 78,00
• 16 - 25 - 36	€ 105,00

EL 10 AP

Bicchiere
Glass / Verre / Zahnputzbecher / стакан
cm 9 L x 14 P x 12 H

• 02 - 08	€ 86,00
• 16 - 25 - 36	€ 115,00

EL 30 AP

Dosatore sapone con pompetta in metallo
Liquid soap dispenser / Porte savon liquid /
Seifenspender / дозатор
cm Ø 8 x 18 H

• 02 - 08	€ 103,00
• 16 - 25 - 36	€ 140,00



GIUNONE

Serie in ceramica bianca con base in ottone
White ceramic set with brass base
Série en céramique blanc avec base en laiton
Serie aus weißer Keramik mit Fuß aus Messing
серия из керамики на металлической ножке

G 719

Porta sapone
Soap dish / Porte savon / Seifenschale / мыльница
cm 13 L x 10 P x 11 H

• 08	€ 86,00
• 02 - 03 - 04	€ 99,00
• 16 - 25 - 26 - 36	€ 115,00

G 718

Bicchiere
Glass / Verre / Zahnputzbecher / стакан
cm 10 L x 15 P x 15 H

• 08	€ 86,00
• 02 - 03 - 04	€ 99,00
• 16 - 25 - 26 - 36	€ 115,00

G 720

Dosatore sapone con pompetta in metallo
Liquid soap dispenser / Porte savon liquid /
Seifenspender / дозатор
cm Ø 12 x 18 H

• 08	€ 110,00
• 02 - 03 - 04	€ 125,00
• 16 - 25 - 26 - 36	€ 140,00



COMPLEMENTI

Designer: STILHAUS, SETTIMELLI, PAPA, PALUDI, BINZ

812

Vasca di vetro con ghiera di fissaggio
Glass washbasin with fixing ring
Lavabo en verre avec anneau de fixation
Glas Aufsatzwaschbecken rund mit Distanzring
Стеклянная раковина матовая
cm 37 Ø x 17 H

• Satinato/satin/satin/satiniert/Хром € 290,00

813

Supporto in acciaio con foro rubinetteria
Stainless steel wall bearing with hole for tap
Support en acier inox avec trou pour robinet
Wandhalterung aus Edelstahl für Glaswasch-
becken mit Loch
Настенный фиксатор для сифона
cm 32 P x 10 L x 10 H fori Ø 4,5/3,2

€ 135,00

814

Supporto in acciaio inox senza foro rubinetteria
Stainless steel wall bearing without hole for tap
Support en acier inox sans trou pour robinet
Wandhalterung aus Edelstahl für Glaswasch-
becken ohne Loch
Настенный фиксатор для сифона
cm 30 P x 10 L x 10 H foro ø 4,5

€ 125,00

RAC 488

Piletta di scarico lavabo Up&Down 1" ¼
Washbasin drain Up&Down 1" ¼
Vidage Up&Down pour lavabo 1" ¼
Ablaufventil Up&Down 1" ¼
Дренажного отверстия умывальник вверх и
вниз 1 ¼"
cm 6 H

€ 46,00

RAC 393

Sifone tornito in ottone cromato 1" ¼
Chromed brass siphon 1" ¼
Siphon en laiton chromé 1" ¼
Siphon aus verchromtem Messing 1" ¼
Хромированный сифон 1" ¼

€ 82,00



Blu satinato
Blue satin
Satin bleu
Blau satiniert
синий сатин



Rosso satinato
Red satin
Satin rouge
Rot satiniert
красный сатин



Arancio satinato
Orange satin
Satin oranger
Orange satiniert
красный сатин



Bianco satinato
White satin
Satin blanc
Weiß satiniert
Белая атласная



Verde satinato
Green satin
Satin vert
Grün satiniert
зеленый сатин

1273

Lavabo in cristallo inciso a mano
Shaped crystal wash basin
Lavabo en cristal
Waschbecken aus reinem Kristallglas
Раковина фигурная прозрачная
cm Ø 41 x 14 H

• TR € 1.200,00
• AB € 1.400,00



Dalla polvere al cristallo

Una miscela di granelli fonde a 1400°, riposa per ore fino all'azione delle canne da levata dei maestri vetrai che estraggono l'impasto, lo soffiano fino alle pareti dello stampo. Nasce la forma che renderà ogni oggetto simile, ma non uguale. Prima temperato per la prima severa selezione di qualità, poi sottoposto alla lavorazione a freddo. Nel cristallo, rispetto al vetro, vi è l'ossido di piombo che conferisce una rifrazione della luce che si avvicina alle proprietà ottiche del diamante ed una malleabilità del manufatto che ne permette l'incisione. Sono quindi i molatori che segano, nastrano, forano, levigano il pezzo; a loro volta i maestri incisori con le mole diamantate realizzano le decorazioni e le sfaccettature alleate della lucentezza e della duttilità. La presenza di bolle interne evidenzia l'artigianalità del prodotto e non sono da considerare un difetto.

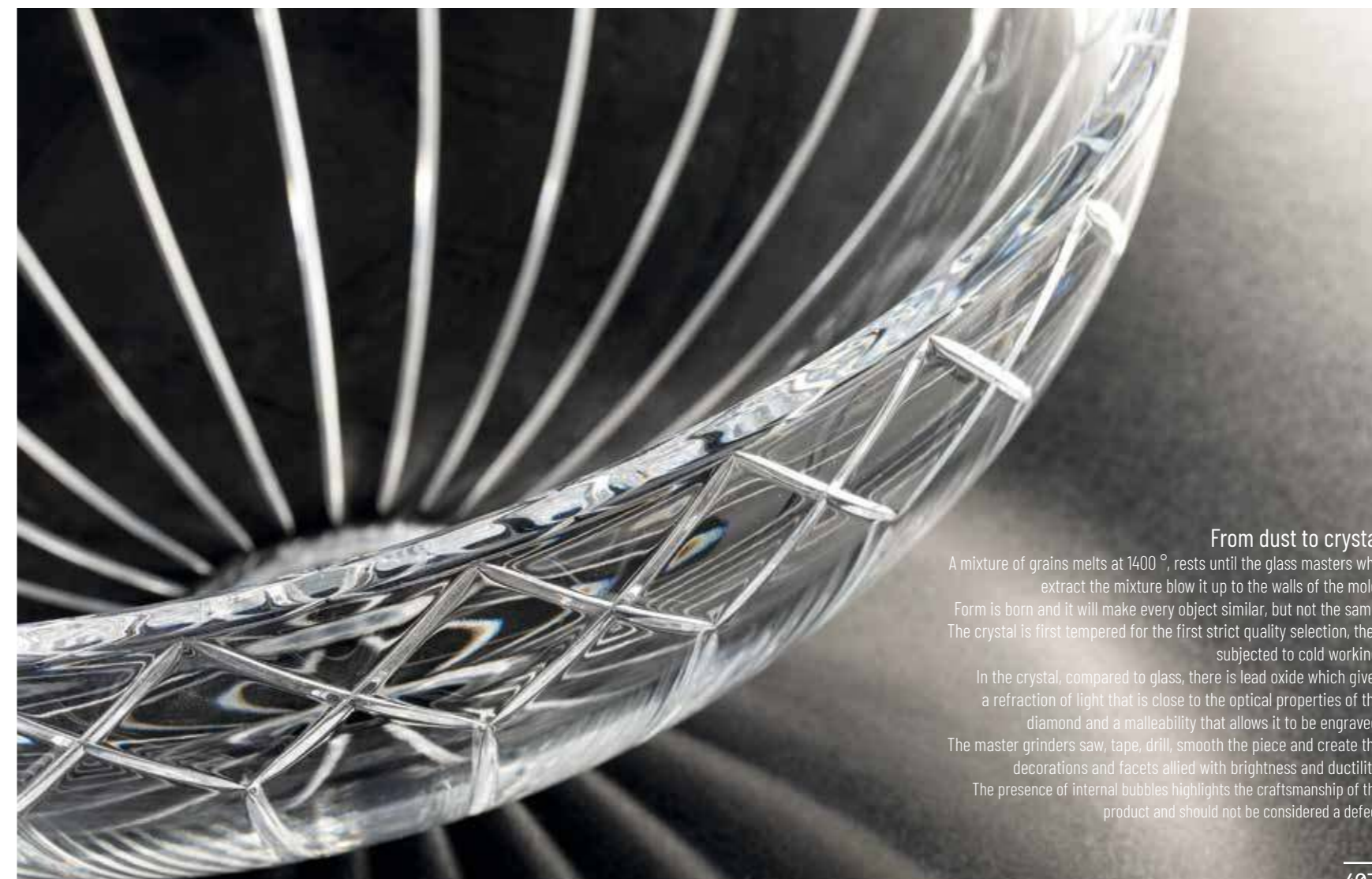

From dust to crystal

A mixture of grains melts at 1400°, rests until the glass masters who extract the mixture blow it up to the walls of the mold. Form is born and it will make every object similar, but not the same. The crystal is first tempered for the first strict quality selection, then subjected to cold working. In the crystal, compared to glass, there is lead oxide which gives a refraction of light that is close to the optical properties of the diamond and a malleability that allows it to be engraved. The master grinders saw, tape, drill, smooth the piece and create the decorations and facets allied with brightness and ductility. The presence of internal bubbles highlights the craftsmanship of the product and should not be considered a defect

COMPLEMENTI

1056

Contentore inox
Inox container
Élément mural en acier
Edelstahl-Inox
Контейнер из нержавеющей стали
cm 18 L x 10 P x 18 H

• 55	€ 68,00
• 01 - 23	€ 84,00

1057

Contentore inox
Inox container
Élément mural en acier
Edelstahl-Inox
Контейнер из нержавеющей стали
cm 36 L x 10 P x 18 H

• 55	€ 95,00
• 01 - 23	€ 105,00

1058

Contentore inox con porta salviette
Inox container with towerrail
Élément mural en acier avec porte serviettes
Edelstahl-Inox mit Handtuchhalter
Контейнер из нержавеющей стали с
полотенцедержателем
cm 36 L x 10 P x 184 H

• 55	€ 145,00
• 01 - 23	€ 160,00



1056 01



1057 01



1058 01



1056 23



1057 23



1058 23

COMPLEMENTI

852

Base inox con ruote, 4 cassetti
Unit on wheels with 4 drawers
Armoire d'appoint inox sur roulettes, 4 tiroirs
Rollenschrank aus Edelstahl, 4 Schubladen
Передвижная банкетка с 4-мя
выдвижными ящиками
cm 35 L x 30 P x 81 H

€ 660,00

853

Base inox con ruote, 2 cassetti, 1 anta vetro
Two drawers + one door on wheels
Armoire d'appoint inox sur roulettes, 2 tiroirs,
1 porte en verre
Rollenschrank aus Edelstahl, 2 Schubladen
und 1 Glasür
Передвижная банкетка с 2-мя выдвижными
ящиками и 1-й стеклянной распашной дверцей
cm 35 L x 30 P x 81 H

€ 630,00

854

Base inox con ruote, 1 cassetto, 1 anta vetro
One drawer + one door on wheels
Armoire d'appoint inox sur roulettes, 1 tiroir,
1 porte en verre
Rollenschrank aus Edelstahl, 1 Schubladen
und 1 Glasür
Передвижная банкетка с 1-м выдвижным
ящиком и 1-й стеклянной распашной дверцей
cm 35 L x 30 P x 81 H

€ 590,00

850

Colonna rotante inox con specchio
Stainless steel turning cabinet with mirror
Armoire tournant en inox avec mirror
Drehbarer Spiegel mit Edelstahlstange
Поворотная колонна на ножке с зеркалом
cm 25 L x 15 P x 165 H

€ 710,00





DRY_1318

Porta salviette per termoarredo, aperto/chiuso
Towel holder for towel warmer, open/closed
Porte-serviettes pour sèche-serviettes, ouvert/fermé
Handtuchhalter für Handtuchwärmer, offen/geschlossen
Держатель полотенец для полотенцесушителя, открытый/закрытый
cm 37 L x 35 P x 15 H

• 08 - 23 - 24

€ 195,00

DRY_1353

Porta salviette per termoarredo, aperto/chiuso
Drying rack for radiator, open/close
Porte-serviettes pour radiateur sèche-serviettes, ouvert/fermé
Handtuchhalter für Handtuchheizkörper, offen/geschlossen
Держатель полотенец для терморегулятора, открытый/закрытый
cm 35 L x 35 P x 15 H

• 08 - 23 - 24

€ 125,00

COMPLEMENTI

944

Porta piastra per capelli in ottone
Hair straightener holder in brass
Porte lisseur à cheveux
Halter für Haarglätter
Латунь, дверная для волос
cm 5 L x 13 P x 12 H

• 08 - 23 € 78,00
• 16 - 25 € 98,00



16



23



25

955

Porta phon in ottone
Brass hair dryer holder
Porte sèche-cheveux
Föhnhalter
Латунь, дверь Пхон
cm 8 L x 15 P x 7 H

• 08 - 23 € 72,00
• 16 - 25 € 92,00



16



23



25



840

Kit collante e biadesivo per un articolo
Kit with bi-adhesive and glue for one article
Kit avec collant et biadhésif pour un article
Klebekit ist ein beidseitiger Klebestreifen
Возможность установки на клей.Біфдгеш

• € 4,80



COMPLEMENTI

1144 OTTO

Porta spazzolini elettrico
Electric toothbrush holder
Porte brosse à dents lectreque
Halter für elektrische Zahnbürsten
Держатель зубной щетки
cm 9 L x 6 P x 5 H

• 08 € 65,00



1145 OTTOPLUS

Porta spazzolino elettrico
Electric toothbrush holder
Porte brosse à dents lectreque
Halter für elektrische Zahnbürsten
Держатель зубной щетки
cm 8 L x 10 P x 9 H

• 08 € 99,00

840

Kit collante e biadesivo per un articolo
Kit with bi-adhesive and glue for one article
Kit avec collant et biadhésif pour un article
Klebekit ist ein beidseitiger Klebestreifen
Возможность установки на клей.Біфдгеш

• € 4,80



COMPLEMENTI

1146

Carrello 3 piani in cristallo
3 storey glass trolley
Chariot en verre de 3 étages
Glasböden mit 3 glasböden
3-х ярусная стеклянная этажерка
cm 40 L x 30 P x 80 H

• 08	€ 550,00
• 25 - 16	€ 680,00



16



25



COMPLEMENTI

1274

Tavolo bordo vasca con marmo
Marble pool table
Table de pool en marbre
Billardtisch aus Marmor
Мраморный бильярдный стол
cm Ø 32 x 67 H

• 08 - 23	€ 490,00
• 18 - 36	€ 600,00

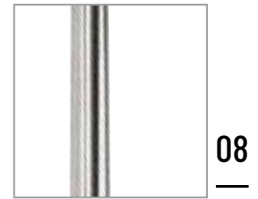

08

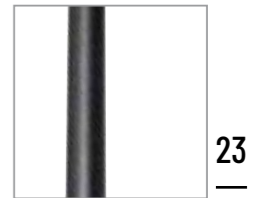

23

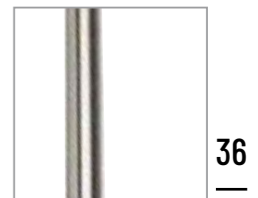

36

PORTA SCOPINI

010 DIECI da appoggio

Positioned to floor
Freistehend
Напольный
Cm Ø 8 x 41 H

• 08 - 23 - 24	€ 89,00
• 16 - 25 - 36	€ 115,00

010 M DIECI da parete

Positioned to wall
Wandmontage
Настенный
cm 8L x 9 P x 41 H

• 08 - 23 - 24	€ 98,00
• 16 - 25 - 36	€ 125,00



- 1 Manico e coperchio in ottone cromato
- 2 Sottocoperchio centratore con trattamento antibatterico
- 3 Ciuffo in setola intercambiabile con legatura in filo nichel-silver antiruggine con trattamento antibatterico
- 4 Contenitore interno estraibile in polipropilene con trattamento antibatterico
- 5 Cilindro esterno in ottone cromato
- 6 Base in ABS cromato appoggio soft

- 1 Handle and cover in chrome brass
- 2 Conical self-centering cover with antibacterial treatment
- 3 Bristle tuft interchangeable with nickel / silver ligature with antibacterial treatment
- 4 Removable inner part in polypropylene plastic with antibacterial treatment
- 5 Outer cylinder in chrome plated brass
- 6 Base in chromed abs, soft set down

- 1 Poignée et couvercle en laiton chromé
- 2 Centrage Innerplate avec traitement antibactérien
- 3 Touffe Bristle interchangeable avec reliure spirale rouille nickel-argent traitement antimicrobien
- 4 Récipient intérieur amovible en polypropylène avec traitement antibactérien
- 5 Cylindre externe laiton chromé
- 6 Base en ABS chrome appui douce

- 1 Stiel und Deckel aus verchromtem Messing
- 2 Zentrier-Topfschale mit antibakterieller Behandlung
- 3 Austauschbarer Bürstenkopf mit antibakterieller Behandlung
- 4 Herausnehmbarer Polypropylen-Einsatz mit antibakterieller Behandlung
- 5 Behälter aus verchromtem Messing
- 6 ABS-verchromter Soft-Touch-Fuß

- 1 Ручка и крышка из хромированной латуни
- 2 под крышкой центрирующее устройство с антибактериальное лечение
- 3 сменные насадки в переплете с никелево-серебряной антикоррозионной нитью с антибактериальное лечение
- 4 внутренний выдвигающийся контейнер из полипропилена с антибактериальное лечение
- 5 внешний цилиндр из хромированной латуни
- 6 основа из ABS

TRATTAMENTO ANTIBATTERICO

antibacterial treatment
traitement antibactérien
antibakteriell behandelt
антибактериальное лечение

TRATTAMENTO ANTIBATTERICO

antibacterial treatment
traitement antibactérien
antibakteriell behandelt
антибактериальное лечение



- 1 Manico e coperchio in ottone cromato
- 2 Sottocoperchio centratore con trattamento antibatterico
- 3 Ciuffo in setola intercambiabile con legatura in filo nichel-silver antiruggine con trattamento antibatterico
- 4 Contenitore interno estraibile in polipropilene con trattamento antibatterico
- 5 Cilindro esterno in ottone cromato
- 6 Base in ABS cromato appoggio soft

- 1 Handle and cover in chrome brass
- 2 Conical self-centering cover with antibacterial treatment
- 3 Bristle tuft interchangeable with nickel / silver ligature with antibacterial treatment
- 4 Removable inner part in polypropylene plastic with antibacterial treatment
- 5 Outer cylinder in chrome plated brass
- 6 Base in chromed abs, soft set down

- 1 Poignée et couvercle en laiton chromé
- 2 Centrage Innerplate avec traitement antibactérien
- 3 Touffe Bristle interchangeable avec reliure spirale rouille nickel-argent traitement antimicrobien
- 4 Récipient intérieur amovible en polypropylène avec traitement antibactérien
- 5 Cylindre externe laiton chromé
- 6 Base en ABS chrome appui douce

- 1 Stiel und Deckel aus verchromtem Messing
- 2 Zentrier-Topfschale mit antibakterieller Behandlung
- 3 Austauschbarer Bürstenkopf mit antibakterieller Behandlung
- 4 Herausnehmbarer Polypropylen-Einsatz mit antibakterieller Behandlung
- 5 Behälter aus verchromtem Messing
- 6 ABS-verchromter Soft-Touch-Fuß

- 1 Ручка и крышка из хромированной латуни
- 2 под крышкой центрирующее устройство с антибактериальное лечение
- 3 сменные насадки в переплете с никелево-серебряной антикоррозионной нитью с антибактериальное лечение
- 4 внутренний выдвигающийся контейнер из полипропилена с антибактериальное лечение
- 5 внешний цилиндр из хромированной латуни
- 6 основа из ABS



PORTA SCOPINI

020 VENTI da appoggio

Positioned to floor
Freistehend
Напольный
cm 9,5 L x 9,5 P x 41 H

• 08 - 23	€ 185,00
• 16 - 36	€ 240,00

020 M VENTI da parete

Positioned to wall
Wandmontage
Настенный
cm 9,5 L x 10,5 P x 41 H

• 08 - 23	€ 210,00
• 16 - 36	€ 270,00





1200 SWITCH BIANCO

Porta scopino in ceramica a parete e da appoggio
 Wall mounted and on floor ceramic toilet brush
 Porte balayent en céramique d'appui et à mur
 Bürstengarnitur aus Keramik zur Wandmontage
 oder freistehend
 Настенный и напольный керамический ёрш
 cm 12 L x 13,5 P x 40 H

- 08 - 23 € 105,00
- 16 - 18 - 36 € 120,00



SWITCH colori disponibili
 available colours / couleurs disponibles / verfügbare Farben / доступные цвета



Guarda il video sul nostro canale youtube / Watch the video on our youtube channel
 Regardez la vidéo sur notre chaîne Youtube / Sehen Sie sich das Video auf unserem Youtube-Kanal an
 Смотрите видео на нашем канале youtube



Brevetto Europeo N. 7794383-001
 European Patent No. 7794383-001
 Brevet Européen No. 7794383-001
 Europäisches Patent Nr. 7794383-001
 Европейский патент No 7794383-001

1200 SWITCH NERO

Porta scopino in ceramica a parete e da appoggio
 Wall mounted and on floor ceramic toilet brush
 Porte balayent en céramique d'appui et à mur
 Bürstengarnitur aus Keramik zur Wandmontage
 oder freistehend
 Настенный и напольный керамический ёрш
 cm 12 L x 13,5 P x 40 H

- 08 - 23 € 115,00
- 16 - 18 - 36 € 130,00

Brevetto Europeo N. 7794383-001
 European Patent No. 7794383-001
 Brevet Européen No. 7794383-001
 Europäisches Patent Nr. 7794383-001
 Европейский патент No 7794383-001



SWITCH colori disponibili
 available colours / couleurs disponibles / verfügbare Farben / доступные цвета



PORTA SCOPINI

1946

Scopino a parete adatto a sanitari a risparmio idrico
 Wall-mounted brush suitable for water-saving sanitary fixtures
 Brosse murale adaptée aux équipements sanitaires à économie d'eau
 Wandbürste geeignet für wassersparende Sanitärreinrichtungen
 Настенная щётка подходит для водосберегающих сантехнических приборов
cm 6,5 L x 8 P x 40,5 H

• 08 - 23 - 24	€ 72,00
• 16 - 18 - 36	€ 105,00
• FN	€ 115,00

1946 AP

Porta scopino da appoggio adatto a sanitari a risparmio idrico
 Freestanding toilet brush holder suitable for water-saving toilets
 Porte-balayette sur pied adapté aux toilettes à faible consommation d'eau
 Freistehender Toilettenbürstenhalter geeignet für wassersparende Toiletten
 Подставка для щётки подходит для сантехники с экономией воды
cm 10 L x 10 P x 41,5 H

• 08 - 23 - 24	€ 80,00
• 16 - 18 - 36	€ 114,00
• FN	€ 125,00

840

Kit collante e biadesivo per un articolo
 Kit with bi-adhesive and glue for one article
 Kit avec collant et biadhésif pour un article
 Klebekit ist ein beidseitiger Klebestreifen
 Возможность установки на клей.Біфдгеш

•	€ 4,80
---	--------



17



36



16



18



08



23



24



PORTA SCOPINI

1948

Scopino a parete adatto a sanitari a risparmio idrico
 Wall-mounted brush suitable for water-saving sanitary fixtures
 Brosse murale adaptée aux équipements sanitaires à économie d'eau
 Wandbürste geeignet für wassersparende Sanitärreinrichtungen
 Настенная щётка подходит для водосберегающих сантехнических приборов
cm 6,5 L x 8 P x 40,5 H

• 08 - 23	€ 125,00
-----------	----------

1948 AP

Porta scopino da appoggio adatto a sanitari a risparmio idrico
 Freestanding toilet brush holder suitable for water-saving toilets
 Porte-balayette sur pied adapté aux toilettes à faible consommation d'eau
 Freistehender Toilettenbürstenhalter geeignet für wassersparende Toiletten
 Подставка для щётки подходит для сантехники с экономией воды
cm 10 L x 10 P x 41,5 H

• 08 - 23	€ 145,00
-----------	----------

840

Kit collante e biadesivo per un articolo
 Kit with bi-adhesive and glue for one article
 Kit avec collant et biadhésif pour un article
 Klebekit ist ein beidseitiger Klebestreifen
 Возможность установки на клей.Біфдгеш

•	€ 4,80
---	--------



08



23



PORTA SCOPINI

VE 039 PRATIKO

Porta scopino da appoggio con coperchio telescopico
Toilet brush with telescopic cover
Porte balayent d'appui avec couvercle télescopique
Bürstengarnitur freistehend mit Teleskopgriff
Напольный металлический ёрш с телескопической крышкой
cm Ø 12,5 x 54 H

• 08 € 130,00

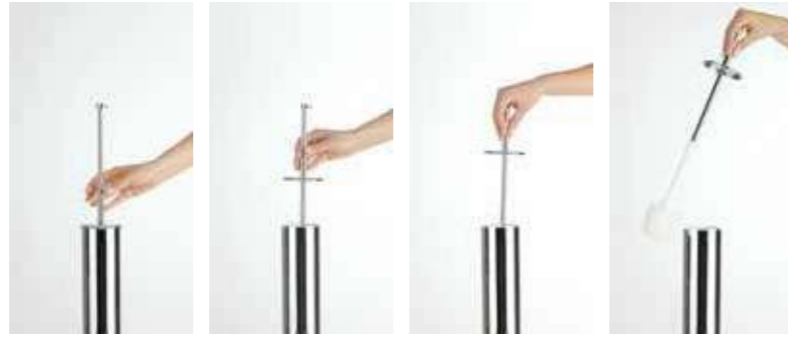

VE 039 PRATIKO

646 ZEFIRO [design Claudio Papa]

Porta scopino in ceramica da appoggio con diffusore di profumo e una essenza profumata
Ceramic toilet brush with scent diffuser and one perfumed essence
Porte balayent en céramique d'appui avec diffuseur de parfume et une essence parfumée
Bürstengarnitur aus Keramik freistehend mit Duftspender und Duftessenz
Напольный керамический ёрш с ароматизатором
cm 13 L x 10 P x 42 H

• 08 bianco/white/blanc/weiß/белый € 130,00
• 08 colorato/colored/colorée/farbig/черный € 140,00



ZEFIRO colori disponibili / available colours / couleurs disponibles / verfügbare Farben / доступные цвета



BIANCO
white / blanc /
weiß / белый



VERDE
green / vert /
grün / зеленый



ROSSO
red / rouge /
rot / красный



ARANCIO
orange / orangier /
orange / оранжевый



LILLA
lilac / lile /
lila / сирень



NERO
black / noir /
schwarz / черный

PORTA SCOPINI

AR 039

Porta scopino ovale in ottone da appoggio
Oval brass toilet-brush with base
Porte balayent oval en laiton d'appui
Bürstengarnitur freistehend oval aus Messing
Напольный металлический ёрш
cm 9 L x 10 P x H 38

• 08 € 209,00
• 36 € 260,00

AR 039 M

Porta scopino ovale in ottone a parete
Wall-mounted oval brass toilet-brush
Porte balayent oval en laiton à mur
Bürstengarnitur wandhängend oval aus Messing
Настенный металлический ёрш
cm 9 L x 10 P x H 38

• 08 € 228,00
• 36 € 290,00



AR 039 / AR 039 M

U 039Q URANIA

Porta scopino in ottone da appoggio
Brass toilet-brush with base
Porte balayent en laiton d'appui
Bürstengarnitur freistehend aus Messing
Напольный металлический ёрш
cm 8 L x 8 P x 41 H

• 08 - 23 € 178,00
• 36 € 240,00

URANIA



U 039Q / U 039 M

U 039M URANIA

Porta scopino quadrato in ottone a parete
Wall mounted square brass toilet-brush
Porte balayent cadre en laiton à mur
Bürstengarnitur wandhängend aus Messing
Настенный металлический ёрш
cm 8 L x 9 P x 41 H

• 08 € 198,00
• 36 € 260,00

PORTA SCOPINI

995

Porta scopino in ABS e in ottone
ABS or brass toilet brush holder
Porte-brosse de toilette en ABS ou en laiton
Toilettenbürstenhalter aus ABS oder Messing
Держатель туалетного ершика из ABS или латуни
cm Ø 9 x 43 H

• 08 ABS Cromo /	€ 45,00
• 23 ABS Nero /	€ 45,00

1215 TONDO

Porta scopino da appoggio INOX 304
INOX 304 toilet-brush with base
Porte balayent d'appui INOX 304
Bürstengarnitur freistehend aus INOX 304
Держатель щётки для унитаза из нержавеющей стали 304
cm Ø 8 x 42 H

• 55	€ 55,00
• 54	€ 75,00

1216 QUADRATO

Porta scopino da appoggio INOX 304
INOX 304 toilet-brush with base
Porte balayent d'appui INOX 304
Bürstengarnitur freistehend aus INOX 304
Держатель щётки для унитаза из нержавеющей стали 304
cm 9 L x 9 P x 41 H

• 55	€ 89,00
• 54	€ 105,00

SM 039 CIKO

Porta scopino in ottone da appoggio
con base in PVC
Brass toilet brush with PVC base
Porte balayent en laiton d'appui avec base en PVC
Bürstengarnitur aus Messing freistehend mit
Sockel aus PVC
Напольный металлический ёрш
cm Ø 8 x 36 H

• 08	€ 75,00
• 02	€ 84,00
• 16 - 25	€ 110,00

SM 039M CIKO

Porta scopino in ottone a parete
Wall mounted brass toilet brush
Porte balayent en laiton à mur
Bürstengarnitur wandhängend aus Messing
Настенный металлический ёрш
cm Ø 9 x 36 H

• 08	€ 86,00
• 02	€ 92,00
• 16 - 25	€ 110,00

SM 039 B

Porta scopino da appoggio con base
Toilet brush with base
Porte balayent d'appui
Bürstengarnitur freistehend
Напольный металлический ёрш
cm 12,5 Ø x 40 H

• 08	€ 110,00
• 16 - 25	€ 140,00

424



995 23



995 08



1216



1215



CIKO

SM 039 / SM 039 M



SM 039 B



186

CUBE



633



SM 12 A

GABRY



186.40



DV 12 A



BK 12 A

PORTA SCOPINI

186 GABRY

Porta scopino in ceramica da appoggio
Ceramic toilet brush with base
Porte balayent en céramique d'appui
Bürstengarnitur freistehend aus Keramik
Напольный керамический ёрш
cm 13 Ø x 35 H

• 02 - 08	€ 75,00
• 39	€ 89,00
• 40	€ 115,00

633 CUBE

Porta scopino in ceramica da appoggio
Ceramic toilet-brush with base
Porte balayent en céramique d'appui
Bürstengarnitur freistehend aus Keramik
Напольный керамический ёрш
cm 10 L x 10 P x 38 H

• 08	€ 97,00
• 36	€ 124,00

DV 12 A [design Massimiliano Settini]

Porta scopino in ceramica da appoggio
Ceramic toilet brush with base
Porte balayent en céramique d'appui
Bürstengarnitur freistehend aus Keramik
Напольный керамический ёрш
cm 10L x10 P x 40 H

• 08	€ 104,00
------	----------

SM 12 A

Porta scopino in ceramica da appoggio
Ceramic toilet brush with base
Porte balayent en céramique d'appui
Bürstengarnitur freistehend aus Keramik
Напольный керамический ёрш
cm 13 Ø x 40 H

• 08	€ 85,00
• 25 - 26	€ 105,00

BK 12 A [design Giovanna Talocci]

Porta scopino in ceramica
Ceramic Toilet-brush
Porte balayent en céramique
Bürstengarnitur wandhängend
Напольный керамический ёрш
cm Ø 10 x 42 H

• 08	€ 99,00
------	---------

425



TT 01

Maniglione di sicurezza in ottone cm 30
Brass safety handle cm 30
Poignée de sécurité en laiton cm 30
Sicherheitsgriff aus Messing cm 30
Латунная предохранительная ручка см 30
cm 35,5 L x 8 P x 3 H

• 08 - 03 - 05	€ 94,00
• 36	€ 115,00



TT 02

Maniglione di sicurezza in ottone cm 45
Brass safety handle cm 45
Poignée de sécurité en laiton cm 45
Sicherheitsgriff aus Messing cm 45
Латунная предохранительная ручка см 45
cm 45,5 L x 8 P x 3 H

• 08 - 03 - 05	€ 100,00
• 36	€ 125,00



TT 03

Maniglione di sicurezza in ottone cm 60
Brass safety handle cm 60
Poignée de sécurité en laiton cm 60
Sicherheitsgriff aus Messing cm 60
Латунная предохранительная ручка см 60
cm 60,5 L x 8 P x 3 H

• 08 - 03 - 05	€ 110,00
• 36	€ 138,00



TT 04

Maniglione di sicurezza in ottone cm 80
Brass safety handle cm 80
Poignée de sécurité en laiton cm 80
Sicherheitsgriff aus Messing cm 80
Латунная предохранительная ручка см 80
cm 80,5 L x 8 P x 3 H

• 08 - 03 - 05	€ 125,00
• 36	€ 155,00



TT 05

Asta per connessione a "T" cm 30
Rod for "T" connection cm 30
Tige pour raccord en "T" cm 30
Stange für "T"-Verbindung cm 30
Стержень для "Т" соединения см 30
cm 38,5 L x 8,5 P x 3,5 H

• 08 - 03 - 05	€ 128,00
• 36	€ 160,00



TT 06

Asta per connessione a "T" cm 45
Rod for "T" connection cm 45
Tige pour raccord en "T" cm 45
Stange für "T"-Verbindung cm 45
Стержень для "Т" соединения см 45
cm 48,5 L x 8,5 P x 3,5 H

• 08 - 03 - 05	€ 135,00
• 36	€ 169,00



TT 07

Asta per connessione a "T" cm 60
Rod for "T" connection cm 60
Tige pour raccord en "T" cm 60
Stange für "T"-Verbindung cm 60
Стержень для "Т" соединения см 60
cm 63,5 L x 8,5 P x 3,5 H

• 08 - 03 - 05	€ 142,00
• 36	€ 182,00



TT 08

Asta per connessione a "T" cm 80
Rod for "T" connection cm 80
Tige pour raccord en "T" cm 80
Stange für "T"-Verbindung cm 80
Стержень для "Т" соединения см 80
cm 83,5 L x 8,5 P x 3,5 H

• 08 - 03 - 05	€ 170,00
• 36	€ 210,00



TT 09

Maniglione di sicurezza in ottone cm 120
Brass safety handle cm 120
Poignée de sécurité en laiton cm 120
Sicherheitsgriff aus Messing cm 120
Латунная предохранительная ручка см 120
cm 120,9 L x 8,5 P x 3 H

• 08 - 03 - 05	€ 200,00
• 36	€ 250,00



TT 50

Doccetta completa di supporto e tubo
Shower complete with stand and hose
Douche complète avec support et tuyau
Dusche komplett mit Ständer und Schlauch
Душ в комплекте со стойкой и шлангом
cm 120,9 L x 4 P x 5 H

• 08	€ 75,00
• 03 - 05	€ 115,00



TT 51

Porta accappatoio per barra
Bathrobe holder for bar
Support de peignoir pour le bar
Bademantelhalter für Stange
Держатель банного халата для барной стойки
cm 6,5 L x 4 P x 5 H

• 08 - 03 - 05	€ 37,00
• 36	€ 48,00



TT 12

Vaschetta plexiglass per barra orizzontale
Plexiglas tray for horizontal bar
Plateau en plexiglas pour barre horizontale
Plexiglasschale für horizontale Stange
Лоток из оргстекла для горизонтальной полосы
cm 25 L x 14 P x 12 H

•	€ 42,00
---	---------



TT 1283

Maniglia reclinabile
 Reclining handle
 Poignée inclinable
 Verstellbarer Griff
 Откидывающаяся ручка
 BASE cm 9 L x 16 H
 APERTA cm 65 P x 16 H
 CHIUSA cm 12 P x 75 H

• 08 - 03 - 05	€ 275,00
• 36	€ 350,00



TT 1283

TT 1284

Maniglia reclinabile con porta rotolo
 Reclining handle with roll holder
 Poignée inclinable avec porte-rouleau
 Verstellbarer Griff mit Rollenhalter
 Откидывающаяся ручка с держателем для рулона
 BASE cm 9 L x 16 H
 APERTA cm 65 P x 16 H
 CHIUSA cm 12 P x 75 H

• 08 - 03 - 05	€ 290,00
• 36	€ 370,00



TT 1284



08



05



03



36



1152

Maniglione di sicurezza in ottone ad angolo
 Brass mergency handle
 Poignée de sûreté en laiton
 Bad Sicherheitsgriff aus Messing
 Поручень
 cm 47 L x 10 P x 18 H x Ø 3

• 08	€ 210,00
• 16 - 25	€ 265,00
• FN	€ 315,00



1152

1153

Maniglione di sicurezza in ottone
 Brass mergency handle
 Poignée de sûreté en laiton
 Bad Sicherheitsgriff aus Messing
 Поручень
 cm 35 L x 9 P x 6 H x Ø 3

• 08	€ 175,00
• 16 - 25	€ 220,00
• FN	€ 260,00



1153

1154

Maniglione di sicurezza in ottone
 Brass mergency handle
 Poignée de sûreté en laiton
 Bad Sicherheitsgriff aus Messing
 Поручень
 cm 45 L x 9 P x 6 H x Ø 3

• 08	€ 180,00
• 16 - 25	€ 225,00
• FN	€ 270,00



1154

1155

Maniglione di sicurezza in ottone
 Brass mergency handle
 Poignée de sûreté en laiton
 Bad Sicherheitsgriff aus Messing
 Поручень
 cm 60 L x 9 P x 6 H x Ø 3

• 08	€ 200,00
• 16 - 25	€ 250,00
• FN	€ 300,00



1155

1156

Maniglione di sicurezza in ottone
 Brass mergency handle
 Poignée de sûreté en laiton
 Bad Sicherheitsgriff aus Messing
 Поручень
 cm 80 L x 9 P x 6 H x Ø 3

• 08	€ 210,00
• 16 - 25	€ 275,00
• FN	€ 315,00



1156



16

25



FN*

PROGETTO SARTORIA
 Tailoring project
 Finishes on request
 finitions sur demande
 Ausführungen auf Anfrage
 отделка по запросу



1147

Maniglione di sicurezza in ottone ad angolo
 Brass mergency handle
 Poignée de sûreté en laiton
 Bad Sicherheitsgriff aus Messing
 Поручень
 cm 47 L x 10 P x 18 H x Ø 3

• 08	€ 189,00
• 36	€ 245,00
• FN	€ 280,00



1147

1148

Maniglione di sicurezza in ottone
 Brass mergency handle
 Poignée de sûreté en laiton
 Bad Sicherheitsgriff aus Messing
 Поручень
 cm 35 L x 9 P x 6 H x Ø 3

• 08	€ 165,00
• 36	€ 215,00
• FN	€ 250,00



1148

1149

Maniglione di sicurezza in ottone
 Brass mergency handle
 Poignée de sûreté en laiton
 Bad Sicherheitsgriff aus Messing
 Поручень
 cm 45 L x 9 P x 6 H x Ø 3

• 08	€ 178,00
• 36	€ 220,00
• FN	€ 265,00



1149

1150

Maniglione di sicurezza in ottone
 Brass mergency handle
 Poignée de sûreté en laiton
 Bad Sicherheitsgriff aus Messing
 Поручень
 cm 60 L x 9 P x 6 H x Ø 3

• 08	€ 189,00
• 36	€ 245,00
• FN	€ 280,00



1150

1151

Maniglione di sicurezza in ottone
 Brass mergency handle
 Poignée de sûreté en laiton
 Bad Sicherheitsgriff aus Messing
 Поручень
 cm 80 L x 9 P x 6 H x Ø 3

• 08	€ 205,00
• 36	€ 265,00
• FN	€ 300,00



1151



36



FN*

PROGETTO SARTORIA
 Tailoring project
 Finishes on request
 finitions sur demande
 Ausführungen auf Anfrage
 отделка по запросу



233 / 1231

Maniglione di sicurezza in ottone ad angolo
 Brass mergency handle
 Poignée de sûreté en laiton
 Bad Sicherheitsgriff aus Messing
 Поручень
 cm 41 L x 10 P x 18 H x Ø 2

• 1231 08	HQC	€ 62,00
• 233 08		€ 115,00
• 233 16 - 233 25		€ 140,00



233
1231

884 / 1235

Maniglione di sicurezza in ottone con griglia
 Brass mergency handle with rack
 Poignée de sûreté en laiton avec grille
 Bad Sicherheitsgriff mit Seifenkorb
 Поручень + решетка
 cm 42 L x 11,5 P x 16 H x Ø 2

• 1235 08	HQC	€ 89,00
• 884 08		€ 158,00
• 884 16 - 884 25		€ 195,00



884
1235

885 / 1232

Maniglione di sicurezza in ottone
 Brass mergency handle
 Poignée de sûreté en laiton
 Bad Sicherheitsgriff
 Поручень
 cm 30 L x 10 P x 5 H x Ø 2

• 1232 08	HQC	€ 59,00
• 885 08		€ 110,00
• 885 16 - 885 25		€ 135,00



885
1232

886 / 1233

Maniglione di sicurezza in ottone
 Brass mergency handle
 Poignée de sûreté en laiton
 Bad Sicherheitsgriff
 Поручень
 cm 45 L x 10 P x 5 H x Ø 2

• 1233 08	HQC	€ 65,00
• 886 08		€ 130,00
• 886 16 - 886 25		€ 158,00



886
1233

887 / 1234

Maniglione di sicurezza in ottone
 Brass mergency handle
 Poignée de sûreté en laiton
 Bad Sicherheitsgriff
 Поручень
 cm 60 L x 10 P x 5 H x Ø 2

• 1234 08	HQC	€ 70,00
• 887 08		€ 145,00
• 887 16 - 887 25		€ 178,00



887
1234



16

25



076

Asta per tenda doccia
 Brass support bar for tent
 Barre de supporte en laiton pour tende
 Stange aus Messing für Duschvorhang
 Угловая перекалдина для занавесок в ванную
 cm 80 L x 80 P x Ø 2

• 08	€ 165,00
• 25 - 16	€ 205,00



076

082

Asta per tenda vasca con rompi tratta
 Brass support bar for tent
 Barre de supporte en laiton pour tende
 Stange aus Messing für Duschvorhang
 Угловая перекалдина для занавесок в ванную
 cm 170 L x 80 P x Ø 2

• 08	€ 225,00
• 25 - 16	€ 279,00



082

078

Asta curva per tenda doccia
 Brass curved support bar for tent
 Barre de supporte courbe en laiton pour tende
 Stange rund aus Messing für Duschvorhang
 Полукруглая перекалдина для занавесок в ванную
 cm 80 L x 80 P x Ø 2 R 55

• 08	€ 215,00
• 25 - 16	€ 275,00



078

079

Asta per tenda doccia
 Brass support bar for tent
 Barre de supporte en laiton pour tende
 Stange aus Messing für Duschvorhang
 Полукруглая перекалдина для занавесок в ванную
 cm 88/90 L x Ø 2

• 08	€ 130,00
• 25 - 16	€ 169,00



079



ORO
 Gold
 Gold
 золото

BRONZO
 Bronze
 Bronze
 Бронза

16

25





075 *
Tenda doccia in tessuto di poliestere plastificato
Polyester material shower tent
Tende douche dans tissu de polyester
Duschvorhang Textil aus Polyester
Душевая занавеска из полиэстера

• 075.00 cm 120 L x 200 H	€ 45,00
• 075.01 cm 180 L x 200 H	€ 56,00
• 075.02 cm 240 L x 200 H	€ 69,00



075 NIDO D'APE BIANCO *
Tenda doccia in tessuto di poliestere plastificato
Polyester material shower tent
Tende douche dans tissu de polyester
Duschvorhang Textil aus Polyester
Душевая занавеска из полиэстера

• 075.01 APBI cm 180 L x 200 H	€ 79,00
--------------------------------	---------



075 NIDO D'APE ECRÙ *
Tenda doccia in tessuto di poliestere plastificato
Polyester material shower tent
Tende douche dans tissu de polyester
Duschvorhang Textil aus Polyester
Душевая занавеска из полиэстера

• 075.01 APBC cm 180 L x 200 H	€ 79,00
--------------------------------	---------



075 CRASH BIANCO *
Tenda doccia in tessuto di poliestere plastificato
Polyester material shower tent
Tende douche dans tissu de polyester
Duschvorhang Textil aus Polyester
Душевая занавеска из полиэстера

• 075.01 CRBI cm 180 L x 200 H	€ 79,00
--------------------------------	---------



075 LINEUM BIANCO *
Tenda doccia in tessuto di poliestere plastificato
Polyester material shower tent
Tende douche dans tissu de polyester
Duschvorhang Textil aus Polyester
Душевая занавеска из полиэстера

• 075.01 LMBI cm 180 L x 200 H	€ 79,00
--------------------------------	---------



075 LINEUM ECRÙ *
Tenda doccia in tessuto di poliestere plastificato
Polyester material shower tent
Tende douche dans tissu de polyester
Duschvorhang Textil aus Polyester
Душевая занавеска из полиэстера

• 075.01 LMEC cm 180 L x 200 H	€ 79,00
--------------------------------	---------



080
Supporto in ottone per tenda doccia
Brass support for tent
Supporte en laiton pour tende
Aufhängung aus Messing für Duschvorhang
Круглая перекалдина для занавесок в ванную
cm 80 Ø x 84 P x 10 H

• 08	€ 460,00
• 25-16	€ 580,00

083
Ganci per tenda doccia
Curtain hooks for tent
Crochets de rideau pour tende
Vorhanghaken
Крючок для занавесок
cm 3 L x 6 H

• 55	€ 1,70
------	--------

8 pz x tenda / tent / tende / Vohrang / палатка cm 120 L
12 pz x tenda / tent / tende / Vohrang / палатка cm 180 L
16 pz x tenda / tent / tende / Vohrang / палатка cm 240 L



083

SEDILI

1354

Sedile per doccia ribaltabile, realizzato in ABS
Foldable shower seat, made of ABS
Siège de douche rabattable, en ABS
Klappbarer Duschsitz, aus ABS
Складное душевое сиденье, изготовленное из ABS
cm 40 L x 41,8 P x 8 H

• 01 € 310,00

Kg 150 Carico statico

Static load/Charge statique/Statische Belastung



1354

643

Sedile doccia, alluminio e polipropilene
Aluminum and polypropylene seat for shower
Siège pour douche, aluminium et polypropylène
Duschsitz in Aluminium und Polypropylen
Сиденье в душевой угол
cm 12/47 P x 42 L

• 01 € 230,00

Kg 110 Carico statico

Static load/Charge statique/Statische Belastung
CE norma MDD 93/42



643

033.01

Sedile per vasca con seduta in plastica
Seat for bath-tub with plastic sitting
Siège pour baignoire avec séance en plastique
Badewannensitz aus Kunststoff
Сиденье для ванны
cm 65/70 L x 28 P x 18 H

• 01 € 95,00

Kg 80 Carico statico

Static load/Charge statique/Statische Belastung



033.01

SEDILI

1085 - SEDILE DOCCIA

Sedile doccia in acciaio e plexiglass
Steel and plexiglass seat for shower
Siège pour douche en acier et plexiglas
Duschsitz aus Stahl und Plexiglas
Сиденье в душевой угол
cm 32 L x 7/33 P x 33/7 H

• 55 € 370,00

Kg 160 Carico statico

Static load/Charge statique/Statische Belastung



839

HQC

Pulisci vetri con supporto, ad incollo
 Shower door wiper, with glue
 Nettoyeur de douche, pour coller
 Glaswischer mit Wandhalterung aus verchromtem Messing zum Kleben
 Стеклоочиститель для стекла не более 10 мм

• 08 € 35,00



839

1078

Pulisci vetri con porta accappatoio singolo, per vetro da 10 mm max
 Shower door wiper, for glass of 10 mm maximum
 Nettoyeur de douche, pour un verre de 10 mm maximum
 Glaswischer mit Wandhalterung für Glas von maximal 10 mm
 Стеклоочиститель для стекла не более 10 мм

• 08 € 70,00



1078

985

Porta accappatoio doppio per vetro da 10 mm max
 Robe hook, for glass of 10 mm maximum
 Porte peignoir, pour un verre de 10 mm maximum
 Bademantelhaken, für Glas von maximal 10 mm
 Крючок для стекла не более 10 мм

• 08 € 70,00

• 16-25 € 89,00



985

964

Gancio porta accappatoio OTTONE
 Bathrobe hook BRASS
 Crochet pour peignoir BRASS
 Bademantelhaken BRASS
 Крючок для халата BRASS

cm 2 L x 5 P x 12 H

• 08 € 29,00

• 16-25 € 40,00



16

25



964



936 TR

936 BI

936 NE

936

Gancio porta accappatoio PLEXIGLASS
 Plexiglass bathrobe hook
 Crochet pour peignoir en plexiglas
 Bademantelhaken aus Plexiglas
 Крючок для халата из оргстекла

cm 2 L x 5 P x 12 H

• TR - BI - NE € 19,00

984

Porta accappatoio singolo
 per vetro da 10 mm max
 Robe hook, for glass of 10 mm maximum
 Porte peignoir, pour un verre de 10 mm max.
 Bademantelhaken, für Glas von maximal 10 mm
 Крючок для стекла не более 10 мм

cm 6 L x 8 P x 2 H

• 08 € 49,00

• 16-25 € 65,00



984

DOCCIA

1346

Pensile doccia rettangolare con
1 piano e 2 porta accappatoio
Rectangular structure for shower with
1 shelf and 2 robe-hook
Structure rectangulaire avec 1
plateaux et 2 porte peignoir
Korbgestell rechteckig mit 1 Ablagen, 2 Haken
Решётка 1-х уровневая + 2 крючка для
душевого угла
cm 31 L x 13,5 P x 35 H

• 08 - 23	€ 160,00
• 36	€ 195,00
• FN	€ 230,00



1347

Pensile doccia a parete
Double shelf for wall
Structure a mur avec 2 plateaux
Korbgestell , 2 Ablagen
Решётка в ванную 2-х уровневая
cm 26 L x 11 P x 52 H

• 08 - 23	€ 235,00
• 36	€ 290,00
• FN	€ 350,00



FN*

PROGETTO SARTORIA
Tailoring project
Finishes on request
finitions sur demande
Ausführungen auf Anfrage
отделка по запросу

DOCCIA

1348

Pensile doccia rettangolare con
2 piani e 2 porta accappatoio
Rectangular structure for shower with
2 shelves and 2 robe-hook
Structure rectangulaire avec 2
plateaux et 2 porte peignoir
Korbgestell rechteckig mit 2 Ablagen, 2 Haken
Решётка 2-х уровневая + 2 крючка для
душевого угла
cm 30 L x 13 P x 54 H

• 08 - 23	€ 235,00
• 36	€ 290,00
• FN	€ 340,00



1349

Pensile doccia rettangolare adatto a box
doccia con anta scorrevole, con 2 porta
accappatoio
Rectangular structure for shower with
2 shelves and robe-hook
Structure rectangulaire avec 2
plateaux et porte peignoir
Korbgestell für Dusche mit Schiebetüren,
rechteckig, mit 2 Haken für Bademäntel
Решётка 2-х уровневая +
крючок для душевого угла
cm 30 L x 12 P x 55 H

• 08 - 23	€ 295,00
• 36	€ 360,00
• FN	€ 430,00

Foto: versione sinistra
Photo: left version
Photo: version gauche
Auf dem Bild: linke Ausführung
Фото: Левый версия



FN*

PROGETTO SARTORIA
Tailoring project
Finishes on request
finitions sur demande
Ausführungen auf Anfrage
отделка по запросу

MM 1336

Porta oggetti per vasca inox 316
Stainless steel 316 bathtub organizer
Organisateur de baignoire en acier inoxydable 316
Badewannenorganizer aus Edelstahl 316
Органайзер для ванны из нержавеющей стали 316

cm 80 L x 15 P x 15 H

• 54	€ 140,00
• 24	€ 160,00



MM 1335

Mensola doccia inox 316
Stainless steel 316 shower shelf
Étagère de douche en acier inoxydable 316
Duschablage aus Edelstahl 316
Полка для душа из нержавеющей стали 316
cm 60 L x 12 P x 8 H

• 54	€ 170,00
• 24	€ 190,00

 Possibilità di fissaggio ad incollo
Possibility of installation by glue
Possibilité de fixation par colle
Befestigungsmöglichkeit mit Klebstoff
возможность крепления на клей



MM 1337

Angolo doccia 2 ganci inox 316
Stainless steel 316 shower corner with 2 hooks
Coin douche en acier inoxydable 316 avec 2 crochets

Duschecke aus Edelstahl 316 mit 2 Haken
Душевой уголок из нержавеющей стали 316 с 2 крючками

cm 29 L x 20 P x 9 H

• 54	€ 99,00
• 24	€ 120,00

 Possibilità di fissaggio ad incollo
Possibility of installation by glue
Possibilité de fixation par colle
Befestigungsmöglichkeit mit Klebstoff
возможность крепления на клей



840

Kit collante e biadesivo per un articolo
Kit with bi-adhesive and glue for one article
Kit avec collant et biadhésif pour un article
Klebekit ist ein beidseitiger Klebestreifen
Возможность установки на клей.Біфдгеш

•	€ 4,80
---	--------



DOCCIA

1087

Mensola in plexiglass ad angolo con balconcino
Shelf with plexyglass planeand balcony
Console avec plateau en Plexyglas et balconnet
Ablage aus klarem plexiglass mit Halteleiste
полка из оргстекла с ограничителем
cm 20 L x 20 P x 12,5 H

•08

€ 155,00



1089

Mensola in plexiglass con balconcino
Shelf with plexyglass planeand balcony
Console avec plateau en plexyglas et balconnet
Ablage aus klarem Plexyglas mit Halteleiste
полка из оргстекла с ограничителем
cm 26 L x 11 P x 12,5 H

•08

€ 155,00



1090

Mensola in plexiglass con balconcino
Shelf with plexyglass planeand balcony
Console avec plateau en Plexyglas et balconnet
Ablage aus klarem Plexiglass mit Halteleiste
полка из оргстекла с ограничителем
cm 40 L x 11 P x 12,5 H

•08

€ 170,00



DOCCIA

1046

Pensile doccia a parete
Double shelf for wall
Structure a mur avec 2 plateaux
Korbgestell , 2 Ablagen
Решётка в ванную 2-х уровневая
cm 26 L x 11 P x 52 H

•08

€ 270,00



1044

Pensile doccia per pannello fisso
Double shelf for glass shower
Structure avec 2 plateaux et 2 porte peignoir
Korbgestell mit 2 Ablagen, 2 Haken
Решётка 2-х + 2 крючка для душевого угла
cm 26 L x 11 P x 55 H

•08

€ 275,00



DOCCIA

1218

Mensola in plexiglass , fissaggio con viti
Shelf with plexiglass, screws fixing
Console avec plateau en plexiglass, fixation avec vis
Ablage aus klarem Plexiglass, Befestigung mit Schrauben
Оргстеклянная полка, крепление винтами
cm 25 L x 10 P x 7,5 H

• 08

€ 60,00



1219



Mensola in plexiglass, fissaggio con colla
Shelf with plexiglass, Glue fixing
Console avec plateau en plexiglass, fixation avec de la colle
Ablage aus klarem Plexiglass, Befestigung mit Klebstoff
Оргстеклянная полка, крепление клеем
cm 25 L x 10 P x 7,5 H

• 08

€ 80,00



DOCCIA

1172

Pensile doccia rettangolare con 2 piani e 2 porta accappatoio
Rectangular structure for shower with 2 shelves and 2 robe-hook
Structure rectangulaire avec 2 plateaux et 2 porte peignoir
Korbgestell rechteckig mit 2 Ablagen, 2 Haken
Решётка 2-х уровневая + 2 крючка для душевого угла
cm 25 L x 20 P x 72 H - MAX 8mm

• TR

€ 235,00



1171

Pensile doccia per box con anta scorrevole
Double shelf for glass shower with sliding doors
Structure avec 2 plateaux et porte peignoir
Korbgestell für Dusche mit Schiebetüren, rechteckig, mit 2 Haken für Bademäntel
Решётка 2-х + 2 крючка для душевого угла
cm 25 L x 20 P x 72 H

• TR

€ 295,00

Per ante scorrevoli (profilo cm 3,6 massimo)

For sliding doors (profile cm 4,5 maximum)
Pour porte coulissantes (profil cm 4,5 maximum)
Für Schiebetüren (Profil cm 4,5 maximal)
для раздвижных дверей
(максимальный профиль 4,5 см)



1220

Mensola in INOX 316, fissaggio con Viti
Shelf with INOX 316 screws fixing
Console avec plateau en INOX 316, fixation avec vis
Ablage aus klarem INOX 316, Befestigung mit Schrauben
Полка из нержавеющей стали 316, крепление винтами
cm 25 L x 10 P x 7,5 H

• 54	€ 72,00
• 23	€ 80,00



1221



Mensola in INOX 316, fissaggio con colla
INOX 316 shelf, fixing with glue
Etagère en ACIER INOXYDABLE 316, fixation avec de la colle
Ablage aus EDELSTAHL 316, Befestigung mit Klebstoff
Полка из нержавеющей стали 316, крепление клеем
cm 25 L x 10 P x 7,5 H

• 54	€ 89,00
• 23	€ 96,00



1223

Pensile doccia rettangolare con 2 piani e 2 porta accappatoio
Rectangular structure for shower with 2 shelves and 2 robe-hook
Structure rectangulaire avec 2 plateaux et 2 porte peignoir
Korbgestell rechteckig mit 2 Ablagen, 2 Haken
Решётка 2-х уровневая + 2 крючка для душевого угла
cm 25 L x 20 P x 72 H - MAX 8mm

• 54	€ 260,00
• 23	€ 290,00



1226

Pensile doccia per box con anta scorrevole
Double shelf for glass shower with sliding doors
Structure avec 2 plateaux et porte peignoir
Korbgestell für Dusche mit Schiebetüren, rechteckig, mit 2 Haken für Bademäntel
Решётка 2-х + 2 крючка для душевого угла
cm 25 L x 11 P x 60 H

• 54	€ 320,00
• 23	€ 340,00

**Per ante scorrevoli
(profilo cm 3,6 massimo)**

For sliding doors (profile cm 4,5 maximum)
Pour porte coulissantes (profil cm 4,5 maximum)
Für Schiebetüren (Profil cm 4,5 maximal)
для раздвижных дверей
(максимальный профиль 4,5 см)

DOCCIA

1254

Angolare in plexiglass , fissaggio con viti
Plexiglass corner, screw fixing
Angle en plexiglas, fixation par vis
Plexiglas-Ecke, Schraubbefestigung
Уголок из оргстекла, винтовое крепление
cm 31 L x 15 P x 7,5 H

• 08

€ 85,00



1255



Angolare in plexiglass, fissaggio con colla
Plexiglass corner, fixing with glue
Coin de plexiglas, fixation par colle
Plexiglas-Ecke, Befestigung mit Kleber
Уголок из оргстекла, крепление с помощью клея
cm 31 L x 15 P x 7,5 H

• 08

€ 105,00



DOCCIA

1256

Pensile doccia angolare con
2 piani e 2 porta accappatoio
Corner shower cabinet with 2 shelves and 2
bathrobe holders
Cabine de douche d'angle avec 2 étagères et 2
porte-peignoirs de bain
Eck-Duschkabine mit 2 Ablagen und 2 Bade-
mantelhaltern
Угловая душевая кабина с 2 полки и 2
держателя для халатов
cm 31 L x 20 P x 72 H - MAX 8mm

• TR

€ 275,00



1257

Pensile doccia angolare per box con anta
scorrevole
Corner shower wall unit for sliding door box
Colonne de douche d'angle pour cabine de
douche à porte coulissante
Eck-Duschwand für Schiebetürkasten
Угловой душевой настенный блок для бокса с
раздвижной дверью
cm 31 L x 20 P x 72 H

• TR

€ 355,00

Per ante scorrevoli (profilo cm 3,6 massimo)

For sliding doors (profile cm 4,5 maximum)
Pour porte coulissantes (profil cm 4,5 maximum)
Für Schiebetüren (Profil cm 4,5 maximal)
для раздвижных дверей
(максимальный профиль 4,5 см)

RACK Designer Markus Binz

1292

Angolare in INOX 316, fissaggio con viti
 Angle bracket made of INOX 316, screw fixing
 Support angulaire en acier inoxydable 316,
 fixation par vis
 Winkelkonsole aus Edelstahl 316, Schraubbe-
 festigung
 Угловой кронштейн из нержавеющей стали
 316, винтовое крепление
 cm 31 L x 15 P x 6 H

• 54	€ 82,00
• 23	€ 92,00



1293



Angolare in INOX 316, fissaggio con colla
 Angle made of INOX 316, fixing with glue
 Angle en INOX 316, fixation par collage
 Winkel aus INOX 316, Befestigung mit Klebstoff
 Угол из INOX 316, крепление с помощью клея
 cm 31 L x 15 P x 6 H

• 54	€ 99,00
• 23	€ 115,00



Designer Markus Binz RACK

1294

Pensile doccia angolare per box con anta fissa
 Corner shower enclosure with fixed door
 Colonne de douche d'angle pour porte fixe
 Eckduschwand für Kasten mit fester Tür
 Угловой душевой настенный блок для
 фиксированного дверного блока
 cm 31 L x 20 P x 72 H - MAX 8mm

• TR - 54	€ 278,00
• TR - 23	€ 298,00

1295

Pensile doccia angolare per box con anta
 scorrevole
 Corner shower wall unit for sliding door box
 Colonne de douche d'angle pour cabine de
 douche à porte coulissante
 Eck-Duschwand für Schiebetürkasten
 Угловой душевой настенный блок для бокса с
 раздвижной дверью
 cm 31 L x 20 P x 72 H

• TR - 54	€ 335,00
• TR - 23	€ 360,00

Per ante scorrevoli (profilo cm 3,6 massimo)

For sliding doors (profile cm 4,5 maximum)
 Pour porte coulissantes (profil cm 4,5 maximum)
 Für Schiebetüren (Profil cm 4,5 maximal)
 для раздвижных дверей
 (максимальный профиль 4,5 см)

DOCCIA

1296

Angolare in plexiglass con 2 ripiani
Plexiglass corner unit with 2 shelves
Unité d'angle en plexiglas avec 2 étagères
Plexiglas-Eckschrank mit 2 Fachböden
Угловой шкаф из оргстекла с 2 полками
cm 31 L x 15 P x 43 H

• TR € 250,00



1297

Angolare in INOX 316 con 2 ripiani
316 stainless steel corner unit with 2 shelves
Unité d'angle en acier inoxydable 316 avec 2 étagères
Eckschrank aus Edelstahl 316 mit 2 Einlegeböden
Угловой блок из нержавеющей стали 316 с 2 полками
cm 31 L x 15 P x 43 H

• TR - 54 € 250,00

• TR - 23 € 280,00



DOCCIA

1298

Pensile in plexiglass con 2 ripiani
Plexiglass wall unit with 2 shelves
Unité murale en plexiglas avec 2 étagères
Plexiglas-Wandschrank mit 2 Einlegeböden
Настенный шкаф из оргстекла с 2 полками
cm 26 L x 12 P x 43 H

• TR € 198,00



1299

Pensile in INOX 316 con 2 ripiani
INOX 316 wall unit with 2 shelves
Unité murale INOX 316 avec 2 étagères
Hängeschrank INOX 316 mit 2 Regalen
Настенный шкаф INOX 316 с 2 полками
cm 26 L x 12 P x 43 H

• TR - 54 € 230,00

• TR - 23 € 250,00



DOCCIA

785

Pensile doccia rettangolare con 2 piani e 2 porta accappatoio
Rectangular structure for shower with 2 shelves and 2 robe-hook
Structure rectangulaire avec 2 plateaux et 2 porte peignoir
Korbgestell rechteckig mit 2 Ablagen, 2 Haken
Решётка 2-х уровневая + 2 крючка для душевого угла
cm 25 L x 12P x 53 H

• 08 - 23

€ 180,00



DOCCIA

773

Pensile doccia rettangolare adatto a box doccia con anta scorrevole, con 2 porta accappatoio
Rectangular structure for shower with 2 shelves and robe-hook
Structure rectangulaire avec 2 plateaux et porte peignoir
Korbgestell für Dusche mit Schiebetüren, rechteckig, mit 2 Haken für Bademäntel
Решётка 2-х уровневая + крючок для душевого угла
cm 26 L x 55 H - P int. 12

• 08

€ 195,00

Foto: versione sinistra
Photo: left version
Photo: version gauche
Auf dem Bild: linke Ausführung
Фото: Левый версия

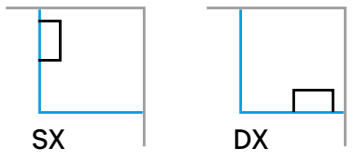

Per ante scorrevoli (profilo cm 6 massimo)

For sliding doors (profile cm 6 maximum)
Pour porte coulissantes (profil cm 6 maximum)
Für Schiebetüren (Profil cm 6 maximal)
для раздвижных дверей
(максимальный профиль 6 см)

Brevetto Europeo N. 272623
European Patent No. 272623
Brevet Européen No. 272623
Europäisches Patent Nr. 272623
Европейский патент No 272 623

DOCCIA

1071

Griglia porta spugna in ottone
Brass grill sponge holder
Grille porte éponge en laiton
Korbgestell, Schwammhalter aus Messing
Решётка в ванную

cm 34 L x 13,5 P x 7 H

• 08 - 23 € 160,00



Possibilità di fissaggio ad incollo
Possibility of installation by glue
Possibilité de fixation par colle
Befestigungsmöglichkeit mit Klebstoff
возможность крепления на клей



840

Kit collante e biadesivo per un articolo
Kit with bi-adhesive and glue for one article
Kit avec collant et biadhésif pour un article
Klebekit ist ein beidseitiger Klebestreifen
Возможность установки на клей.Б/фдреш

• € 4,80

1072

Pensile doccia rettangolare con
1 piano e 2 porta accappatoio
Rectangular structure for shower with
1 shelve and 2 robe-hook
Structure rectangulaire avec 1
plateaux et 2 porte peignoir
Korbgestell rechteckig mit 1 Ablagen, 2 Haken
Решётка 1-х уровневая + 2 крючка для
душевого угла

cm 31 L x 13,5 P x 35 H

• 08 - 23 € 275,00



DOCCIA

1300

Pensile doccia rettangolare con
2 piani e 2 porta accappatoio
Rectangular structure for shower with
2 shelves and 2 robe-hook
Structure rectangulaire avec 2
plateaux et 2 porte peignoir
Korbgestell rechteckig mit 2 Ablagen, 2 Haken
Решётка 2-х уровневая + 2 крючка для душевого угла

cm 30 L x 13 P x 54 H

• 08 - 23 € 460,00



1301

Pensile doccia rettangolare adatto a box
doccia con anta scorrevole, con 2 porta
accappatoio
Rectangular structure for shower with
2 shelves and robe-hook
Structure rectangulaire avec 2
plateaux et porte peignoir
Korbgestell für Dusche mit Schiebetüren,
rechteckig, mit 2 Haken für Bademäntel
Решётка 2-х уровневая +
крючок для душевого угла

cm 30 L x 12 P x 55 H

• 08 - 23 € 490,00

Foto: versione sinistra
Photo: left version
Photo: version gauche
Auf dem Bild: linke Ausführung
Фото: Левый версия



DOCCIA

D15

Griglia porta spugna in ottone
Brass grill sponge holder
Grille porte éponge en laiton
Korbgestell, Schwammhalter aus Messing
Решётка в ванную
cm 25 L x 12 P x 8 H

• 08 - 23	€ 72,00
• 16 - 25	€ 95,00



868

Griglia angolare per doccia
Brass grill for shower
Grille angulaire
Korbgestell eckig für Dusche
Решётка в ванную
cm 27 L x 27 P x 7 H

• 08	€ 125,00
------	----------



872

Griglia porta spugna in ottone
Brass grill sponge holder
Grille porte éponge en laiton
Korbgestell, Schwammhalter aus Messing
Решётка в ванную
cm 28,5 L x 12,5 P x 7 H

• 08	€ 120,00
------	----------



1007

Set per incollo con colla
Metal part for fixing with glue
Plaque métallique pour fixation avec colle
Blech eckig für zum Kleben links
Крепеж на клей
cm Ø5

• 08	€ 35,00
• 16 - 25	€ 48,00



DOCCIA

873

Griglia porta spugna in ottone
Brass grill sponge holder
Grille porte éponge en laiton
Korbgestell, Schwammhalter aus Messing
Решётка в ванную
cm 40 L x 12,5 P x 7 H

• 08	€ 130,00
------	----------



875

Griglia angolare in ottone per doccia
Brass corner grill for shower
Grille angulaire en laiton pour douche
Korbgestell eckig aus Messing für Dusche
Решётка в ванную
cm 29 L x 20 P x 6 H

• 08	€ 150,00
------	----------



874

Griglia angolare in ottone per doccia
Brass corner grill for shower
Grille angulaire en laiton pour douche
Korbgestell eckig aus Messing für Dusche
Решётка в ванную
cm 26 L x 18 P x 6 H

• 08	€ 140,00
------	----------



DOCCIA

571

Griglia angolare in ottone per doccia
Brass corner grill for shower
Grille angulaire en laiton pour douche
Korbgestell eckig aus Messing für Dusche
Решётка в ванную
cm 21 L x 12 P x 5 H

• 08	€ 72,00
• 23	€ 77,00
• 16 - 25	€ 98,00



952

Griglia angolare in ottone
Brass corner grill
Grille angulaire en laiton
Korbgestell eckig aus Messing
Решётка в ванную
cm 29 L x 20 P x 7 H

• 08	€ 82,00
------	---------



570

Griglia angolare in ottone con 2 ripiani
Brass corner grill with 2 shelves
Grille angulaire en laiton avec 2 plateaux
Korbgestell eckig aus Messing mit 2 Ablagen
Решётка в ванную 2-х уровневая
cm 20 L x 12 P x 29 H

• 08	€ 120,00
• 23	€ 130,00
• 16 - 25	€ 150,00



DOCCIA

569

Griglia angolare in ottone con 3 ripiani
Brass corner grill with 3 shelves
Grille angulaire en laiton avec 3 plateaux
Korbgestell eckig aus Messing mit 3 Ablagen
Решётка в ванную 3-х уровневая
cm 20 L x 12 P x 54 H

• 08	€ 175,00
• 23	€ 185,00
• 16 - 25	€ 230,00



16



23



25



879

Griglia angolare in ottone con 2 ripiani
Brass corner grill with 2 shelves
Grille angulaire en laiton avec 2 plateaux
Korbgestell eckig aus Messing mit 2 Ablagen
Решётка в ванную 2-х уровневая
cm 30 L x 20 P x 34 H

• 08	€ 175,00
------	----------



1007

Set per incollo con colla
Metal part for fixing with glue
Plaque métallique pour fixation avec colle
Blech eckig für zum Kleben links
Крепеж на клей
cm Ø5

• 08	€ 35,00
• 16 - 25	€ 48,00



DOCCIA

G 693 GIUNONE

Angolare in ottone con 3 ripiani in Vedril
Wall mounted corner brass with 3 Vedril shelves
Angulaire en laiton avec 3 plateaux en Vedril
Gestell eckig aus Messing mit 3 Ablagen aus Vedril
Решётка 3-х уровневая в ванную

cm 22 L x 13 P x 45 H

• 08	€ 250,00
• 02	€ 270,00
• 16 - 25 - 26 - 36	€ 340,00



EL 31 ELITE

Angolare in ottone con 3 ripiani in Vedril
Wall mounted corner brass with 3 Vedril shelves
Angulaire en laiton avec 3 plateaux en Vedril
Gestell eckig aus Messing mit 3 Ablagen aus Vedril
Решётка 3-х уровневая в ванную

cm 22 L x 13 P x 45 H

• 08	€ 230,00
• 02	€ 260,00
• 16 - 25 - 26 - 36	€ 310,00



DOCCIA

048

Struttura angolare sospesa in ottone con due ripiani in Vedril e 2 ganci
Wall mounted corner brass structure with 2 Vedril shelves and 2 hooks

Structure à angle suspendue en laiton avec 2 plateaux en Vedril et 2 crochets
Gestell eckig aus Messing mit 2 Ablagen aus Vedril und 2 Haken

Решётка 2-х уровневая + 2 крючка в ванную

cm 22 L x 13 P x 40 H

• 08	€ 110,00
------	----------



844

Mensola da 8 mm con balconcino
Shelf 8 mm with balcony

Console de 8 mm et balconnet

Ablage aus 8 mm mit Halteleiste

Стеклянная полка с ограждением - толщина стекла 8 мм

cm 35 L x 25 P x 5 H

• 08	€ 105,00
------	----------



Z 04

Mensola da 8mm

Shelf 8mm

Console 8mm

Ablage 8 mm

Стеклянная полка - толщина стекла 8 мм

cm 60 L x 12 P x 2 H

• 08	€ 58,00
------	---------

Su misura

on measure / sur mesure / maßgeschneiderte / настронли

• 08 - cm 30/59 € 70,00

• 08 - cm 61/100 € 82,00



PENSILI E MENSOLE

EL 694 ELITE

Struttura rettangolare sospesa in ottone con 2 ripiani in cristallo 5 mm
 Wall mounted rectangular brass structure with 2 crystal glass shelves 5 mm
 Structure rectangulaire suspendue en laiton avec 2 plateaux en cristal 5 mm
 Gestell rechteckig aus Messing mit 2 Ablagen aus Kristallglas 5 mm
 Стеклопанельная полка 2-х уровневая с ограждением см 45 L x 15 P x 38 H

• 08	€ 390,00
• 02	€ 410,00
• 16 - 25 - 26 - 36	€ 520,00



G 694 GIUNONE

Struttura rettangolare sospesa in ottone con 2 ripiani in cristallo 5 mm
 Wall mounted rectangular brass structure with 2 crystal glass shelves 5 mm
 Structure rectangulaire suspendue en laiton avec 2 plateaux en cristal 5 mm
 Gestell rechteckig aus Messing mit 2 Ablagen aus Kristallglas 5 mm
 Стеклопанельная полка 2-ух уровневая с ограждением см 45 L x 15 P x 38 H

• 08	€ 400,00
• 02	€ 430,00
• 16 - 25 - 26 - 36	€ 520,00



766 SMART

Mensola da 8 mm e balconcino
 Shelf with 8 mm crystal glass plane and balcony
 Console avec plateau en cristal de 8 mm et balconnet
 Ablage aus klarem Kristallglas 8 mm mit Halteleiste
 Стеклопанельная полка с ограждением - толщина стекла 8 мм

• 08 - cm 40 L x 14 P x 7 H	€ 130,00
• 08 - cm 30 L x 14 P x 7 H	€ 125,00



819 MEDEA

Mensola da 8 mm con balconcino
 Shelf with 8 mm crystal glass plane and balcony
 Console avec plateau en cristal de 8 mm et balconnet
 Ablage aus klarem Kristallglas 8 mm mit Halteleiste
 Стеклопанельная полка с ограждением - толщина стекла 8 мм

• 08 - cm 40 L x 14 P x 7 H	€ 140,00
• 08 - cm 30 L x 14 P x 7 H	€ 130,00



820 URANIA

Mensola da 8 mm con balconcino
 Shelf with 8 mm crystal glass plane and balcony
 Console avec plateau en cristal de 8 mm et balconnet
 Ablage aus klarem Kristallglas 8 mm mit Halteleiste
 Стеклопанельная полка с ограждением - толщина стекла 8 мм

• 08 - cm 40 L x 14 P x 7 H	€ 160,00
• 08 - cm 30 L x 14 P x 7 H	€ 155,00

SGABELLI

997

Sgabello contenitore inox 304 con ecopelle
Stainless steel and ecoleather container for lingerie
Container pour linge inox et faux cuir
Edelstahl-Wäschekorb
корзина для белья на стене
cm 32 L x 32 P x 52 H

• 55	€ 260,00
• 24 - 23	€ 295,00
• 96 - 27	€ 390,00



997 - 55



997 - 24



997 - 23



SGABELLI

638

Sgabello con 4 gambe
Stool with 4 legs
Tabouret avec 4 jambes
Hocker mit 4 Beinen
Стул на 4-х ножках
cm Ø 37 x 39 H

• 01	€ 70,00
------	---------

Kg 100 Carico statico
Static load/Charge statique/Statische Belastung/
статическая нагрузка
CE norma MDD 93/42



638



650

650

Sgabello con 4 gambe
Stool with 4 legs
Tabouret avec 4 jambes
Hocker mit 4 Beinen
Стул на 4-х ножках
cm Ø 36 x 40 H

• 08	€ 89,00
------	---------

Kg 110 Carico statico
Static load/Charge statique/Statische Belastung/
статическая нагрузка
CE norma MDD 93/42



1137/TR



1137/01



1137/23

1137

Sgabello plexiglass
Plexiglass stool
Tabouret en plexiglas
Hocker mit Plexiglas
оргстекло стул
cm 28 L x 25 P x 44 H

• TR	€ 245,00
• 01 - 23	€ 265,00

Kg 110 Carico statico
Static load/Charge statique/Statische Belastung/
статическая нагрузка

Certificato - UNI EN 14183

979

Sgabello plexiglass
Plexiglass stool
Tabouret en plexiglas
Hocker mit Plexiglas
оргстекло стул
cm 28 L x 28 P x 44 H

• 08	€ 275,00
------	----------



979

994

Cestino con coperchio
ELITE / MARTE / IDRA
Dustbin with cover
Panier avec couverture
Korb mit Deckel
Контейнер для мусора
cm Ø 21 x 25 H

• 08	€ 260,00
• 16 - 25	€ 360,00

994

Cestino con coperchio
PRISMA / NEMI / NOTO / NOTO LIGHT
Dustbin with cover
Panier avec couverture
Korb mit Deckel
Контейнер для мусора
cm Ø 21 x 25 H

• 08	€ 280,00
• 16 - 25	€ 380,00



994 NE



994 EL



994 MA



994 PR



1199

Sgabello plexiglass con getta rifiuti inox 304
Plexiglass stool with stainless steel 304 waste disposal
Tabouret en plexiglas avec élimination des déchets en acier inoxydable 304
Hocker aus Plexiglas mit Abfallentsorgung aus Edelstahl 304
Стул из оргстекла с утилизацией отходов из нержавеющей стали 304
cm 28 L x 25 P x 44 H

• 01 - 23	€ 370,00
-----------	----------



1199 - 01



1199 - 23



HOTELLERIE

Designer: STHILHAUS

Fuori misura: no

Customized: no

Personnalisé: non

Kundenwunsch: nein

Негабаритный: нет

**VE 04**

Mensola con piano in vetro trasparente 8 mm
Shelf with transparent glass plane 8 mm
Etagère avec plan en verre transparent 8 mm
Ablage aus klarem Glas 8 mm
Стеклоплатформа - толщина стекла 8 мм
cm 60 L x 12 P x 5 H

•08

€ 78,00



Possibilità di fissaggio ad incollo / Possibility of installation by glue / Possibilité de fixation par colle / Befestigungsmöglichkeit mit Klebstoff / возможность крепления на клей

**LZ 05**

Asta porta asciugamani
Towel rail
Porte serviette
Handtuchhalter
Полотенцедержатель
cm 61 L x 7 P x 5 H

•08

€ 65,00

**LZ 05.2**

Porta asciugamani doppia asta
Towel rail 2 bars
Porte serviette avec 2 bar
Doppel-Handtuchstange
полотенцедержатель двойной
cm 65 L x 11 P x 5 H

•08

€ 99,00



Possibilità di fissaggio ad incollo / Possibility of installation by glue / Possibilité de fixation par colle / Befestigungsmöglichkeit mit Klebstoff / возможность крепления на клей

**LZ 10 M**

Porta bicchiere in ottone
Brass glass holder
Porte verre en laiton
Zahnbürstenhalter aus Messing
Настенный металлический стакан
cm 7 L x 11 P x 11 H

•08

€ 65,00

**LZ 30 V**

Porta dosatore sapone liquido
Wall-mounted liquid soap dispenser
Doseur de savon liquid
Seifenspender
Настенный стеклянный дозатор для мыла
cm 5 L x 9 P x 18 H

•08

€ 77,00

**LZ 11**

Porta rotolo
Paper holder
Porte rouleau
Papierrollenhalter
Настенный бумагодержатель
cm 17 L x 7 P x 4,5 H

•08

€ 39,00

**LZ 45**

Asta porta asciugamani
Towel rail
Porte serviette
Handtuchhalter
Полотенцедержатель
cm 50 L x 7 P x 5 H

•08

€ 62,00

**LZ 06**

Asta porta salviette
Serviette holder
Porte serviettes
Handtuchhalter
Полотенцедержатель
cm 36 L x 7 P x 5 H

•08

€ 59,00

**LZ 07**

Anello porta salviette
Serviette holder to ring shaped
Porte serviettes à anneau
Handtuchring
Полотенцедержатель - кольцо
cm 23 Ø x 5 P x 26 H

•08

€ 55,00

**LZ 11 S**

Porta rotolo di scorta
Paper holder of supply
Porte rouleau d'escorte
Ersatzpapierrollenhalter
Вертикальный бумагодержатель
cm 5 L x 7 P x 17 H

•08

€ 59,00

**1167**

Porta rotolo di scorta
Spare roll holder
Porte-rouleau de rechange
Ersatz-Rollenhalter
Держатель запасного валика
cm 10 L x 2,5 P x 14 H

•08

€ 49,00

**LZ 11C**

Porta rotolo con coperchio
Covered paper holder
Porte rouleau avec couvercle
Papierrollenhalter mit Deckel
Настенный бумагодержатель закрытый
cm 14 L x 12 P x 13 H

•08

€ 79,00

**LZ 09 V**

Porta sapone in vetro
Glass soap dish
Porte savon en verre
Seifenschale aus Glas
Настенная стеклянная мыльница
cm 12 L x 12 P x 8 H

•08

€ 49,00

**LZ 09 M**

Porta sapone in ottone
Brass soap dish
Porte savon en laiton
Seifenschale aus Messing
Настенная металлическая мыльница
cm 12 L x 8 P x 9 H

•08

€ 65,00

**LZ 10 V**

Porta bicchiere in vetro
Glass holder
Porte verre en verre
Zahnbürstenhalter aus Glas
Настенный стеклянный стакан
cm 7 L x 10 P x 9 H

•08

€ 49,00

**LZ 11.2**

Porta rotolo doppio
Paper holder of supply
Porte rouleau d'escorte
Doppel - Papierrollenhalter
Настенный бумагодержатель двойной
cm 25,5 L x 7 P x 5 H

•08

€ 79,00

**1005**

Porta rotolo INOX coperto
INOX covered paper holder
Porte rouleau avec couvercle en INOX
Papierrollenhalter INOX mit Deckel
Настенный бумагодержатель закрытый
cm 12 L x 13 P x 6 H

•08

€ 38,00

**LZ 809**

Porta accappatoio (2 ganci)
Robe hook (2 hooks)
Porte peignoir (2 crochets)
Bademantelhaken (2 Haken)
Крючок
cm 5,5 L x 5,5 P x 5,5 H

•08

€ 36,00

**VE 13/1**

Porta accappatoio (1 gancio)
Robe hook (1 hook)
Porte peignoir (1 crochet)
Bademantelhaken (1 Haken)
Ключок
cm 1 L x 4 P x 1 H

•08

€ 20,00

**VE 13/3**

Porta accappatoio (3 ganci)
Robe hook (3 hooks)
Porte peignoir (3 crochets)
Bademantelhaken (3 Haken)
Ключок тройной
cm 15 L x 4,5 P x 2 H

•08

€ 60,00

**LZ 039**

Porta scopino in ottone
Brass toilet-brush
Porte balayent en laiton
Bürstengarnitur aus Messing
Напольный
cm 8 Ø x 42 H

•08

€ 84,00

**748**

Griglia portasciugamani con 6 aste
Towel holder grill with 6 bars
Grille porte serviettes avec 6 barres
Badetuchablage mit Handtuchhalter 6 Stangen
Решётка для полотенец - 6 прутьев
cm 48 L x 28 P x 10 H

•08

€ 175,00

•23

€ 190,00

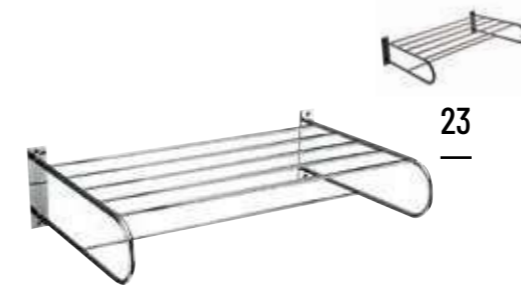

23

786

Griglia portasciugamani con 6 aste
Towel holder grill with 6 bars
Grille porte serviettes avec 6 barres
Badetuchablage mit Handtuchhalter 6 Stangen
Решётка для полотенец - 6 прутьев
cm 54 L x 28 P x 11 H

•08

€ 195,00

•23

€ 210,00



23

1236

Griglia portasciugamani con 6 aste
Towel holder grill with 6 bars
Grille porte serviettes avec 6 barres
Badetuchablage mit Handtuchhalter 6 Stangen
Решётка для полотенец - 6 прутьев
cm 63 L x 30 P x 10 H

•08

€ 149,00

HQC

**LZ 039 M**

Porta scopino a parete
Wall mounted toilet-brush
Porte balayent à mur
Bürstengarnitur wandhängend
Настенный металлический ёрш
cm 8 Ø x 42 H

•08

€ 92,00

**1215**

Porta scopino INOX 304
Brass toilet-brush
Porte balayent en laiton
Bürstengarnitur aus Messing
Напольный
cm 8 Ø x 42 H

•55

€ 55,00

**1215 M**

Porta scopino a parete INOX 304
Wall mounted toilet-brush
Porte balayent à mur
Bürstengarnitur wandhängend
Настенный металлический ёрш
cm 8 Ø x 42 H

•55

€ 85,00

**493**

Distributore asciugamani di carta in acciaio inox 304
Stainless steel distributor paper towels
Distributif serviettes de papier en acier inox
Papierhandtuchspender aus Edelstahl
Ящик для бумажных полотенец
cm 25 L x 12 P x 42 H

•55

€ 165,00

•23

€ 176,00

•16 - 18

€ 280,00



23

981

Distributore fazzoletti carta inox
Distributor handkerchiefs paper inox
Distributif mouchoirs papier inox
Spender für Kosmetiktücher inox
Ящик для листовой бумаги inox
cm 26 L x 12 P x 10 H

•55

€ 110,00

•23

€ 120,00

•16 - 18

€ 195,00

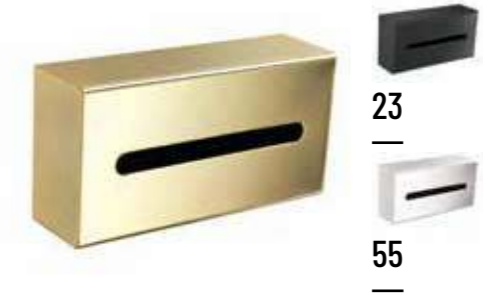

23

55

981 INC

Distributore fazzoletti carta da incasso
Paper handkerchief dispenser
Distributeur de mouchoirs en papier
Spender für Papiertaschentücher
Дозатор бумажных носовых платков
cm 26 L x 12 P x 10 H

•55

€ 99,00

**1216**

Porta scopino INOX 304
Brass toilet-brush
Porte balayent en laiton
Bürstengarnitur aus Messing
Напольный
cm 8 L x 8 P x 41 H

•55

€ 89,00

**1216 M**

Porta scopino a parete INOX 304
Wall mounted toilet-brush
Porte balayent à mur
Bürstengarnitur wandhängend
Настенный металлический ёрш
cm 8 L x 8 P x 41 H

•55

€ 118,00

**995 08**

Porta scopino in ABS
ABS toilet brush
Porte balayent en ABS
Bürstengarnitur aus ABS
Напольный АБС
cm Ø 9 x 43 H

•08

€ 45,00

**1122**

Distributore fazzoletti carta inox
Distributor handkerchiefs paper inox
Distributif mouchoirs papier inox
Spender für Kosmetiktücher inox
Ящик для листовой бумаги inox
cm 14 L x 12,5 P x 13 H

•55

€ 66,00

•23

€ 75,00

•16 - 18

€ 135,00



23

16 / 18

K 27

Distributore sacchetti igienici ABS
Sanitary bags dispenser
Distributif sachets hygiénique
Hygienebeutel Spender
Дозатор для гигиенических пакетов
cm 13 L x 5 P x 29 H

•08

€ 28,00

**K 24**

Distributore fazzoletti carta ABS
Distributor handkerchiefs paper ABS
Distributif mouchoirs papier ABS
Spender für Kosmetiktücher ABS
Ящик для листовой бумаги ABS
cm 26 L x 12 P x 5 H

•08

€ 72,00





K 19

Distributore asciugamani, fogli carta C o rotoli
Distributor towels in sheets paper C and rolls
Distributif serviettes, papier C or tu rouleaux
Papierhandtuchspender für C-Falz Handtücher oder Rollen
Ящик для гигиенической рулонной бумаги
cm 30 L x 19,5 P x 25 H

• 01 € 78,00



494

Distributore sapone liquido in ABS
ABS distributor liquid soap
Distributif de savon liquide en ABS
Seifenspender aus ABS
Дозатор для мыла - литра
cm 10 L x 8 P x 25 H

• 08 € 75,00



K 48

Distributore automatico di sapone / gel igienizzante
Automatic soap dispenser / hygiene gel
Distributeur automatique de savon / gel d'hygiène
Automatischer Seifenspender / Hygienegel
Автоматический дозатор мыла / гигиенический гель
cm 9 L x 9,5 P x 20 H • 0,5 lt

• 01 € 89,00

482



495

Distributore sapone liquido (Lt.1,2) in acciaio inox
Stainless steel distributor liquid soap (Lt.1,2)
Distributif de savon liquide (Lt.1,2) en acier inox
Seifenspender (Lt.1,2) aus Edelstahl
Дозатор для мыла - 1,2 литра
cm 10 L x 10,5 P x 27 H

• 55 € 195,00
• 23 € 215,00
• 16-18 € 280,00



K 32

Distributore sapone liquido (Lt.0,17) in ABS
ABS distributor liquid soap (Lt.0,17)
Distributif de savon liquide (Lt.0,17) en ABS
Seifenspender (Lt.0,17) aus ABS
Дозатор для мыла - 0,17 литра
cm 5,5 L x 7 P x 14 H

• 08 € 70,00



925

Distributore carta igienica misto in acciaio inox
Stainless steel distributor hygienic paper in sheets
Distributif papier hygiénique feuilles en acier inox
Toilettenpapierspender für Einzelblatt Entnahme aus Edelstahl
Ящик для бумажных полотенец в листах
cm 13 L x 11 P x 30 H

• 55 € 144,00
• 23 € 169,00
• 16-18 € 240,00

23



921

Distributore sapone liquido (Lt.0,8) in acciaio inox
Stainless steel distributor liquid soap (Lt.0,8)
Distributif de savon liquide (Lt.0,8) en acier inox
Seifenspender (Lt.0,8) aus Edelstahl
Дозатор для мыла - 0,8 литра
cm 9 L x 8 P x 19 H

• 55 € 98,00



K 22

Distributore sapone liquido (Lt.1,2)
Distributor liquid soap (Lt.1,2)
Distributif de savon liquide (Lt.1,2)
Seifenspender (Lt.1,2)
Дозатор для мыла
cm 13 L x 10 P x 23 H

• 01 € 65,00



K 45

Distributore carta igienica con doppio rotolo in acciaio INOX 304
Toilet paper dispenser with double roll in stainless steel 304
Distributeur de papier hygiénique avec double rouleau en acier inoxydable inox 304
Toilettenpapierspender mit Doppelrolle aus Edelstahl Inox 304
Дозатор туалетной бумаги с двойным рулоном из нержавеющей стали 304
cm 31 Ø x 13 P

• 55 € 120,00



K 23

Distributore carta igienica
Distributor hygienic paper
Distributif papier hygiénique
Toilettenpapierspender
Ящик для гигиенической бумаги
cm Ø 19 x 12 P

• 01 € 49,00



K 26

Filo stendi biancheria
Retractable clothes line
Fil étendoir
Wäscheleine
Выдвижная бельевая верёвка
cm 9 Ø x 5/200 L

• 55 € 46,00



DV 14 AP

Vaschetta porta oggetti
Tray plateau tablet
Tablet
Tablet
Настольный керамический лоток
cm 20 L x 10 P x 2 H

• 08 € 29,00

483



K 27 INOX

Distributore sacchetti igienici INOX 304
Sanitary bags dispenser
Distributif sachets hygiénique
Hygienebeutel Spender
Дозатор для гигиенических пакетов
cm 10 L x 2,5 P x 14 H

• 55 € 54,00
• 23 € 68,00



K 25

Distributore di carta copriwater INOX 304
STAINLESS STEEL 304 toilet paper dispenser
Distributeur de papier toilette en ACIER INOXYDABLE 304
Toilettenpapierspender aus EDELSTAHL 304
дозатор туалетной бумаги STAINLESS STEEL 304
cm 22,5 L x 4,5 P x 30 H

• 55 € 105,00
• 23 € 118,00



1059

Vaschetta di cortesia inox
Storage tray inox
Tablet
Tablet
Лоток для туалетных принадлежностей
cm 20 L x 12 P x 3 H

• 55 € 49,00

483



23

23



1309

Dispenser carta igienica misto
Dispenser carta igienica misto
Distributeur carta igienica misto
Spender carta igienica misto
Диспенсер carta igienica misto
cm 14 L x 15 P x 11 H

• 55 € 115,00
• 23 € 125,00



496

Distributore carta igienica in acciaio inox 304
Stainless steel distributor hygienic paper
Distributif papier hygiénique en acier inox
Toilettenpapierspender aus Edelstahl
Ящик для бумажных полотенец
cm 31 Ø x 13 P

• 55 € 185,00
• 23 € 198,00



23

1333

Poggia piedi in acciaio lucido
Polished steel footrest
Repose-pieds en acier poli
Fußstütze aus poliertem Stahl
Подставка для ног из полированной стали
cm Ø 25

• 55 € 59,00

483

**K 50**

Asciugamani a lama d'aria senza resistenza
Air knife hand dryers without resistance
Air knife hand dryers without resistance
Luftmesser-Händetrockner ohne Widerstand
Сушилки для рук с воздушным ножом без сопротивления
cm 22 L x 16 P x 28 H
CE: V 220 - 240 W 1100

• 01 ABS	€ 390,00
• 08	€ 590,00

**01 ABS****K 46**

Asciugamani elettrico JET - Led con raggi UV / Resistenza elettrica disattivabile / Motore AC a 2 velocità / Attivazione automatica con sensore
Towels electrical worker with photoelectric cell Serviettes électrique avec photocellule
Automatischer Handtrockner
Сушилка для рук
cm 30 L x 22 P x 68 H
CE: V 220-240 W 1900 IP 34

• 08	€ 1.100,00
------	------------

**K 40**

Asciugacapelli elettrico a parete
Wall-mounted electrical hairdryer
Séchè-cheveux électrique à mur
Elektrischer Wandhaartrockner
Электрический фен
cm 25 L x 14 P x 23,5 H
CE: V 230 W 1800 IP 24

€ 115,00

K52

Asciugacapelli elettrico per uso professionale con avviamento a pulsante
Wall-mounted electrical hairdryer with push button starter
Séchè-cheveux électrique à mur démarrage avec bouton
Elektrischer Wandhaartrockner mit Start-Taste
Электрический фен
cm 11 L x 21 H
CE: V 220 W 1800 IP 24

• 01	€ 149,00
• 23	€ 149,00

**K 41**

Contenitore per rifiuti ABS (25 lt)
ABS refusals container(25 lt)
Containeur pour refus en ABS (25 lt)
Abfalleimer aus ABS (25 lt)
Контейнер для ABS (25 lt)
cm 35 L x 27 P x 48 H

• 01	€ 49,00
------	---------

K 39

Asciugamani elettrico con fotocellula INOX 304
Towels electrical worker with photoelectric cell INOX 304
Serviettes électrique avec photocellule INOX 304
Automatischer Handtrockner INOX 304
Сушилка для рук
cm 31 L x 27 P x 25 H
CE: V 220 W 2500 IP 24

• 55	€ 550,00
------	----------

**K 49**

Asciugacapelli elettrico a parete Inox 304 e ABS
Wall-mounted electrical hairdryer
Séchè-cheveux électrique à mur
Elektrischer Wandhaartrockner
Электрический фен стены Inox 304 и ABS
cm 22 L x 11 H x 26 H
CE: V 220 - 240 W 1300 IP 21

€ 165,00

**987**

Contenitore per rifiuti inox (12 lt)
Stainless steel refusals container(12 lt)
Containeur pour refus en acier inox (12 lt)
Abfalleimer aus Edelstahl (12 lt)
Контейнер для мусора (12 lt)
cm Ø 23 x 28 H

• 55	€ 75,00
------	---------

**478.3LT**

Contenitore per rifiuti inox con pedale
Stainless steel refusals container with pedal
Containeur pour refus en acier inox avec pédale
Abfalleimer aus Edelstahl mit Fußpedal
Контейнер для мусора с педалью
cm Ø 17 x 25 H

• 55	€ 39,00
• 27 - 16	€ 160,00

**803.3L QUADRO**

Contenitore (3lt.) per rifiuti inox con pedale
Stainless steel refusals container (3 Lt.) with pedal
Containeur (3Lt.) pour refus inox avec pédale
Abfalleimer (3Lt.) aus Edelstahl mit Fußpedal
Квадратный контейнер для мусора
cm 16 L x 16 P x 24,5 H

• 55	€ 49,00
------	---------

**1165**

Cesto quadrato INOX 304 con coperchio basculante (8Lt)
STAINLESS STEEL 304 square basket with tilting lid (8Lt)
Panier carré en acier inoxydable 304 avec couvercle basculant (8Lt)
Viereckiger Korb aus Edelstahl 304 mit kippbarem Deckel (8Lt)
Нержавеющая сталь 304 квадратная корзина с откидной крышкой (8 литров)
cm 19 L x 19 P x 29 H

• 55	€ 178,00
• 23	€ 220,00

**25****16****HQC****478.5LT**

Contenitore per rifiuti inox con pedale
Stainless steel refusals container with pedal
Containeur pour refus en acier inox avec pédale
Abfalleimer aus Edelstahl mit Fußpedal
Контейнер для мусора с педалью
cm Ø 21 x 29 H

• 55	€ 49,00
• 23	€ 59,00
• 25 - 16	€ 175,00

**478.12**

Contenitore per rifiuti inox con pedale (12 lt)
Stainless steel refusals container with pedal (12 lt)
Containeur pour refus en acier inox avec pédale (12 lt)
Abfalleimer aus Edelstahl mit Fußpedal (12 lt)
Контейнер для мусора с педалью (12 lt)
cm Ø 25 x 40 H

• 55	€ 81,00
------	---------

**1166**

Cesto quadrato INOX 304 (8Lt)
STAINLESS STEEL 304 square basket (8Lt)
Panier carré en ACIER INOXYDABLE 304 (8Lt)
Korb aus rostfreiem Stahl 304 quadratisch (8Lt)
БЕСШВЕЙНАЯ СТАЛЬ 304 квадратная корзина (8 литров)
cm 19 L x 19 P x 29 H

• 55	€ 96,00
• 23	€ 125,00

HQC**1310.5LT CHIUSURA SILENZIOSA**

Contenitore (5lt.) per rifiuti inox con pedale
Stainless steel refusals container (5 Lt.) with pedal
Containeur (5Lt.) pour refus inox avec pédale
Abfalleimer (5Lt.) aus Edelstahl mit Fußpedal
Овальный контейнер для мусора
cm 19 L x 14,3 P x 26,5 H

• 55	€ 68,00
• 54	€ 72,00

**1327**

Cesto quadrato INOX 304 con coperchio basculante (9Lt)
STAINLESS STEEL 304 square basket with tilting lid (9Lt)
Panier carré en acier inoxydable 304 avec couvercle basculant (9Lt)
Viereckiger Korb aus Edelstahl 304 mit kippbarem Deckel (9Lt)
Нержавеющая сталь 304 квадратная корзина с откидной крышкой (9 литров)
cm Ø 20 x 30 H

• 55	€ 165,00
------	----------

**55 inox lucido**

**K 01**

Specchio basculante con vetro antinfortunistica
Adjustable mirror with accident-prevention glass
Mirror basculant avec verre anti prévention des accidents
Bewegbarer Spiegel aus Sicherheitsglas
Навесное зеркало с защитным стеклом
cm 61 L x 70 x H 7P

• 01 € 220,00

**K 01.02**

Specchio con vetro antinfortunistica
Mirror with accident-prevention glass
Mirror avec verre anti prévention des accidents
Spiegel aus Sicherheitsglas
Зеркало с защитным стеклом
cm 60 L x 90 H x H 7P

• 01 € 185,00

**K 02 INOX**

Corrimano di sicurezza orizzontale in acciaio lucido
Horizontal emergency handle en stell
Poignée de sûreté horizontale en acier inox
Bad Sicherheitsgriff aus beschichtetem Stahl
Горизонтальные поручни из полированной стали

• K 02.01.08 - cm 38 € 79,00
• K 02.02.08 - cm 49 € 90,00
• K 02.03.08 - cm 54 € 110,00
• K 02.05.08 - cm 69 € 125,00
• K 02.04.08 - cm 84 € 159,00

**K 02**

Corrimano di sicurezza orizzontale in acciaio verniciato
Horizontal emergency handle en stell-clad
Poignée de sûreté horizontale en acier inox
Bad Sicherheitsgriff aus beschichtetem Stahl
Горизонтальный поручень

• K 02.01 - cm 30 € 45,00
• K 02.02 - cm 38 € 55,00
• K 02.03 - cm 54 € 68,00
• K 02.04 - cm 80 € 79,00
• K 02.05 - cm 98 € 89,00
• K 02.06 - cm 130 € 98,00

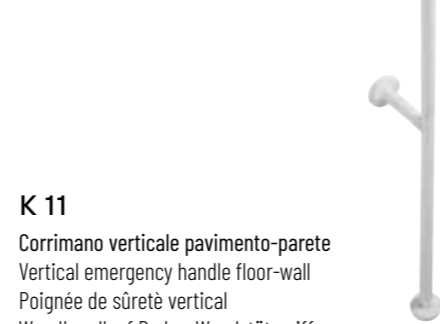
**K 11**

Corrimano verticale pavimento-parete
Vertical emergency handle floor-wall
Poignée de sûreté vertical
Wandhandlauf Boden-Wandstützgriff
Вертикальный поручень
cm 8 L x 17 P x 180 H

• 01 € 200,00

**K 07**

Impugnatura di sostegno ribaltabile
Rotary support handle en stell-clad
Poigne de soutien tournant en acier inox
Stützklappgriff
Складная ручка
cm 10 L x 60 P x 21 H

• 01 € 179,00

Con dispositivo di bloccaggio in posizione verticale.
With blocking device in vertical position
Avec dispositif de blocage en position verticale
Mit Sperre in die senkrechte Position
Крепеж на клей

**K 54**

Porta rotolo per impugnatura ribaltabile
Roll holder with foldable handle
Porte-rouleau avec poignée rabattable
Rollenhalter mit klappbarem Griff
Держатель рулона с откидной ручкой
cm 3,3 L x 17,5 P x 15,5 H

• 01 € 54,00

Con dispositivo di bloccaggio in posizione verticale.
With blocking device in vertical position
Avec dispositif de blocage en position verticale
Mit Sperre in die senkrechte Position
Крепеж на клей

**K 06**

Impugnatura di sostegno fissa
Fixed support handle
Poigne de soutien fixe
Bad Haltestange
Поручень правосторонний
cm 23 L x 80 P x 24 H

• 01 € 250,00

Con rinforzo sinistro
With left reinforce/ Avec je renforce gauche
Mit Verstärkung links/ с фиксацией слева

• 01 € 250,00

Con rinforzo destro (come foto)
With right reinforce (same photo) / Avec je renforce droite (come photo)
Mit Verstärkung rechts (wie auf dem Bild) / с фиксацией право

**K 03**

Corrimano di sicurezza orizzontale con 3
attacchi a parete
Horizontal emergency handle with 3 wall attacks
Poignée de sûreté horizontale avec 3 attaques à mur
Bad Sicherheitsgriff mit 3 Wandhalterungen
Перила на 3-х креплениях

• K 03.02 - cm 160 € 165,00

**K 07 INOX**

Impugnatura di sostegno ribaltabile
Rotary support handle en stell-clad
Poigne de soutien tournant en acier inox
Stützklappgriff
Складная ручка
cm 11 L x 60 P x 22 H

• 55 € 280,00

Con dispositivo di bloccaggio in posizione verticale.
With blocking device in vertical position
Avec dispositif de blocage en position verticale
Mit Sperre in die senkrechte Position
Крепеж на клей

**K 08**

Impugnatura di sostegno a parete
Wall support handle
Poigne de soutien à mur
Winkelgriff
Поручень правосторонний угловой
cm 43 L x 74 H

• K 08 SX € 155,00

• K 08 DX come foto € 155,00

same photo / comme photo / wie auf dem Bild/Как фото

**K 04**

Corrimano di sicurezza ad angolo
Corner horizontal emergency handle
Poignée de sûreté horizontale à angle
Eck-Wandhandlauf waagrecht
Угловой поручень











• K 04.02 - cm 70 x 70 € 155,00

• K 04.03 - cm 100 x 100 € 190,00

**1354**

Sedile ribaltabile in ABS e INOX 304 con frizione
Foldable seat in ABS and 304 stainless steel with friction
Siège rabattable en ABS et acier inoxydable 304 avec friction
Klappbarer Sitz aus ABS und Edelstahl 304 mit Reibung
Складное сиденье из ABS и нержавеющей стали 304 с трением
cm 50 L x 35 P x 54 H

• 01 € 310,00

040	Bicchiere di ricambio Glass spare Verre de rechange Ersatz Zahnputzbecher Запасные стаканы	BIANCO White Blanc Weiß	DECORATO COLORATO Decorated - Coloured Décoré - Coloré Bemalt - Farbig
	• 02 Bicchiere in ceramica per GIUNONE Ø cm 8,2 Ceramic glass for Giunone Verre en céramique pour Giunone Zahnputzbecher aus Keramik für Giunone	€ 17,00	
	• 03 Bicchiere in ceramica per NEMI, IDRA Ø cm 7,4 Ceramic glass for Nemi, Idra Verre en céramique pour Nemi, Idra Zahnputzbecher aus Keramik für Nemi, Idra	€ 18,00	€ 28,00
	• 04 Bicchiere in ceramica per SMART, FLORA Ø cm 6,0 Ceramic glass for Smart, Flora Verre en céramique pour Smart, Flora Zahnputzbecher aus Keramik für Smart, Flora	€ 13,00	
	• 05 Bicchiere in vetro per ALFA Ø cm 5,7 Glass for Alfa Verre pour Alfa Zahnputzbecher aus Glas für Alfa	€ 17,00	€ 22,00
	• 06 Bicchiere in vetro per LIZ VETRO Ø cm 5,9 Glass for Liz glass - Verre pour Liz verre - Zahnputzbecher aus Glas für Liz	€ 13,00	€ 18,00
	• 07 Bicchiere in ceramica per ZOE Ø cm 6,0 Ceramic glass for Zoe Verre en céramique pour Zoe Zahnputzbecher aus Keramik für Zoe	€ 10,00	
	• 08 Bicchiere in vetro per MEDEA, DIANA Ø cm 6,2 Glass for Medea, Diana Verre pour Medea, Diana Zahnputzbecher aus Glas für Medea, Diana	€ 24,00	
	• 09 Bicchiere in ceramica con perno per URANIA Ceramic glass with bolt for Urania Verre en céramique avec boulon pour Urania Zahnputzbecher aus Keramik mit Zapfen für Urania	€ 27,00	
	• 11 Bicchiere in vetro per SMART LIGHT, NOTO, MARTE Ø cm 5,9 Glass for Smart Light, Noto, Marte Verre pour Smart Light, Noto, Marte Zahnputzbecher aus Glas für Smart Light, Noto, Marte	€ 30,00	
	• 12 Bicchiere in ceramica con perno per BUCKET, OPERA Ceramic glass with bolt for Bucket, Opera Verre en céramique avec boulon pour Bucket, Opera Zahnputzbecher aus Keramik mit Zapfen für Bucket, Opera	€ 27,00	

040	Bicchiere di ricambio Glass spare Verre de rechange Ersatz Zahnputzbecher Запасные стаканы	BIANCO White Blanc Weiß	DECORATO COLORATO Decorated - Coloured Décoré - Coloré Bemalt - Farbig
	• 13 Bicchiere in ceramica per MIZAR Ceramic glass for Mizar Verre en céramique pour Mizar Zahnputzbecher aus Keramik für Mizar	€ 18,00	
	• 14 Bicchiere in vetro con perno per SATURNO Glass with bolt for Saturno Verre en verre avec boulon pour Saturno Zahnputzbecher aus Glas mit Zapfen für Saturno	€ 40,00	
	• 15 Bicchiere in vetro con perno per VENUS Glass with bolt for Venus Verre en verre avec boulon pour Venus Zahnputzbecher aus Glas mit Zapfen für Venus	€ 36,00	
	• 16 Bicchiere in ceramica con perno per ZEFIRO Ceramic glass with bolt for Zefiro Verre en céramique avec boulon pour Zefiro Zahnputzbecher aus Keramik mit Zapfen für Zefiro	€ 29,00	€ 32,00
	• 17 Bicchiere in ceramica con perno per PRISMA Ceramic glass with bolt for Prisma Verre en céramique avec boulon pour Prisma Zahnputzbecher aus Keramik mit Zapfen für Prisma	€ 30,00	€ 33,00
	• 18 Bicchiere in vetro per ELITE Ø cm 10 Glass for Elite Verre pour Elite Zahnputzbecher aus Glas für Elite	€ 44,00	
	• 19 Bicchiere in ceramica con perno per LIVING, GEA Ceramic glass with bolt for Living, Gea Verre en céramique avec boulon pour Living, Gea Zahnputzbecher aus Keramik mit Zapfen für Living, Gea	€ 30,00	
	• 20 Bicchiere in ceramica con perno per DIVA, FLUID Ceramic glass with bolt for Diva, Fluid Verre en céramique avec boulon pour Diva, Fluid Zahnputzbecher aus Keramik mit Zapfen für L Diva, Fluid	€ 30,00	
	• 21 Bicchiere in ceramica con perno per LIZ Ceramic glass with bolt for Liz Verre en céramique avec boulon pour Liz Zahnputzbecher aus Keramik mit Zapfen für Liz	€ 27,00	

041	Porta sapone di ricambio Soap dish spare Porte savon de rechange Ersatz Seifenschale Запасные мыльницы	BIANCO White Blanc Weiß	DECORATO COLORATO Decorated - Coloured Décoré - Coloré Bemalt - Farbig
	• 03 Porta sapone in ceramica per GIUNONE Ø cm 7,5 Ceramic soap dish for Giunone Porte savon en céramique pour Giunone Seifenschale aus Keramik für Giunone	€ 17,00	
	• 04 Porta sapone in ceramica per NEMI, IDRA Ø cm 7,5 Ceramic soap dish for Nemi, Idra Porte savon en céramique pour Nemi, Idra Seifenschale aus Keramik für Nemi, Idra	€ 18,00	€ 28,00
	• 05 Porta sapone in ceramica per SMART, FLORA Ø cm 6 Ceramic soap dish for Smart, Flora Porte savon en céramique pour Smart, Flora Seifenschale aus Keramik für Smart, Flora	€ 13,00	
	• 06 Porta sapone in ceramica per OMEGA Ø cm 6,2 Ceramic soap dish for Omega Porte savon en céramique pour Omega Seifenschale aus Keramik für Omega	€ 13,00	
	• 07 Porta sapone in vetro per ALFA, ELITE, DIANA Ø cm 6,2 Glass soap dish for Alfa, Elite, Diana Porte savon en verre pour Alfa, Elite, Diana Seifenschale aus Glas für Alfa, Elite, Diana	€ 17,00	€ 22,00
	• 08 Porta sapone in vetro per LIZ VETRO Ø cm 5,9 Glass soap dish for Liz glass Porte savon en verre pour Liz verre Seifenschale aus Glas für Liz	€ 13,00	
	• 10 Porta sapone in ceramica con perno per URANIA Ceramic soap dish with bolt for Urania Porte savon en céramique avec boulon pour Urania Seifenschale aus Keramik mit Zapfen für Urania	€ 25,00	
	• 12 Porta sapone in vetro per SMART LIGHT, NOTO, MARTE Ø cm 6,2 Glass soap dish for Smart Light, Noto, Marte Porte savon en verre pour Smart Light, Noto, Marte Seifenschale aus Glas für Smart Light, Noto, Marte	€ 19,00	
	• 14 Porta sapone in ceramica per MIZAR Ceramic soap dish for Mizar Porte savon en céramique pour Mizar Seifenschale aus Keramik für Mizar	€ 18,00	
	• 15 Porta sapone in vetro con perno per SATURNO Glass soap dish with bolt for Saturno Porte savon en verre avec boulon pour Saturno Seifenschale aus Glas mit Zapfen für Saturno	€ 26,00	

041	Porta sapone di ricambio Soap dish spare Porte savon de rechange Ersatz Seifenschale Запасные мыльницы	BIANCO White Blanc Weiß	DECORATO COLORATO Decorated - Coloured Décoré - Coloré Bemalt - Farbig
	• 16 Porta sapone in ceramica con perno per ZEFIRO Ceramic soap dish with bolt for Zefiro Porte savon en céramique avec boulon pour Zefiro Seifenschale aus Keramik mit Zapfen für Zefiro	€ 22,00	€ 26,00
	• 17 Porta sapone in ceramica con perno per PRISMA Ceramic soap dish with bolt for Prisma Porte savon en céramique avec boulon pour Prisma Seifenschale aus Keramik mit Zapfen für Prisma	€ 21,00	€ 29,00
	• 19 Porta sapone in ceramica con perno per GEA Ceramic soap dish with bolt for Gea Porte savon en céramique avec boulon pour Gea Seifenschale aus Keramik mit Zapfen für Gea	€ 25,00	
	• 20 Porta sapone in ceramica con perno per DIVA, FLUID Ceramic soap dish with bolt for Diva, Fluid Porte savon en céramique avec boulon pour Diva, Fluid Seifenschale aus Keramik mit Zapfen für Diva, Fluid	€ 25,00	
	• 21 Porta sapone in ceramica con perno per BUCKET, OPERA Ceramic soap dish with bolt for Bucket, Opera Porte savon en céramique avec boulon pour Bucket, Opera Seifenschale aus Keramik mit Zapfen für Bucket, Opera	€ 25,00	
	• 22 Porta sapone in ceramica con perno per LIZ Ceramic soap dish with bolt for Liz Porte savon en céramique avec boulon pour Liz Seifenschale aus Keramik mit Zapfen für Liz	€ 25,00	

037	Dosatore sapone liquido di ricambio Liquid soap dispenser spare Doseur de savon liquid de rechange Ersatz Seifenspender Запасные дозаторы	BIANCO White Blanc Weiß	COLORATO Coloured Coloré Farbig
	• 01 Dosatore in vetro per ELITE, LIZ VETRO Ø cm 6,0 Glass dispenser for Elite, Liz glass Doseur en verre pour Elite, Liz Seifenspender aus Glas für Elite, Liz	€ 18,00	€ 29,00
	• 03 Dosatore in vetro per DIANA Ø cm 6,2 Glass dispenser for Diana Doseur en verre pour Diana Seifenspender aus Glas für Diana	€ 25,00	
	• 04 Dosatore in ceramica per SMART Ø cm 6,0 Ceramic dispenser for Smart Doseur en céramique pour Smart Seifenspender aus Keramik für Smart	€ 19,00	
	• 06 Dosatore in ceramica con perno per URANIA Ceramic dispenser with bolt for Urania Doseur en céramique avec boulon pour Urania Seifenspender aus Keramik mit Zapfen für Urania	€ 36,00	
	• 07 Dosatore in vetro con perno per VENUS Ø cm 6,0 Glass dispenser with bolt for Venus Doseur en verre avec boulon pour Venus Seifenspender aus Glas mit Zapfen für Venus	€ 35,00	
	• 10 Dosatore in ceramica con perno per BUCKET, OPERA Ø cm 7,0 Ceramic dispenser with bolt for Bucket, Opera Doseur en céramique avec boulon pour Bucket, Opera Seifenspender aus Keramik mit Zapfen für Bucket, Opera	€ 35,00	
	• 11 Dosatore in ceramica per MIZAR Ø cm 6,2 Ceramic dispenser for Mizar Doseur en céramique pour Mizar Seifenspender aus Keramik für Mizar	€ 34,00	
	• 12 Dosatore in ceramica con perno per ZEFIRO Ø cm 6,0 Ceramic dispenser with bolt for Zefiro Doseur en céramique avec boulon pour Zefiro Seifenspender aus Keramik mit Zapfen für Zefiro	€ 34,00	€ 40,00
	• 13 Dosatore in ceramica con perno per PRISMA Ceramic dispenser with bolt for Prisma Doseur en céramique avec boulon pour Prisma Seifenspender aus Keramik mit Zapfen für Prisma	€ 36,00	€ 41,00
	• 14 Dosatore in vetro con perno per SATURNO Glass dispenser with bolt for Saturno Doseur en verre avec boulon pour Saturno Seifenspender aus Glas mit Zapfen für Saturno	€ 45,00	
	• 15 Dosatore in ceramica con perno per LIVING Ceramic dispenser with bolt for Living Doseur en céramique avec boulon pour Living Seifenspender aus Keramik mit Zapfen für Living	€ 37,00	







037	Dosatore sapone liquido di ricambio Liquid soap dispenser spare Doseur de savon liquid de rechange Ersatz Seifenspender Запасные дозаторы	BIANCO White Blanc Weiß	COLORATO Coloured Coloré Farbig
	• 16 Dosatore in vetro per SMART LIGHT, NOTO, MARTE Ø cm 6,2 Glass dispenser for Smart Light, Noto, Marte Doseur en verre pour Smart Light, Noto, Marte Seifenspender aus Glas für Smart Light, Noto, Marte	€ 32,00	
	• 17 Dosatore in ceramica per LIZ Ceramic dispenser for Liz Doseur en céramique pour Liz Seifenspender aus Keramik für Liz	€ 37,00	
	• 18 Dosatore in ceramica per DIVA Ceramic dispenser for Diva Doseur en céramique pour Diva Seifenspender aus Keramik für Diva	€ 37,00	
	• PA Pompetta per dosatore (cromo) Dispenser pump's (chrome) Pompe pour doseur (chromé) Pumpe für Seifenspender (Chrom)	€ 30,00	€ 46,00
	• PB Pompetta per dosatore Dispenser pump's Pompe pour doseur Pumpe für Seifenspender	€ 34,00	€ 48,00
	• PQ Pompetta per dosatore Dispenser pump's Pompe pour doseur Pumpe für Seifenspender	€ 48,00	€ 60,00
	• PL Pompetta per dosatore Dispenser pump's Pompe pour doseur Pumpe für Seifenspender	€ 48,00	









042	Tazza per scopino di ricambio Container for toilet-brush Containeur pour balayent Ersatz Behälter für Bürstengarnitur Запасная колба от ерша	BIANCO White Blanc Weiß	DECORATO Decorated Décoré Bemalt
	• 02 Tazza in ceramica per: G 12/i 20/i 21 Ø cm 8,3x H22 Ceramic container for: G 12/i 20/i 21 Containeur en céramique pour: G 12/i 20/i 21, Behälter aus Keramik für: G 12/i 20/i 21	€ 30,00	
	• 03 Tazza in ceramica per: G 12a/i 12a (foto) Ceramic container for: G 12a/i 12a Containeur en céramique pour: G 12a/i 12a Behälter aus Keramik für: G 12a/i 12a	€ 41,00	
	• 04 Tazza in ceramica per GABRY 186 Ceramic container for Gabry 186 Containeur en céramique pour Gabry 186 Behälter aus Keramik für Gabry 186	€ 40,00	€ 50,00
	• 05 Tazza in vetro per ELITE, QUID, VENUS Ø cm 8,0x H23 Glass container for Elite, Quid, Venus Containeur en verre pour Elite, Quid, Venus Behälter aus Glas für Elite, Quid, Venus	€ 30,00	€ 40,00
	• 09 Tazza in ceramica per BUCKET Ceramic container for Bucket Containeur en céramique pour Bucket Behälter aus Keramik für Bucket	€ 32,00	
	• 11 Tazza in ceramica per URANIA Ceramic container for Urania Containeur en céramique pour Urania Behälter aus Keramik für Urania	€ 40,00	
	• 12 Tazza in ceramica per ZEFIRO Ceramic container for Zefiro Containeur en céramique pour Zefiro Behälter aus Keramik für Zefiro	€ 60,00	
	• 13 Tazza in ceramica per COSI' Ceramic container for Cosi Containeur en céramique pour Cosi Behälter aus Keramik für Cosi	€ 60,00	
	• 14 Tazza in ceramica per LIVING, GEA Ceramic container for Living, Gea Containeur en céramique pour Living, Gea Behälter aus Keramik für Living, Gea	€ 48,00	
	• 15 Tazza in ceramica per ARIA Ceramic container for Aria Containeur en céramique pour Aria Behälter aus Keramik für Aria	€ 48,00	€ 60,00
	• 16 Tazza in ceramica per 972, ME 972 Ceramic container for 972, ME972 - Containeur en céramiq- ue pour 972, ME972 - Behälter aus Keramik für 972, ME972	€ 58,00	

042	Tazza per scopino di ricambio Container for toilet-brush Containeur pour balayent Ersatz Behälter für Bürstengarnitur Запасная колба от ерша	BIANCO White Blanc Weiß	DECORATO Decorated Décoré Bemalt
	• 17 Tazza in ceramica per DIVA, FLUID Ceramic container for Diva, Fluid Containeur en céramique pour Diva, Fluid Behälter aus Keramik für Diva, Fluid	€ 48,00	
	• 039F2 Tazza in PVC Ø 7cm PVC container ø 7cm Containeur en PVC ø 7cm Behälter aus PVC ø 7cm	€ 12,00	
	• CER 1200 Tazza in ceramica per Switch Ceramic container for Switch Containeur en céramique pour Switch Behälter aus Keramik für Switch	€ 48,00	€ 59,00
	• CER 796 Tazza in ceramica per PRISMA Ceramic container for Prisma Containeur en céramique pour Prisma Behälter aus Keramik für Prisma	€ 48,00	€ 59,00

095	Base di ricambio Spare Base Base de rechange Ersatz Fußplatte Запасная основа	CROMO Chrome Chrome Chrom	ORO-BRONZO Gold-Bronze Or-Bronze Gold-Bronze	
	<p>• 095.01 Base in ottone senza peso per piantane ø 25cm Brass base without weight for stands ø 25cm Base en laiton sans poids pour montants ø 25cm Fußplatte aus Messing ohne Beschwerung für Ständer ø 25 cm</p>	€ 55,00	€ 65,00	
	<p>• 095.02 Base in ottone con peso per piantane Di 19 / U 19 Brass base with weight for Di 19 / U 19 Base en laiton pour montants pour Di 19 / U 19 Fußplatte aus Messing mit Beschwerung für Ständer Di 19 / U 19</p>	€ 78,00		
	<p>• 01 Base in ottone per piantane senza peso ø 20cm Brass base without weight ø 20cm Base en laiton pour montants sans poids ø 20cm Fußplatte aus Messing ohne Beschwerung für Ständer ø 20cm</p>	€ 48,00	€ 55,00	
091	Finale di ricambio End-knob Final de rechange Ersatz Endteil Запасная насадка	LEGNO OTTONE Wood-brass Bois-laïton Holz-Messing	VETRO CERAMICA BIANCA White glass-ce- ramic Verre-céramique Blanc Weiß Glas-Keramik	DECORATO Decorated Décoré Bemalt
	<p>• 01 Finale per NEMI End-knob for Nemi Endteil für Nemi</p>	€ 10,00	€ 14,00	€ 20,00
	<p>• 02 Finale per ALFA End-knob for Alfa Endteil für Alfa</p>	€ 9,00	€ 12,00	
	<p>• 06 Finale per SMART LIGHT End-knob for Smart Light Endteil für Smart Light</p>		€ 24,00	

050	Manico con ciuffo di ricambio Handle with brush Poignée avec touffe Griff und Ersatzbürstenkopf Запасная щетка от ерша	CROMO BIANCO White-Chrome Blanc- Chromé Weiß-Chrom	ORO-BRONZO Gold-Bronze Or-Bronze Gold-Bronze
	<p>• 050.01 Manico per Gabry Handle for Gabry Poignée pour Gabry Griff für Gabry</p>	€ 24,00	€ 40,00
	<p>• 050.02 Manico con ciuffo in PVC Handle with PVC brush Poignée avec touffe en PVC Griff und Bürstenkopf aus Kunststoff (PVC)</p>	€ 27,00	
	<p>• 050.03 Manico + ciuffo in setola + coperchio per scopino Handle + bristle brush + cover toilet-brush Poignée + touffe en brin + couvercle pour balayent Griff + Bürstenkopf mit Borsten + Deckel</p>	€ 34,00	€ 39,00
	<p>• 050.04 Coperchio in ottone per scopino ø cm 8 Brass cover for toilet-brush Couvercle en laiton pour balayent Deckel aus Messing für Bürstengarnitur</p>	€ 16,00	€ 19,00
	<p>• 093 Ciuffo in PVC grande di ricambio Spare PVC big brush Touffe grand en PVC de rechange Bürstenkopf groß aus PVC</p>	€ 8,00	
	<p>• 051 Rullino per porta rotolo di ricambio Spare part for paper holder Rechange pour porte rolou Ersatzteil für Rollenhalter</p>	€ 7,00	

103	Manico con ciuffo di ricambio Handle with brush Poignée avec touffe Griff und Ersatzbürstenkopf Запасная щетка от ерша	CROMO BIANCO White-Chrome Blanc- Chromé Weiß-Chrom	ORO-BRONZO Gold-Bronze Or-Bronze Gold-Bronze
	<p>• 103 Gambo con ciuffo in setola cm 20 Ø 55 Stem with bristle brush cm 20 Ø 55 Tige avec touffe en brin cm 20 Ø 55 Stielbürste und Bürstenkopf, Borsten cm 20 Ø 55</p>	€ 13,00	
	<p>• 103.NE Nero / Black / Noir / Swarz / Чрoм Gambo con ciuffo in setola cm 21 Stem with bristle brush cm 21 Tige avec touffe en brin cm 21 Stielbürste und Bürstenkopf, Borsten cm 21</p>	€ 13,00	
	<p>• 103.65 Gambo con ciuffo in setola cm 21 x Ø 65 Stem with bristle brush cm 21 x Ø 65 Tige avec touffe en brin cm 21 x Ø 65 Stielbürste und Bürstenkopf, Borsten cm 21 x Ø 65</p>	€ 13,00	
	<p>• 103.COSÌ Gambo con ciuffo in setola cm 17 x Ø 55 Stem with bristle brush cm 17 x Ø 55 Tige avec touffe en brin cm 17 x Ø 55 Stielbürste und Bürstenkopf, Borsten cm 17 x Ø 55</p>	€ 13,00	
	<p>• 103.IN Gambo con ciuffo in setola cm 12 x Ø 65 Stem with bristle brush cm 12 x Ø 65 Tige avec touffe en brin cm 12 x Ø 65 Stielbürste und Bürstenkopf, Borsten cm 12 x Ø 65</p>	€ 13,00	
	<p>• 103.IN 55 Gambo con ciuffo in setola cm 11 x Ø 55 per 1946 Stem with bristle brush cm 11 x Ø 55 for 1946 Tige avec touffe en brin cm 11 x Ø 55 pour 1946 Stielbürste und Bürstenkopf, Borsten cm 11 x Ø 55 für 1946</p>	€ 13,00	

VET	Paralumi di ricambio Spare lampshades Abat-jour de rechange Ersatz Lampenläser абажуром замена	BIANCO White Blanc Weiß	DECORATO COLORATO Decorated - Coloured Décoré - Coloré Bemalt - Farbig
	<p>• VET N 17 Vetro per N 17 Glass for N 17 Verre pour N 17 Lampenglas für N 17</p>	€ 51,00	€ 59,00
	<p>• VET 692 Vetro per 692 Glass for 692 Verre pour 692 Lampenglas für 692</p>	€ 56,00	
	<p>• VET CA 17 Vetro per CA 17 Glass for CA 17 Verre pour CA 17 Lampenglas für CA 17</p>	€ 49,00	
	<p>• VET 774 Vetro Pirex per 774 Glass Pirex for 774 Verre Pirex pour 774 Pyrex Glas für 774</p>	€ 34,00	
	<p>• LAMPG9LED LED G9 30W 3000K 250 Lumen Lampada Bulb Ampoule Lamp</p>	€ 17,00	
	<p>• TRASF Trasformatore 15 W transformer 15 W transformateur 15 W transformator 15 W</p>	€ 29,00	
	<p>• TRASF 2 Trasformatore 20 W transformer 20 W transformateur 20 W transformator 20 W</p>	€ 36,00	
	<p>• TRASF 8 Trasformatore 30 W transformer 30 W transformateur 30 W transformator 30 W</p>	€ 44,00	
	<p>• TRASF 12 Trasformatore 60 W transformer 60 W transformateur 60 W transformator 60 W</p>	€ 65,00	



EXPO 17
 Pannello espositore con presentazione fotografica
 Displayboard with picture
 Présentoir avec photo
 Ausstellungspaneel mit Fotopräsentation
 Выставочная панель с презентацией фотографий
 cm 60 L x 20 H



EXPO BOX

EXPO BOX
 Cofanetto con accessori e finiture
 Kit with accessories and finishes
 Coffret avec accessoires et finitions
 Set mit Zubehör und Ausführungen
 Набор с аксессуарами и отделками
 cm 40 L x 30 P x 10 H



EXPO 1

EXPO 1
 Pannello espositore su ruote
 Display board on wheels
 Présentoir sur des roues
 Ausstellungsstand auf Rollen
 Напольный стенд на колесах
 cm 60 L x 42 P x 190 H

CONDIZIONI DI VENDITA

TERMS OF SALE FOR EXPORT/ CONDITIONS DE VENTE POUR L'EXPORTATION
VERKAUFSBEDINGUNGEN GILT FÜR AUSLÄNDISCHE / УСЛОВИЯ ПРОДАЖИ

ACCETTAZIONE DELL'ORDINE E VALIDITÀ - Ogni ordine, variazione o annullamento devono pervenire per iscritto al nostro ufficio vendite, tramite cliente o Agenti. Gli ordini incompleti o privi di informazioni che non ne permettono una corretta esecuzione, possono subire ritardi di registrazione. Ogni ordine superiore a €750,00 + IVA, sarà valido se accettato con conferma d'ordine. In caso di annullamento ordine SPECIALE già eseguito ci riserviamo di addebitare il 50% del costo dello stesso. Le Condizioni Generali di Vendita si applicano a tutti i rapporti con i Clienti e s'intendono tacitamente accettate senza rinnovo ad ogni singolo ordinativo.

TEMPI DI CONSEGNA - I tempi di consegna sono espressi in giorni lavorativi e devono intendersi meramente indicativi; eventuali ritardi di consegna non danno diritto alla risoluzione del contratto, tanto meno ad indennizzi o risarcimenti di sorta. Gli ordini possono essere evasi anche parzialmente.

CONTROLLO DEL MATERIALE - RESI - La merce viaggia a rischio e pericolo del committente ai sensi dell'art. 1510 del codice civile; contestare eventuali danni direttamente al vettore anche quando la merce è recapitata in porto franco e comunque inviare entro 24 ore dal ricevimento un email all'Azienda, indicando i riferimenti della fattura, articolo, quantità, motivazione ed eventuali immagini dell'insieme e del particolare contestato. Non si accettano resi di merce se non espressamente autorizzati per iscritto e comunque franchi di ogni spesa al magazzino della nostra sede. I resi causati da errori di trasmissione dell'ordine da parte del cliente verranno accreditati all'80% del prezzo netto di vendita. Per resi autorizzati, utilizzare l'imballo originale. Non si accettano richieste di resi di articoli speciali o articoli fuori produzione, pur rimanendo disponibili ad eventuali valutazioni che dovessero necessitare. Non si accettano richieste di resi per difetti visibili o di natura estetica, di materiali già installati. Il mancato rispetto di quanto sopra può provocare l'immediato decadimento della garanzia.

TOLLERANZE - Le illustrazioni dei nostri prodotti, deplianti e cataloghi, non costituiscono impegno di fedele riproduzione, la ditta si riserva il diritto di apportare modifiche ai propri prodotti senza l'obbligo di preavviso.

CONDIZIONI DI PAGAMENTO - Il mancato rispetto dei termini di pagamento, comporta l'addebito degli interessi al tasso prime-rate ABI maggiorato di 3 punti a far data dall'emissione della fattura + € 15,00 per recupero spese. E' facoltà della ditta sospendere le consegne di clienti inadempienti. L'azienda si riserva la proprietà delle merci non ancora pagate.

CONTRASSEGNO - Le spedizioni di importo totale inferiore a € 150,00 saranno effettuate in contrassegno o bonifico anticipato.

TRASPORTI - Il trasporto è franco per importi di imponibile superiore ad e 250,00, in caso contrario si provvederà al recupero in fattura di € 15,00.

Per ISOLE:

- Per importi di imponibile inferiore ad € 700,00 il contributo per il trasporto è pari ad € 18,00;
- per importi superiori a € 700,00 il trasporto è franco.
- Spedizioni ad indirizzo privato, contributo integrativo € 15,00

IMBALLI - Per spedizioni di materiali con pallet si provvederà al recupero in fattura di € 10,00.

IMBALLI PER SPEDIZIONI SPECCHI - Per spedizioni si provvederà al recupero in fattura di: € 5,00 netti a specchio per misure fino cm150, € 10,00 netti a specchio per misure superiori cm 150

IMBALLO CON CASSA - Su richiesta, per spedizioni di specchi con cassa in legno si provvederà al recupero in fattura di € 40,00

FORNITURE - Per forniture personalizzate e grandi volumi le condizioni di vendita e di trasporto verranno stabilite su preventivo.

LE PRESENTI CONDIZIONI DI VENDITA SI INTENDONO ACCETTATE CON L'ORDINE

CONDIZIONI VALIDE SOLO PER IL MERCATO ITALIANO

RAEE - Iscr. Al Registro A.E.E. n. IT 3110000008191, i prezzi delle illuminazioni non comprendono il contributo.

PRIVACY - Ai sensi della legge DL 196/2003 e del regolamento (UE) n. 2016/679 (GDPR), Stilhaus Arredo Bagno srl dichiara che i dati messi a disposizione dal committente verranno elaborati nel rispetto della legge sulla tutela della privacy.



ORDERS - All orders must be accepted by STILHAUS srl, no order can be cancelled without the written consent of the STILHAUS srl. Cancelled orders are subject to payment cancellation charges to cover all costs incurred by the company up to date of cancellation. Orders can be delivered partially too.

PRICES - The price-list does not include VAT, and prices can change whitout notice. All goods are sold ex works STILHAUS's factory.

DELIVERY - The delivery time starts from the date of the order-confirmation. The goods travel at buyer's risk even if sold free of carriage, the consignee must check the goods on their arrival and claim immediately eventual damages directly to the carrier who is the responsible. Any complaint must be presented in written form within 24 hours from receipt of the goods: otherwise STILHAUS SRL will not acknowledge any compensation for damages or assessed breakages.

RAE - Iscr. Register to A.E.E. n. 3110000008191 IT, prices do not include the contribution of the illuminations

PAYMENT TERMS - Payments must be done according to the terms agreed upon and indicated on our order confirmation; in case of delayed payments STILHAUS reserves itself the right to debit the purchaser with the applicable interests. The supplied products remain property of STILHAUS srl up to complete payment of the price.

RETURNS - Returned goods are not accepted if not agreed previously with STILHAUS by written authorization. Damage caused by an improper installation or wrong use are not covered by any guarantee.

LAW COURT - For any controversy the Court of Viterbo is the only competent authority.

In order to improve its products, STILHAUS reserves itself the right to modify the thecnical data, aesthetic and dimensional peculiarities without notice.

ALL THE ABOVE MENTIONED CONDITIONS ARE CONSIDERED AS FULLY ACCEPTED WHEN PLACING THE ORDER

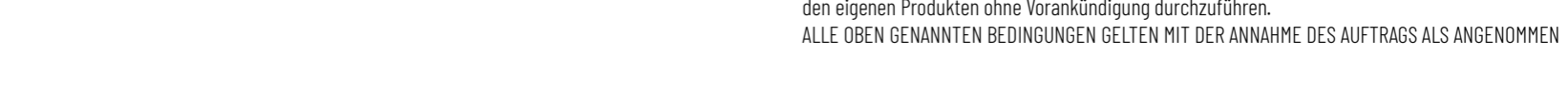

COMMANDES - Toutes les commandes sont sujettes à l'approbation de STILHAUS srl. Aucune commande ne peut être annulée sans préalable approbation de STILHAUS srl, qui se réserve en tous cas le droit de débiter éventuels coûts soutenus jusqu'à la date de l'annulation. Les commandes peuvent être livrées partiellement.

PRIX - Nos marchandises sont facturées sur la base des tarifs en vigueur au jour de la livraison et peuvent varier sans précision. Le tarif ne comprend pas de TVA et la marchandise est vendue départ usine STILHAUS.

LIVRAISON - Le délai de livraison commencent à partir de la date de confirmation de l'a commande etsont toujours indicatifs. Le transfert du risque s'effectue vers l'acheteur au moment de l'expédition, même en cas de livraison franco. Le destinataire est obligé de vérifier les marchandises arrivées et de réclamer les éventuels dommages immédiatement directement au transporteur qui en est le responsable. En ce qui concerne la conformité, la quantité et la qualité apparente de la marchandise livrée par rapport à celle commandée, l'acheteur doit nous adresser ses réclamations éventuelles par écrit au plus tard dans un délai de 24 HEUERES après réception. Au delà les réclamations ne sont plus recevables.

RAEE - Iscr. Inscrivez-vous pour A.E.E. n. 3110000008191 IT, prix ne comprennent pas la contribution des illuminations

PAIEMENT - Les termes de paiement ne peuvent pas être retardés pour quelque cause que ce soit, même en cas de litige. Dans le cas de paiement retardé STILHAUS se réserve ledroit de débiter à l'acheteur les intérêts applicables. Les produits fournis restent propriété de STILHAUS srl jusqu'au paiement complet du prix.

GARANTIE - Notre garantie couvre tous défauts de fabrication à condition que notre produit ait été installé conformément à nos instructions de montage et aux règles de l'art. Notre garantie est limitée à la remise en état ou remplacement de la pièce reconnue défectueuse. La garantie ne couvre, en aucun cas, les frets de main d'oeuvre, des frais de déplacement, choc, utilisation de produits de nettoyage corrosifs ou abrasifs.

RETOURS - Aucun retour de marchandise ne peut-être effectué sans notre accord écrit.

CARACTÉRISTIQUES DU PRODUIT - Pour améliorer ses produits, STILHAUS se réserve le droit de modifier les données techniques, esthétique caractéristiques et dimensionnels sans avis.



CONTESTATIONS - En cas de contestation, le Tribunal de Viterbo est la seule juridiction reconnue et acceptée de part et d'autre.

TOUTES LES CONDITIONS SURMENTIONNÉES SONT CONSIDÉRÉES COMPLÈTEMENT ACCEPTÉES EN PASSANT LA COMMANDE

AUFTRÄGE - Alle Aufträge müssen von der STILHAUS srl bestätigt werden. Kein Auftrag kann ohne die schriftliche Zustimmung von STILHAUS srl annulliert werden. Die Kosten der Annullierung des Auftrags müssen vom Kunden getragen werden. Die Aufträge können partiell verändert werden.

PREISE - Die Preise beinhalten nicht die Mehrwertsteuer und können ohne Vorankündigung verändert werden. Alle Waren werden frei Fabrikhallen bereitgestellt.

LIEFERBESTIMMUNGEN - Die Lieferzeit beginnt mit dem Datum der Auftragsbestätigung. Die Waren werden nach Auftrag und zu Lasten des Käufers versandt. Der Käufer muss die Waren bei der Ankunft kontrollieren und eventuelle Schäden unverzüglich der betrauten Spedition melden. Was die Auftragskonformität, Qualität und Menge der gelieferten Waren betrifft, so muß der Käufer eventuelle Unstimmigkeiten innerhalb von 24 Stunden nach der Lieferung melden. Außerhalb der Fristen werden Reklamationen nicht akzeptiert.

RAEE - Iscr. Registrieren A.E.E. n. 3110000008191 IT, Preise enthalten keine Leuchtmittel

ZAHLUNGSMODALITÄTEN - Die Zahlung muss nach den Bestimmungen erfolgen die auf der Auftragsbestätigung vereinbart wurden. Im Falle einer verspäteten Zahlung, behält sich Stilhaus das Recht vor dem Käufer die Zinsen in Rechnung zu stellen. Die gelieferten Waren bleiben bis zur vollständigen Bezahlung Eigentum von STILHAUS srl.

RÜCKGABE - Durch nicht sachgemäße Installation und Gebrauch verursachte Schäden werden nicht von der Garantie gedeckt.

BESCHWERDE - Beschwerden- Gerichtsort ist Viterbo.

TOLLERANZEN - Mit dem Ziel die Produkte zu verbessern, behält sich Stilhaus vor, Veränderungen an den eigenen Produkten ohne Vorankündigung durchzuführen.

ALLE OBEN GENANNTEN BEDINGUNGEN GELTEN MIT DER ANNAHME DES AUFTRAGS ALS ANGENOMMEN



Заказы – все заказы должны быть приняты фабрикой Stil Haus, заказ не может быть аннулирован без письменного оповещения фабрикой. Отмененные заказы подлежат возврату денежных средств. Заказы также могут быть доставлены частично.

Цены – Прайс-лист не включает НДС, и цены в счете могут быть другими. Все товары вывозятся с фабрики самостоятельно.

Поставки – Срок поставки начинается с момента подтверждения заказа. Все риски ложатся на покупателя. Все претензии рассматриваются в письменной форме в течении 24 часов после получения товара. В противном случае фабрика Stil Haus не несет ответственности за возмещение поврежденного груза.

RAEE - ISCR. Зарегистрируйся, чтобы A.E.E. n. 3110000008191 IT, Цены не включают вклад иллюминации

Условия оплаты – оплата может быть произведена в соответствии с выставленным счетом. В случае задержки оплаты, фабрика оставляет за собой право не отгружать неоплаченный товар до момента погашения полной стоимости товара.

Возврат товара – Возврат товара не принимается если он не был согласован ранее письменно с фабрикой.

Гарантия не распространяется при неправильной установке, при неправильном использовании.

Единственным органом – способным разрешить спорные ситуации, является суд Витербо. С целью улучшения продуктов STILHAUS оставляет за собой право изменять технические характеристики, габариты и внешний вид изделий без предварительного уведомления.

ВСЕМИ ВЫШЕПЕРЕЧИСЛЕННЫМИ УСЛОВИЯМИ СЧИТАЮТСЯ КОГДА ВЫ СОГЛАСНЫ ПОДТВЕРДИТЬ ЗАКАЗ.

TABELLA COLORI

COLOUR CHART / TABLEAU COULEURS / FARBENTABELLE / ДИАГРАММА ЦВЕТА

La cromatura viene effettuata su particolari che vengono sottoposti ai seguenti trattamenti: pulimentatura, sgrassatura chimica con ultrasuoni, sgrassatura elettrolitica, nichelatura lucida livellante con uno spessore medio di 18-20 micron; cromatura con spessore medio di 0,3 micron.

Cromature conformi al test di salinità secondo la norma UNI ISO 9227 NSS.

La doratura viene eseguita con oro 24 karati con spessore medio di 0,04 micron e verniciatura trasparente con cottura a forno a 180°C.

La lavorazione PVD consiste nella deposizione di film metallici sottili su diverse tipologie di substrati. Il processo avviene all'interno di camere sotto vuoto, dove vengono evaporati i metalli che si intendono depositare, come ad esempio zirconio, cromo e titanio.



The chrome-plating is effected on component that are treated with the following processes: Polishing, chemical ultrasonic cleaning, electrolytic degreasing, shiny nickel-plating with a average thickness of 18-20 microns; chromium plating with average thickness of 0,3 microns. Salinity test UNI ISO 9227 NSS is carried out.

The gilding is performed with gold 24 karats with average thickness of 0,04 microns coated by a transparent painting in oven cooking at 180°C.

PVD processing consists of the deposition of thin metal films on different types of substrates. The process takes place inside vacuum chambers, where the metals to be deposited, such as zirconium, chromium and titanium, are evaporated.

Die Verchromungen werden auf Einzelteilen angebracht die folgenden Verfahren unterzogen werden:

Säuberung, chemische Entfettung mit Ultraschall, elektrolytische Entfettung, Vernickelung mit einer Stärke von ca. 18-20 Mikron. Verchromung mit einer Stärke von ca. 0.3 Mikron. Verchromung entspricht der Norm UNI ISO 9227 NSS.

Die Vergoldung wird mit 24 karätigem Gold in einer durchschnittlichen Stärke von 0,04 Mikron ausgeführt und mit einer transparenten Beschichtung bei 180 grad im Ofen gebrannt.

PVD (Physical Vapor Deposition) ist der Prozess, bei dem dünne metallische Filme auf verschiedene Arten von Substraten aufgebracht werden. Der Prozess findet in Vakuumkammern statt, in denen Metalle wie Zirkonium, Chrom und Titan verdampft und abgelagert werden.

Le chromage est effectué sur des parties qui subissent les suivants traitements: Polissage, dégraissage chimique par Ultrasons, dégraissage électrolytique, nickelage Brillant avec une épaisseur moyenne de 18-20 Microns; chromage avec épaisseur moyenne de 0,3 microns. Test de salinité UNI ISO 9227 NSS effectué. La dorure est réalisée en or 24 Carates avec épaisseur moyenne de 0,04 microns et couverte par une peinture transparente cuite au four à 180°C. La technique PVD (dépôt physique en phase vapeur) consiste à déposer des films métalliques minces sur différents types de substrats. Le processus se déroule à l'intérieur de chambres sous vide, où des métaux tels que le zirconium, le chrome et le titane sont évaporés et déposés.

Хромирование осуществляется на детали, которые проходят следующие процедуры: Полировка, обезжиривание и технология ультразвуковой очистки, глянцевое никелирование средней толщиной 18-20 мкм, хромирование толщиной в 0,3 мкм. Хромирование используется в соответствии со стандартом UNI ISO 9227 NSS. Золочение осуществляется 24 каратами средней толщиной 0,04 мкм и прозрачным покрытием при температуре 180° с.

PVD (физическое осаждение из пара) - это процесс нанесения тонких металлических пленок на различные типы подложек. Процесс происходит в вакуумных камерах, где металлы, такие как цирконий, хром и титан, испаряются и осаждаются.

FINITURE DISPONIBILI / AVAILABLE FINISHINGS

02	CROMO - ORO / Chrome - Gold ELITE / GIUNONE / SMART / BUCKET
03	BIANCO - CROMO / White - Chrome GIUNONE / LIVING / BUCKET / TOTEM
04	BIANCO - ORO / White - Gold PROGETTO SARTORIA
05	NERO - CROMO / Black - Chrome LIVING / BUCKET / TOTEM
07	CROMO SATINATO VERNICIATO LUCIDO / Satin chrome glossy painted PROGETTO SARTORIA
08	CROMO / Chrome ARIA / URANIA / DIANA / MEDEA / EASY / GEA / LIVING / BUCKET / DIVA / MARTE / PRISMA / SMART / SMART LIGHT / ELITE / GIUNONE / NEMI / MARTE / MIZAR / OPERA / RAIL / REGAL / TOTEM / EQUILIBRIUM
09*	OTTONE NATURALE / Natural Brass PROGETTO SARTORIA
10*	OTTONE LUCIDO / Polished brass RAIL / MEDEA
12	NICHEL LUCIDO / Polish nickel PROGETTO SARTORIA
14*	ORO CHIARO / Light gold PROGETTO SARTORIA
15*	ORO SATINATO / Satin gold PROGETTO SARTORIA
16	ORO / Gold ELITE / GIUNONE / SMART LIGHT / MARTE / MEDEA / PRISMA / REGAL
17	ORO ROSA / Rose gold PROGETTO SARTORIA

18	ORO OPACO / Matt gold GEA / HASHI / MEDEA / REGAL / EQUILIBRIUM
19*	ORO INGLESE / English gold PROGETTO SARTORIA
20	CROMO-ORO OPACO / Chrome-matt gold BUCKET
23	NERO OPACO / Black Matt URANIA / KREA / HASHI / MEDEA / BUCKET / RAIL / EQUILIBRIUM / MILANO
24	BIANCO OPACO / White Matt HASHI / BUCKET / MEDEA / MILANO
25	BRONZO / Bronze PRISMA / ELITE / GIUNONE / SMART / SMART LIGHT / MARTE / REGAL
26	RAME / Copper ELITE / GIUNONE
27*	BRONZO OPACO / Matt bronze ELITE
28*	BRONZO SCURO OPACO / Dark matt bronze PROGETTO SARTORIA
33	CROMO - LEGNO NOCE / Chrome - Dark walnut wood NEMI
36	NICHEL SATINATO / Satin nickel URANIA / MEDEA / ELITE / GIUNONE / PRISMA / RAIL / MARTE / HASHI / EQUILIBRIUM
37*	NICHEL SATINATO OPACO / Matt satin nickel PROGETTO SARTORIA
39	CROMO - CERAMICA BIANCA / Chrome - white pottery NEMI

40	CROMO - CERAMICA DECORATA / Chrome - decorated pottery NEMI
54	ACCIAIO SATINATO / Satin steel SATURNO / KREA
55	ACCIAIO LUCIDO / Satin steel HOTELLERIE
56*	NICKEL NERO LUCIDO / Glossy black nickel HASHI
57*	NICKEL NERO SATINATO / Satin black nickel PROGETTO SARTORIA
58	CROMO-NIKEL SATINATO / Chrome - Glossy Black Nickel BUCKET
59	NERO OPACO + ORO OPACO / Matt black + matt gold BUCKET
60*	CROMO-NIKEL SATINATO / Chrome-nikel satin BUCKET
61*	NICKEL NERO SATINATO OPACO / Black matt satin nickel PROGETTO SARTORIA
62*	ORO ROSA SATINATO VERNICIATO OPACO / Matte painted satin rose gold PROGETTO SARTORIA
64*	RAME SATINATO CHIARO PERLA / Light satin pearl copper PROGETTO SARTORIA
65*	OTTONE NATURALE SATINATO VERNICIATO LUCIDO / Natural satin brass glossy painted PROGETTO SARTORIA
67**	ORO PVD / Gold PVD PROGETTO SARTORIA

68**	ORO LIGHT LUCIDO PVD / Polished light gold PVD PROGETTO SARTORIA
69**	ORO LIGHT SATINATO PVD / Satin light gold PVD PROGETTO SARTORIA
70**	RAME PVD / Copper PVD PROGETTO SARTORIA
71**	RAME SPAZZOLATO PVD / Copper brushed PVD PROGETTO SARTORIA
72**	NICHEL SATINATO PVD / Satin nickel PVD PROGETTO SARTORIA
73**	NICHEL NERO PVD / Black nickel PVD PROGETTO SARTORIA
79*	ORO ROSA SATINATO VERNICIATO PERLA / Satin rose gold painted pearl PROGETTO SARTORIA
88*	LONDON NIGHT LUCIDO PVD / Glossy PVD London Night PROGETTO SARTORIA
90*	NICHEL NERO VERNICIATO OPACO / Matte painted black nickel PROGETTO SARTORIA

HQC **PRODOTTI ESTERNO CON CONTROLLO DI QUALITÀ** / high quality control for external production / Produit externe avec contrôle de qualité / Externes Produkt mit Qualitätskontrolle / Внешний продукт с контролем качества

* **FINITURA DISPONIBILE IN 20 GG.**
Finish available in 20 days / Finition disponible en 20 jours
Oberfläche lieferbar in 20 Tagen / Отделка доступна в течение 20 дней

** **FINITURA DISPONIBILE IN 40 GG.**
Finish available in 40 days / Finition disponible en 40 jours
Oberfläche lieferbar in 40 Tagen / Отделка доступна в течение 40 дней

QUALITÀ GARANTITA

QUALITY GUARANTEED / QUALITÉ GARANTIE
QUALITÄT GARANTIE / КАЧЕСТВО GARANTEED

GARANZIA

La STILHAUS riconosce una garanzia di 5 ANNI (con decorrenza dalla data d'acquisto comprovata dalla ricevuta o scontrino fiscale) sui propri prodotti i sul catalogo e con apposito tagliando nella confezione. La garanzia comporta per STILHAUS unicamente l'obbligo di provvedere alla sostituzione dei prodotti riconosciuti difettosi con l'esclusione di ogni altra prestazione così come le spese di trasporto, l'indennizzo o risarcimento per danni diretti o indiretti. La garanzia è valida solo se le non conformità dichiarate sono riconducibili a difetti di fabbricazione, riconosciute da personale autorizzato dal costruttore e se le istruzioni d'uso siano state seguite correttamente. Sono esclusi dalla garanzia le parti soggette a normale usura e le parti e/o componenti che dovessero risultare difettosi o danneggiati a causa di danni accidentali per incuria o inadeguato trattamento, per uso ed installazione impropri, e da successive manipolazioni eseguite da personale non autorizzato dal costruttore e/o dalla loro esposizione ad agenti corrosivi e/o abrasivi anomali. Stilhaus Arredo Bagno declina qualsiasi responsabilità per eventuali danni a persone, animali o cose, causati da errori d'installazione o imperfetto utilizzo o dalla mancata osservanza di tutte le prescrizioni contenute nelle informazioni che accompagnano il prodotto. Per ogni controversia in merito, il Foro competente è quello di Viterbo.

PULIZIA

Tutte le parti che compongono il prodotto possono essere pulite utilizzando un panno morbido imbevuto di detergenti liquidi per la pulizia della casa a base neutra. Consigliamo di asciugare il prodotto dopo l'uso con un panno asciutto. Non usare assolutamente detersivi abrasivi, sostanze infiammabili chimicamente aggressive e altri solventi.

TOLLERANZE - Le illustrazioni dei nostri prodotti, deplianti e cataloghi, non costituiscono impegno di fedele riproduzione, la ditta si riserva il diritto di apportare modifiche ai propri prodotti senza l'obbligo di preavviso.

PRODUZIONE ARTIGIANALE DELLE CERAMICHE

I nostri articoli in ceramica sono realizzati manualmente per colaggio, senza l'utilizzo di stampi industriali, la presenza di piccoli punti è caratteristica dell'artigianalità del prodotto.

PRESTAZIONI ESTETICHE E METODI DI CONTROLLO:

Il controllo di qualità viene effettuato secondo le seguenti specifiche:

- Occhio nudo, corretto se necessario

Distanza

- Corrispondente all'uso standard e funzionale
- In posizione eretta, con 50 cm tra l'occhio l'oggetto.

Visibilità

- Corrispondente alle condizioni operative

Zone di visualizzazione:

I componenti dei nostri articoli sono soggetti alle zone di visualizzazione definite nella tabella seguente. Queste zone di osservazione riflettono il livello di criticità nei confronti dell'utente finale e determinano il livello di accettabilità dei difetti

Zona 1

sporco non ammesso- non più di 1 punto inferiore a dia. 1 mm – non più di 1 graffio inferiore a 3 mm

- una zona visibile in modo permanente.

oppure

- una zona alternativamente nascosta o visibile (ad esempio: interno scopino)

Zona 2

sporco non ammesso – non più di 2 punti inferiori a 2 mm –non più di 2 graffi inferiori a 5 mm

Definita come zona nascosta in modo permanente (ad es. Sotto di una ceramica, ecc.).

Tolleranze in millimetri, inferiore al 5 % della misura totale.

Specchi

- Eventuali difetti del vetro vanno individuati a 1,5 m di distanza con luce naturale.
- L'anti appannamento ha effetto nell'area centrale di utilizzo



WARRANTY

STILHAUS recognizes a 5-YEAR warranty (with effect from the date of purchase proven by the receipt) on its products in the catalog and with a special coupon in the package. The guarantee involves STILHAUS only the obligation to provide for the replacement of defective products with the exclusion of any other service as well as transport costs, compensation or compensation for direct or indirect damages. The warranty is valid only if the declared non-conformities are attributable to manufacturing defects, recognized by personnel authorized by the manufacturer and if the instructions for use have been followed correctly. Parts subject to normal wear and damage due to carelessness or inadequate installation or subsequent manipulations carried out by personnel not authorized by the manufacturer and / or their exposure to abnormal corrosive and / or abrasive agents are excluded from the guarantee. Stilhaus Arredo Bagno declines any for any damage to persons, animals or things, caused by installation errors or imperfect use or failure to comply with all the responsibilities contained in the information accompanying the product. For any dispute in this regard, the competent court is that of Viterbo.

CLEANING

All parts of the product can be cleaned with a soft soaked in neutral-based liquid household cleaning detergent. We recommend wiping the product after use with a dry cloth.

Never use abrasive detergents, chemically aggressive flammable substances and other solvents.

TOLERANCES - The illustrations of our products, brochures and catalogs are not committed to faithful reproduction, the company reserves the right to make changes to its products without prior notice.

ARTISAN PRODUCTION OF CERAMICS

Our ceramic items are made manually by casting, without the use of industrial molds, the presence of small points is characteristic of the product's craftsmanship.

AESTHETIC PERFORMANCE AND CONTROL METHODS:

Quality control is carried out according to the following specifications:

- Naked eye, corrected if necessary

Distance

- Corresponding to standard and functional use
- In an upright position, with 50 cm between the eye and the object.

Visibility

- Corresponding to the operating conditions

Display area:

The components of our items are subject to the display zones defined in the table below. These observation areas reflect the level of criticality in the comparisons to the end user and determine the level of acceptability of the defects

Zone 1 -

dirt not erased - no more than 1 point less than 1 mm diameter -no more than 1 scratch less than 3mm

- a permanently visible area.

or

- an alternately hidden or visible area (for example: internal toilet brush)

Zone 2

dirt not erased - no more than 2 points less than 2 mm - no more than 2 scratches less than 5mm

Defined as a permanently hidden area (eg under a ceramic, etc.).

Tolerances in millimeters, less than 5% of the total measurement.

Mirrors

- Any defects in the glass should be identified at a distance of 1.5 meters under natural light.
- The anti-fog effect is effective in the central area of use.

PERSONALIZZAZIONE LASER

LASER CUSTOMISATION / PERSONNALISATION DU LASER
LASERINDIVIDUALISIERUNG / ЛАЗЕРНАЯ ПЕРСОНАЛИЗАЦИЯ

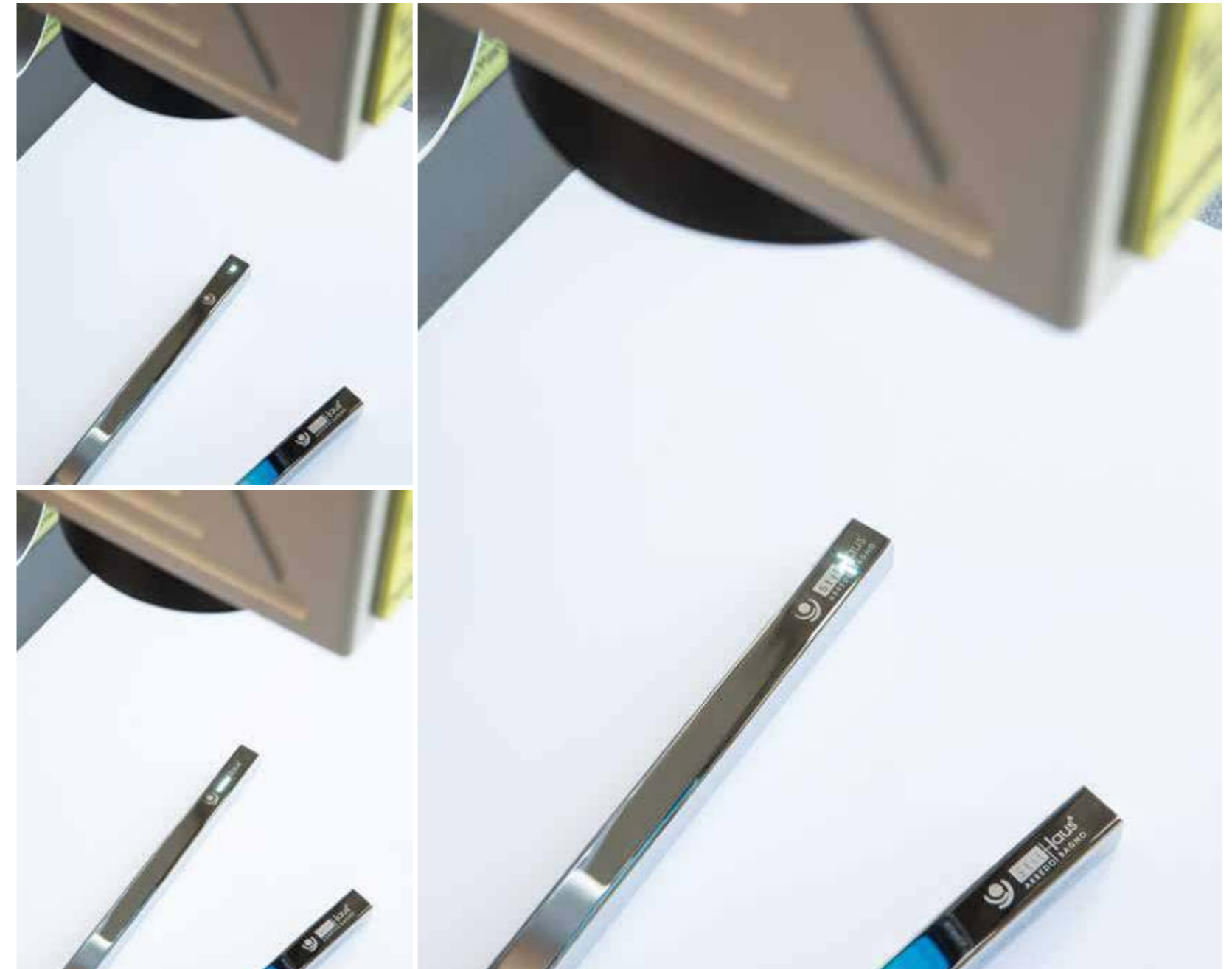

Possibilità di personalizzare accessori o prodotti con il logo o il nome della struttura alberghiera. Necessario l'invio di file in formato adatto (dxf o vectoriale).

Prezzo di listino € 2.50 a logo
Minimo 50 pezzi.

Accessories or products can be customized with the logo or name of the hotel. It is necessary to send files in a suitable format (dxf or vectorial).

List price € 2.50 per logo
Minimum 50 pieces

Possibilité de personnaliser des accessoires ou des produits avec le logo ou le nom de l'hôtel. Les fichiers doivent être envoyés dans un format approprié (dxf ou vectoriel).

Prix de liste : 2,50 € par logo
Minimum 50 pièces.

Möglichkeit der individuellen Gestaltung von Zubehör oder Produkten mit dem Logo oder Namen des Hotels. Die Dateien müssen in einem geeigneten Format (dxf oder Vektor) eingereicht werden.

Listenpreis € 2,50 pro Logo
Mindestens 50 Stück.

Возможность персонализация аксессуаров или продуктов с логотипом или названием отеля. Необходимо прислать файлы в подходящем формате (dxf или вектор).

Прейскурантная цена € 2,50 за логотип
Минимум 50 штук.

È vietata la riproduzione totale o parziale di foto e illustrazioni contenute in questo catalogo.
Partial total or of contained photos and illustrations in this catalogue is prohibited the reproduction.
Elle est défendue la reproduction totale ou partiel de photos et d'illustrations contenues dans ce je catalogue.
Запрещается полное или частичное воспроизведение фотографии и иллюстрации, содержащиеся в этом каталоге.



www.stilhaus.it



Stilhaus Arredo Bagno srl

Via della chimica, n°4 - 01100 Viterbo Italy

Tel. +39/0761.352736

www.stilhaus.it - e-mail: stilhaus@stilhaus.it

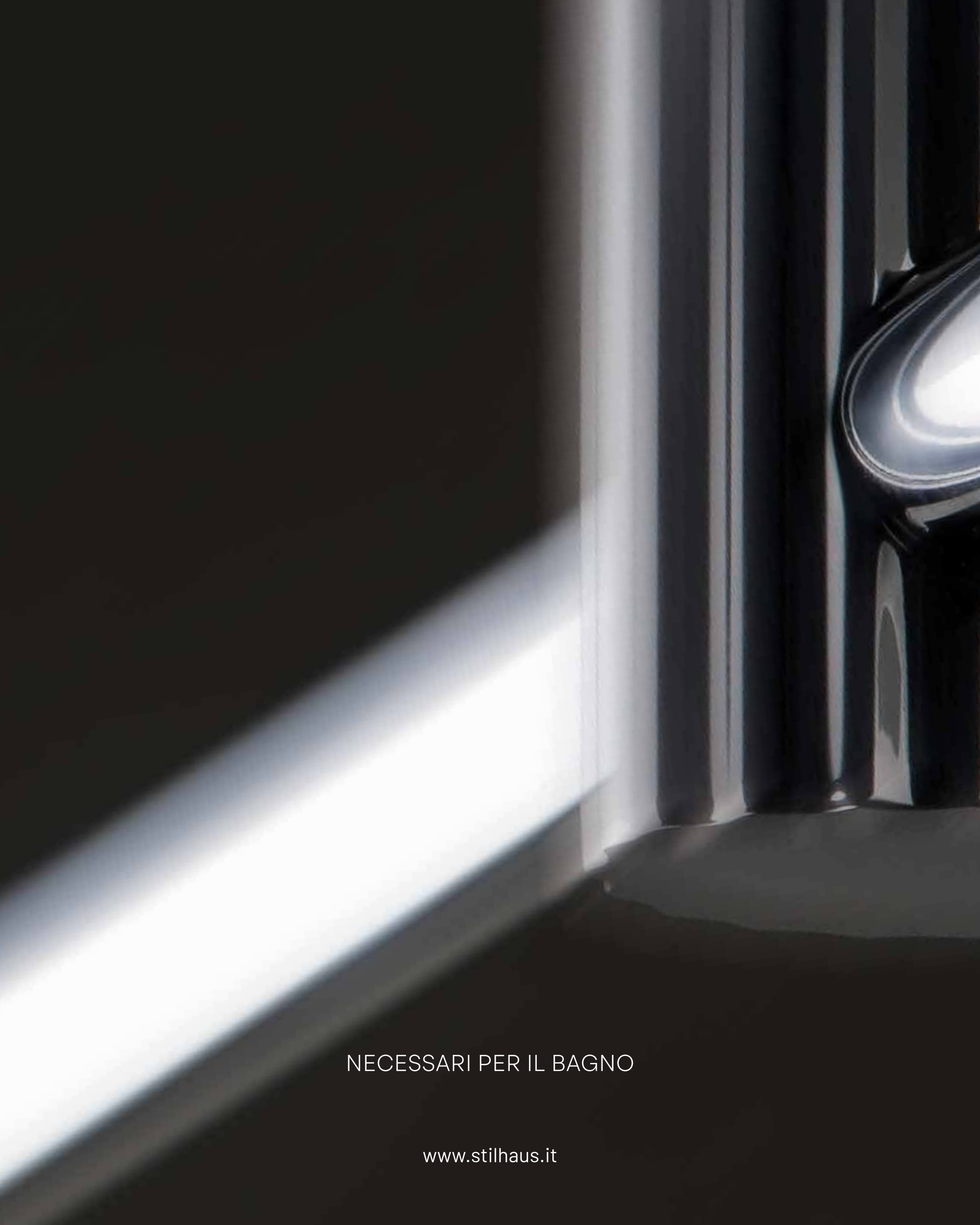

NECESSARI PER IL BAGNO

www.stilhaus.it